



# ESPECIAL 2021 KIT DE AFINAÇÃO

**FASANO**  
TOOLS

PORTUGAL - € IVA NÃO INCLUÍDA



## LONGO CAMINHO JUNTOS

A **FASANO TOOLS** sempre foi o seu partner ideal para para cada necessidade diária. Com uma gama de 150 diferentes kit de sincronização, qualquer veículo ou marca para operar, pode contar com a nossa proposta, com a garantia de qualidade e precisão e um serviço pós-venda sempre pontual e preciso.

Nossa linha é desenvolvida de forma cuidadosa e confiável, graças ao constante trabalho de Pesquisa e Desenvolvimento e uma Equipe técnica dedicada.

Com **FASANO TOOLS** sempre tem a possibilidade de comprar não só o kit completo, mas também todos os singles utensílios que o compõem, como se fosse um simples peças sobressalentes sempre disponíveis ao longo do tempo.

Experimente o nosso serviço de pesquisa rápida TOOL FINDER que encontrar na página web [www.fasanotools.com](http://www.fasanotools.com)

Em alguns momentos encontrará o kit certo para suas necessidades, com o garantia de um serviço especial de entrega rápida com base em um ampla rede de distribuição nacional.

**FASANO TOOLS: your professional partner**

FG 192/BW1

~~36,00€~~ 19,90€

EXTRATOR POLIA BOMBA  
DE INEÇÃO BMW

CÓDIGO MOTOR:  
M41, M51



FG 192/BW2

~~57,00€~~ 32,90€

EXTRATOR POLIA BOMBA  
DE INEÇÃO BMW

CÓDIGO MOTOR:  
M47, M47TU, M57, M57TU



FG 192/BW3

FERRAMENTA DE BLOQUEIO  
DO ÁRVORE BMW N47, N47S, N57

MODELOS:  
118D(E81/E87);120D(E81/E82/E87);123D(E81/E82/E87);  
318D(E90/E91); 320D(E90/E91/E92); 520D(E60/E); X3 2.0D(E83)

MOTOR: 1.6D, 2.0D, 3.0D

CÓDIGO MOTOR: N47, N47S, N57



~~52,00€~~ 29,90€

FG 192/BW4B

FERRAMENTA PARA EIXOS DE EQUILÍBRIO/  
CAMBOTA MOTORES BMW (N47/N47S)

MODELOS:  
118D(E81/E87);120D(E81/E82/E87);  
123D(E81/E82/E87); 318D(E90/E91);  
320D(E90/E91/E92); 520D(E60/E); X3 2.0D(E83)

MOTOR: 1.6D, 2.0D, 3.0D  
CÓDIGO MOTOR: N47, N47S, N57

~~370,00€~~ 209,00€



FG 192/BW4

KIT DE AFINAÇÃO BMW 2.0 N47,  
N47S, N57 COM CADEIA

MODELOS:  
118D(E81/E87);120D(E81/E82/E87);  
123D(E81/E82/E87); 318D(E90/E91);  
320D(E90/E91/E92); 520D(E60/E);  
X3 2.0D(E83)

MOTOR: 1.6D, 2.0D, 3.0D

CÓDIGO MOTOR: N47, N47S, N57

~~165,00€~~ 92,50€

### CONTEÚDO

FG 192/BW4-1 Ferramenta de alinhamento da árvore de cames  
FG 192/BW4-2 Ferramenta de rodagem da polia da cambota  
FG 192/BW4-3 Cavilha de sincronização da placa do volante  
FG 192/BW4-4 Ferramenta de remoção do carroto da bomba  
de alta pressão

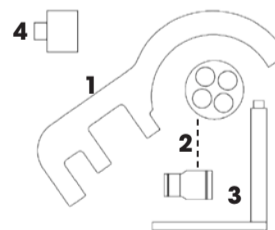

FG 192/BW16

BMW: Serie 1, Serie 2 Active Tourer, Serie 2 Cabriolet, Serie 2 Coupe, Serie 2  
Gran Tourer, Serie 3, Serie 3 Gran Turismo, Serie 4 Cabriolet, Serie 4 Coupe, Serie  
4 Gran Coupe, Serie 5, X1, X3, X4, X5

MINI: Clubman, Mini Hatch, Clubman, Convertible, Countryman

MOTOR::

2.0 D: 2.0 benzina

CÓDIGO MOTOR:

2.0 D: B47; B47 C20A; B47 C20B; B47 D20A; B47 D20B  
2.0 benzina: B48 A20A; B48 A20B; B48 B20A; B48 B20B

~~225,00€~~ 159,00€





# KIT DE AFINAÇÃO



FG 192/BW9B



## KIT DE AFINAÇÃO BMW-MINI B37/B47 1.5, 2.0 DIESEL (CADENA DE AFINAÇÃO)

MODELOS:

**BMW:** 214d; 216d; sDrive 16d; 114d; 116d; xDrive25d; 218d; 220d; sDrive 18d; xDrive 18d; xDrive 20d; 316d; 318d; 418d; 420d; 518d; 225d;  
**MINI:** Mini Hatch; One D; Convertible; Cooper D; Cooper SD

MOTOR: 1.5, 2.0

CÓDIGO MOTOR: B37 C15A; B37 D15A; B47 C20A; B47; B47 D20A; B47 D20B

~~470,00€~~ 269,00€

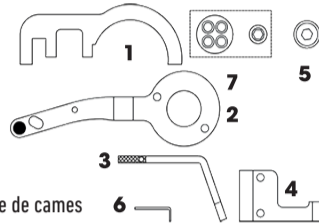

CONTEÚDO

- FG 192/BW4-1 Ferramenta alinhamento da árvore de cames
- FG 192/BW9B-2 Ferramenta de fixação da cambota
- FG 192/BW9B-3 Pino de sincronização da transmissão manual
- FG 192/BW9B-4 Placa de sincronização do prato de pressão da transmissão automática
- FG 192/BW4-4 Ferramenta de remoção do carreto da bomba de combustível
- FG 192/BW9B-6 Pino de bloqueio do tensor
- FG 192/BW4-2 Ferramenta de rotação da polia da cambota



FG 192/BW4C



## KIT DE ROTAÇÃO/FIXAÇÃO DA CAMBOTA BMW-MINI B37/B47 1.5, 2.0 DIESEL

~~140,00€~~ 79,90€



FG 192/BW15



## KIT DE AFINAÇÃO BMW-MINI B38/B48/B58 1.5, 2.0, 3.0 (CADENA DE AFINAÇÃO)

MODELOS:

**BMW:** 116i; 118i; 225xe; 218i; 220i; 225i; 120i; 125i; 320i; 330i; 420i; 430i; 530i; 520i; 730i; 740e iPerformance; sDrive 20i; xDrive 25i; 214d; 216d; sDrive 16d; 114d; xDrive25d; 218d; 220d; sDrive 18d; xDrive 18d; xDrive 20d; 316d; 318d; 418d; 420d; 518d; 225d; **MINI:** Mini Hatch; One D; Convertible; Cooper D; Cooper SD

MOTOR: 1.5, 2.0

CÓDIGO MOTOR: B38 A15A; B38 B15A; B38 K15A; B48 A20B; B48 B20A; B48 B20B; B48 A20A; B38 A12A

~~880,00€~~ 539,00€



FG 192/BW5



## KIT DE AFINAÇÃO BMW M47/M57, LAND ROVER 2.0 - 3.0 DIESEL TD4/TD6; OPEL 2.5 D

**BMW M47/M47TU:** 120d, 318d, 318td Compact, 320d, 520d, X3

**BMW M57/M57TU:**

330d, 335d, 530d, 535d, 635d, 730d, X3, X5, X5D Turbo, X6

**LAND ROVER:** Freelander (Td4) 2000-2006;

**RANGE ROVER:** Td6 (02-13)

**VAUXHALL/OPEL:** Omega-B (01-03)

MOTOR: 2.0; 2.5; 3.0 Diesel

CÓDIGO MOTOR: M47: 20 4D 1; M47TU: 20 4D 4 / M57: 306D1; M57: YD30T2, 204D3TD4 / M57TU: 306D2, 306D5, 306D1 / TD6: Y25DT

~~175,00€~~ 89,00€

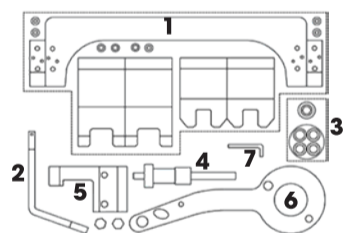

CONTEÚDO

- FG 192/BW15-1 Ferramenta alinhamento da árvore de cames
- FG 192/BW9B-3 Pino de sincronização volante/prato de pressão
- FG 192/BW4-2 Ferramenta de rotação da polia da cambota
- FG 192/M10-4 Ferramenta para pré-tensionar cadeia
- FG 192/BW9B-4 Adaptador do volante/prato de pressão
- FG 192/BW9B-2 Ferramenta de fixação da cambota
- FG 192/BW9B-6 Pino de bloqueio do tensor

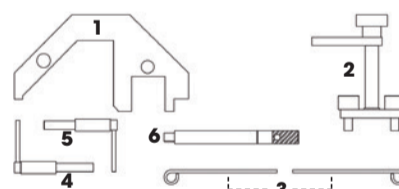

CONTEÚDO

- FG 192/BW5-1 Ferramenta de alinhamento da árvore de cames
- FG 192/BW5-2 Ferramenta para alinhamento da árvore de cames
- FG 192/BW5-3 Cavilhas de bloqueio do tensor (2 peças)
- FG 192/BW5-4 Ferramenta de bloqueio do volante do motor 1
- FG 192/BW5-5 Ferramenta de bloqueio do volante do motor 2
- FG 192/BW5-6 Ferramenta de bloqueio do volante do motor

FG 192/BW15A



~~32,00€~~ 19,00€

CHAVE PARA VÁLVULA DE AJUSTE DO DISPOSITIVO DE AJUSTE DA ÁRVORE DE CAMES PARA MOTORES BMW/MINI B38/B48 ENGINES



FG 192/BW4E



## FERRAMENTA DE TRAVAMENTO DO VIRABREQUIM DO MOTOR BMW/MINI N47/N47T/N47S (A PARTIR DE MAIO DE 2013)

MODELOS:

**BMW:** 123d; 116d; 316d; 118d; 120d; 220d; 118d xDrive; 120d xDrive; 218d; 316d; 318d; 420d; 520d; sDrive16d; sDrive18d  
**MINI:** Clubvan; Countryman; Mini; Paceman; Roadster; Clubman; Coupe;  
**MOTOR:** 1.6 Diesel; 2.0 Diesel

CÓDIGO MOTOR:

1.6 Diesel: N47 C16U1, N47 C16K1, N47 C16A/U1, N47 D16C, N47 D16 2.0 Diesel: N47 C20K1, N47 C20U1, N47 C20A/K1, N47S D20B/D/TO, N47 D20C/K1, N47 D20C, N47 D20C/U1, N47 D20C/O1, N47 D20D, N47 D20D/T1, N47T D20O1, N47 D20C/O, N47 D20A, N47 D20C/O1, N47 D20UO

~~105,00€~~ 59,00€



FG 192/BW6



## KIT DE AFINAÇÃO BMW N40, N45

MODELOS:

N40: (E46) 316i/316ti/316Ci  
N45: (E81/E87) 116i; (E90) 316i

MOTOR: 1.6

CÓDIGO MOTOR: N40 B16A; N45TB16AC, N45B16A

~~480,00€~~ 279,00€

CONTEÚDO

- FG 192/BW6-1 Ferramenta de ajuste da sonda VANOS
- FG 192/BW8-2 Cavilha de bloqueio do volante
- FG 192/M10-4 Ferramenta do tensor da correia
- FG 192/BW6-4 Ferramenta de bloqueio árvore de cames, entrada
- FG 192/BW6-5 Ferramenta de bloqueio da árvore de cames, escape
- FG 192/BW6-6 Parafusos de fixação

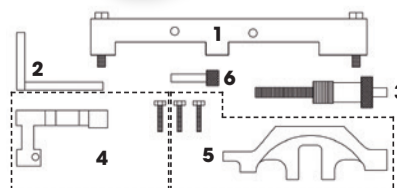



**FG 192/BW8**

**KIT DE AFINAÇÃO BMW N42, N46, N46T**

**MODELOS:**  
N42: (E46) 316i / 316ti / 318ti/318i  
N46: (E87) 118i / 120i; (E90/E91) 318i/320i; Z4 (E85)

**MOTOR:** 1.8, 2.0

**CÓDIGO MOTOR:**  
N42 B18A; N42 B20A;  
N46 B18; N46 B20; N46 B20B

**398,00€ 229,00€**

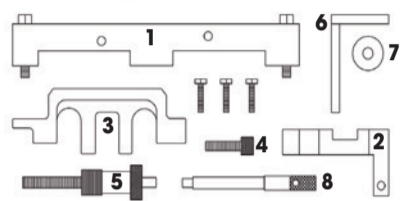

**CONTEÚDO**  
FG 192/BW8-1 Ferramenta alinhamento da engrenagem do sensor  
FG 192/BW8-2 Ferramenta alinhamento da árvore de cames entrada  
FG 192/BW8-3 Ferramenta alinhamento da árvore de cames,escape  
FG 192/BW8-4 Parafuso de orelhas  
FG 192/MI10-4 Ferramenta de pré-tensão da correa da distribuição  
FG 192/BW8-6 Ferramenta de bloqueio do volante do motor  
FG 192/BW8-7 Ferramenta de bloqueio do volante do motor  
FG 192/BW8-8 Grampos para alinhamento da árvore de cames



**FG 192/BW18**

**KIT DE AFINAÇÃO BMW VALVETRONIC**

**MODELOS:**  
N42: (E46) 316i / 316ti / 318ti/318i  
N46: (E87) 118i / 120i; (E90/E91) 318i/320i; Z4 (E85)

**MOTOR:** 1.8, 2.0

**CÓDIGO MOTOR:**  
N42 B18A; N42 B20A  
N46 B18; N46 B20; N46 B20B

**440,00€ 269,00€**

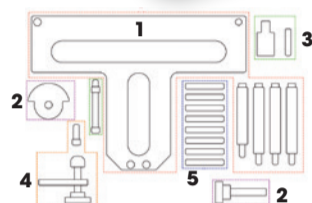

**CONTEÚDO**  
FG 192/BW18-1 Armação montagem do suporte árvore de cames  
FG 192/BW18-2 Ferramenta de fixação da árvore de cames de admissão (dianteira)  
FG 192/BW18-3 Instalador/extractor das molas de torção  
FG 192/BW18-4 Ferramenta de fixação da árvore de cames de admissão (traseira)  
FG 192/BW18-5 Conjunto de grampos de alavanca intermédios



**FG 192/BW7**

**KIT DE AFINAÇÃO BMW N62/N73**

**MODELOS:**  
N62: 540i, 545i, 550i (E60/61); 645i, 650i (E63/64), 735i, 740i, 745i 750i (E65/66), X5 (E53/E70)  
N73: 760i (E65/66)

**MOTOR:** 3.6-4.0-4.4-4.8

**CÓDIGO MOTOR:** N62 B40A; N62 B44A; N62 B48B; N62 B36A; N73 B60A

**350,00€ 209,00€**

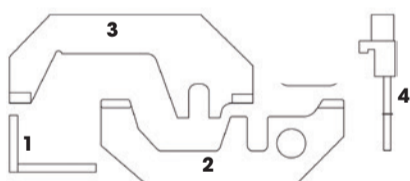

**CONTEÚDO**  
FG 192/BW8-6 Ferramenta de fixação da polia da cambota  
FG 192/BW7-2 Ferramenta de fixação árvore de cames, entrada  
FG 192/BW7-3 Ferramenta de fixação árvore de cames, escape  
FG 192/BW7-4 Parafuso de fixação árvore de cames



**FG 192/BW9**

**KIT DE AFINAÇÃO BMW N43 1.6 & 2.0**

**MODELOS:**  
116i; 118i; 120i; 316i; 318i; 320i; 520i

**MOTOR:** 1.6; 2.0

**CÓDIGO MOTOR:**  
N43 B16A/AA; N43 B16AA;  
N43 B20KO; N43 B20AY;  
N43 B20A; N43 B20AA;  
N43 B16AA/00; N43 B20U0

**498,00€ 319,00€**

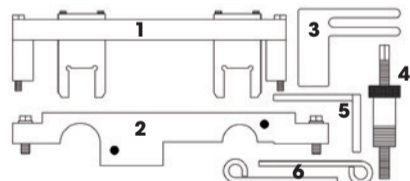

**CONTEÚDO**  
FG 192/BW9-1 Ferramenta de alinhamento da árvore de cames  
FG 192/BW9-2 Ferramenta de alinhamento do sensor VANOS da árvore de cames  
FG 192/BW9-3 Ferramenta de bloqueio do veio do equilibrador  
FG 192/MI10-4 Tensor da corrente de distribuição  
FG 192/BW8-6 Cavilha de distribuição do volante do motor  
FG 192/BW5-3 Cavilhas de bloqueio do tensor x 2



**FG 192/BW8B**

**KIT DE AFINAÇÃO BMW N13 E N18**

**MODELOS:**  
**BMW:** Serie 1 (114i; 116i; 118i); Serie 3 (316i; 320i)  
**MINI:** Clubman (Cooper S (R55)); Clubman (JCW (R55)); Countryman (Cooper / Cooper S (R60), JWC (R60)); Coupe (Cooper S / JCW (R58)); Mini (Cooper S (R56/R87); Paceman (Cooper / JCW (R61)); Roadstar (Cooper S/JCW(R59))

**MOTOR:** 1.6 benzina

**CÓDIGO MOTOR:** N13, B16A (cambio manuale), N18 B16A; N18 B16MO; N18 B16C; N18 B16A/MO; N18 B16C/TO

**280,00€ 159,00€**

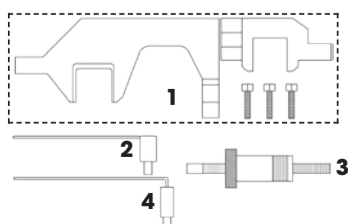

**CONTEÚDO**  
FG 192/BW8B-1 Ferramenta de alinhamento da árvore de cames + parafusos  
FG 192/BW8B-2 Ferramenta de posição de sincronização da cambota  
FG 192/MI10-4 Ferramenta do pré-tensor da corrente de distribuição  
FG 192/MI10-3 Ferramenta de posição de sincronização da cambota



**FG 192/BW8C**

**KIT DE AFINAÇÃO BMW N20 E N26**

**MODELOS:**  
Serie 1 (125i); Serie 3 (320i/xDrive; 328i/xDrive); Serie 5 (520i; 528i/xDrive); X1 (sDrive18i; sDrive20i; xDrive28i); X3 (xDrive20i; xDrive28i); Z4 (sDrive18i; sDrive20i; sDrive28i)

**MOTOR:** 2.0 benzina

**CÓDIGO MOTOR:** N20 B20A; N20 B20B/UO; N20; N26 B20

**430,00€ 259,00€**

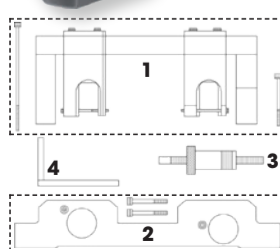

**CONTEÚDO**  
G 192/BW8C-1 Ponte de alinhamento da árvore de cames  
G 192/BW8C-2 Medidor de alinhamento da engrenagem do sensor  
G 192/MI10-4 Ferramenta do pré-tensor da corrente de distribuição  
G 192/BW8C-4 Pino de sincronização do volante

# KIT DE AFINAÇÃO



**CONTEÚDO**  
 FG 192/AF4-1 Ferramenta de tensão  
 FG 192/AF4-2 Ferramenta de tensão  
 FG 192/AF4-3 Parafuso de fixação do árvore de cames  
 FG 192/AF4-4 Parafuso de fixação do árvore de cames

**FG 192/AF4**

**KIT DE AFINAÇÃO  
 ALFA ROMEO  
 1.4, 1.6, 1.8 2.0**

**MODELOS:**  
 145, 146, 155, 156, 166, 147, GTV, Spider  
**MOTOR:** 1.4, 1.6, 1.8, 2.0 benzina  
**CÓDIGO MOTOR:**  
 162.01/323.01; 322.01; 335.03;  
 676.01; 41.03

~~182,50€~~ **109,00€**

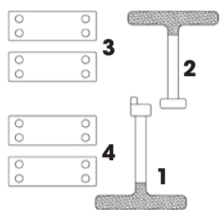

**FG 192/FT1**

**FERRAMENTA DE BLOQUEIO DO  
 VOLANTE DO MOTOR FIAT**

**MODELOS:**  
**FIAT:** Punto/Punto Classic;  
 Grande Punto; Punto Evo;  
 Palio Weekend; Stilo; Croma;  
 Multipla; Strada Pick-Up;  
 Marea; Marea Weekend; Sedici;  
 Doblo'; Doblo' Cargo;  
 Linea; Bravo  
**LANCIA:** Lybra; Musa; Delta  
**ALFA:** 145; 146; 147; 156; 159

**MOTOR:** 1.8 benzina, 1.6 Multijet, 1.9 JTD - 1.9 Multijet,  
 2.0, 2.4

~~35,00€~~ **19,90€**

**FG 192/AF4B**

**KIT DE AFINAÇÃO  
 ALFA ROMEO 1.75 TBI**

**MODELOS:**  
 159; BRERA; GIULIETTA;  
 SPIDER. LANCIA: DELTA  
**MOTOR:** 1,75 TBI; 1,75 DI Turbo  
**CÓDIGO MOTOR:**  
 939B1.000

~~225,00€~~ **129,00€**

**FG 192/AF2**

**KIT DE AFINAÇÃO  
 ALFA ROMEO 1.6 ECO 105 HP**

**MODELOS:** 147  
**MOTOR:** 1,6 Eco 105 Hp  
**CÓDIGO MOTOR:** 372.03

~~62,50€~~ **35,90€**

**FG 192/AF4C**

**KIT DE AFINAÇÃO  
 ALFA ROMEO 2.0 JTS 165 HP**

**MODELOS:** GT, 156  
**MOTOR:** 2.0 JTS  
**CÓDIGO MOTOR:** 932A2.000

~~95,00€~~ **59,00€**

**FG 192/FT4**

**FERRAMENTA DE BLOQUEIO DE BOMBAS DE  
 ÁGUA PARA MOTOR FIAT CROMA, OPEL**

**MODELOS:**  
**FIAT:** CROMA  
**OPEL:** ASTRA, VECTRA, VX220 SPEEDSTER,  
 ZAFIRA, SIGNUM,

**MOTOR:** 2.2 16V (benzina a catena)  
**CÓDIGO MOTOR:** 194A1.000; Z22SE; Z22YH

Permite de remover/installar a bomba de água  
 sem interferir com a corrente de distribuição

~~80,00€~~ **49,00€**

**FG 192/FT5**

**KIT DE AFINAÇÃO  
 FIAT 1.6 16V**

**MODELOS:**  
 Brava; Bravo; Marea; Multipla;  
 Stilo; Palio Weekend  
**MOTOR:** 1.6 16V  
**CÓDIGO MOTOR:** 178B3.000; 182A4.000;  
 182A6.000; 182B6.000

~~270,00€~~ **159,00€**

**FG 192/FT3**

**KIT DE AFINAÇÃO  
 FIAT CROMA, OPEL 2.2  
 16V**

**MODELOS:**  
**FIAT:** CROMA  
**OPEL:** ASTRA, VECTRA, VX220  
 SPEEDSTER, ZAFIRA, SIGNUM,  
**MOTOR:** 2.2 16V (benzina a catena)  
**CÓDIGO MOTOR:** 194A1.000; Z22SE; Z22YH

~~75,00€~~ **45,00€**



**FG 192/FT5A**

**FERRAMENTA DE BLOQUEIO DO VOLAN FIAT**

**MODELOS:** Brava; Bravo; Multipla  
**MOTOR:** 1.6 16V  
**CÓDIGO MOTOR:** 182B6.000, 182A4.000

~~16,50€~~ **7,90€**

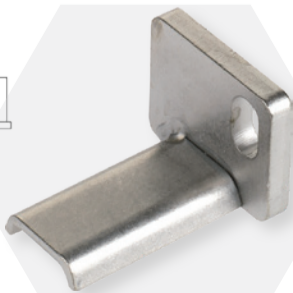
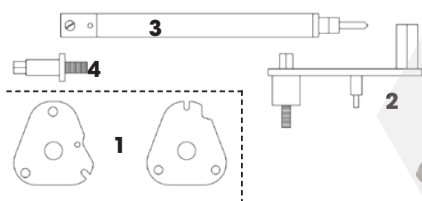



**FG 192/FT5B**

**KIT DE AFINAÇÃO FIAT 1.2/1.4 16V**

**MODELOS:**  
**FIAT:** Punto, Brava, Bravo, Marea, Stilo, Palio Weekend  
**LANCIA:** YPSILON, MUSA

**MOTOR:** 1.2 16V, 1.4 16V  
**CÓDIGO MOTOR:** 176B9.000; 182B2.000; 188A5.000; 843A1.000

**225,00€ 139,00€**

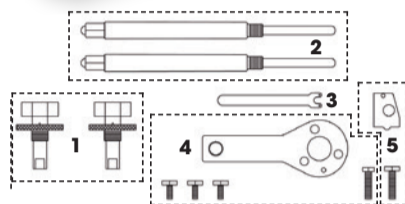

**CONTEÚDO**  
**FG 192/FT5B-1** Ferramenta de bloqueio árvore de cames (2)  
**FG 192/FT5B-2** Adaptador de altura do pistão (2)  
**FG 192/FT12-1** Ferramenta do tensor  
**FG 192/FT12-3** Ferramenta de bloqueio da cambota  
**FG 192/FT5B-5** Ferramenta de retenção do polie árvore de cames



**FG 192/FT7**

**KIT DE AFINAÇÃO FIAT, ALFA ROMEO, CHEVROLET, OPEL 1.6, 1.8**

**MODELOS:**  
**FIAT:** Cromia; **ALFA ROMEO:** 159;  
**CHEVROLET:** Aveo; Cruze  
**OPEL:** Corsa; Astra, Meriva, Zafira, Vectra, Signum, Insignia

**MOTOR:** 1.4, 1.6, 1.8 benzina  
**CÓDIGO MOTOR:** 939A4.000; G14D; LXV(F16D4); 2HO(Z18XER); Z16LEL; Z16LER; Z16LET; Z16XE1; Z16XEP; Z16XER; A16XER; A18XER; 2HO/A18XEL

**165,00€ 79,00€**

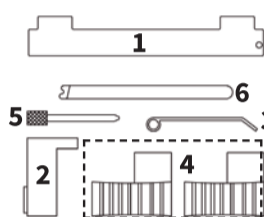

**CONTEÚDO**  
**192/FT7-1** Barra de bloqueio da árvore de cames  
**192/FT7-2** Ferramenta de bloqueio do volante do motor  
**192/FT7-3** Cavilha de bloqueio do tensor  
**192/FT7-4** Ferramenta de bloqueio do polie árvore de cames (2)  
**192/FT7-5** Cavilha de bloqueio  
**192/FT7-6** Ferramenta de bloqueio do volante do motor



**FG 192/FT12**

**KIT DE AFINAÇÃO FIAT 1.2 8V, 1.4 8V**

**MODELOS:**  
**FIAT** 500, Grande Punto, Doblo, Panda EVO2.  
**LANCIA** Musa

**MOTOR:** 1.2 8V / 1.4 8V  
**CÓDIGO MOTOR:** 169A4.000 - 199A4.000 - 350A1.000

**285,00€ 159,00€**

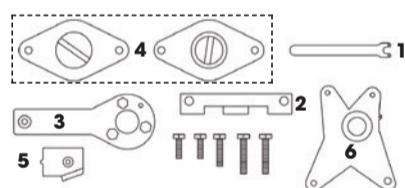

**CONTEÚDO**  
**FG 192/FT12-1** Ferramenta de tensão  
**FG 192/FT12-2** Suporte de fixação da árvore de cames  
**FG 192/FT12-3** Ferramenta de bloqueio da cambota  
**FG 192/FT12-4** Ferramenta de alinhamento da árvore de cames  
**FG 192/FT12-5** Ferramenta de bloqueio do carreto árvore de cames  
**FG 192/FT12-6** Ferramenta de alinhamento do tampa árvore cames



**FG 192/FT6**

**KIT DE AFINAÇÃO FIAT 1.3 MULTIJET, 1.3 CDTI, 1.3 DDIS**

**MODELOS:**  
**FIAT:** Panda, Punto, Idea, Doblo. **LANCIA:** Musa, Ypsilon  
**OPEL:** Agila, Corsa, Combo, Tigra, Meriva, Astra  
**SUZUKI:** Ignis, Swift

**MOTOR:** 1.3 Multijet, 1.3 CDTi, 1.3 DDIS  
**CÓDIGO MOTOR:** 188A8.000; 188A9.000; 199A2.000; 199A3.000; 169A1.000; 223A9.000; Z13DT; Z13 DTH

**230,00€ 135,00€**

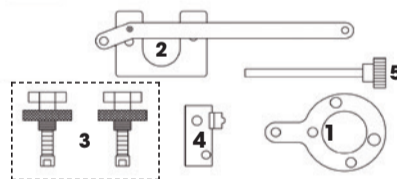

**CONTEÚDO**  
**FG 192/FT6-1** Ferramenta de posição de sincronização do cambota  
**FG 192/FT6-2** Alavanca de tensão da correia de distribuição  
**FG 192/FT6-3** Ferramenta de bloqueio da árvore de cames (2)  
**FG 192/FT6-4** Ferramenta de bloqueio do volante  
**FG 192/FT6-5** Bloqueio da cambota 8mm



**NEW FG 192/FT2**

**FERRAMENTA DE BLOQUEIO DE ARVORE DE CAMES FIAT 1.3 MULTIJET, 1.3 CDTI**

**MODELOS:**  
**FIAT:** 500/500X, Grande Punto, Punto, Doblò, Panda, Idea  
**OPEL:** Corsa-E  
**MOTOR:** 1.3 Multijet, 1.3 CDTi  
**CÓDIGO MOTOR:** 188A8.000; 188A9.000; 199A2.000; 199A3.000; 169A1.000; 223A9.000; LKU/B13DTE; LKV/B13DTC; LKU/B13DTR

**50,00€ 32,00€**



**FG 192/FT6A**

**FERRAMENTA DE BLOQUEIO DEL ÁRBOL DE CAMIONES DEL MOTOR FIAT 1.3 MULTIJET**

**MODELOS:**  
 Punto; Grande Punto; Punto Evo; Fiorino; Panda/Panda Classic; 500/500C; Doblò; Doblò Cargo; Qubo  
**MOTOR:** 1.3 JTDM; 1.3 JTDM; 1.3 MultiJet 75; 1.3 MultiJet 85; 1.3 MultiJet 90; 1.3 MultiJet 95  
**CÓDIGO MOTOR:** 199A3.000; 199B1.000; 199B4.000; 169A1.000; 223A9.000; 263A2.000

**105,00€ 65,00€**



**FG 192/FT6B**

**KIT DE AFINAÇÃO FIAT 1.6 - 1.9 JTD 16V**

**MODELOS:**  
**ALFA:** 147, 156, 159, GT.  
**FIAT:** Bravo, Cromia

**MOTOR:** 1.9 JTD 16V, 1.9 JTDM 16V  
**CÓDIGO MOTOR:** 192A5.000; 937A5.000; 192B1.000; 939A2.000

**160,00€ 99,00€**

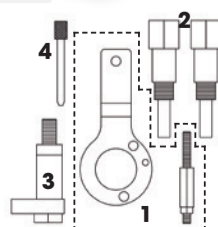

**CONTEÚDO**  
**FG 192/FT6B-1** Ferramenta de sincronização da cambota  
**FG 192/FT6B-2** Ferramentas de bloqueio da árvore de cames (2)  
**FG 192/FT17-4** Ferramenta de bloqueio do volante  
**FG 192/FT6B-4** Cavilha de bloqueio

# KIT DE AFINAÇÃO

FG 192/FT5C



## KIT DE AFINAÇÃO FIAT 2.3JTD

**MODELOS:** FIAT DUCATO, IVECO DAILY

**MOTOR:** 2.3D JTD, 2.3D-3.0D Multijet, 2.3D HPI; 3.0 HPI

**CÓDIGO MOTOR:** F1AE0481C; F1AE0481A; F1AE0481B; F1AE0481H; F1AE0481F; F1AE0481G; F1AE0481R; F1AE0481FA; F1AE0481HA; F1AE0481UA; F1AE0481VA; F1AE0481D; F1AE0481N; F1AE0481E; F1CE3481N; F1CE3481M; F1CE0481D; F1CE3481E; F1CE3481A; F1CE3481B; F1CE3481H; F1CE3481F

~~130,00€~~ 69,00€

### CONTEÚDO

- FG 192/FT5C-1 Cavilhas de sincronização da cambota
- FG 192/FT5C-2 Cavilha de sincronização da cambota
- FG 192/FT5C-3 Cavilhas de sincronização árvore decames
- FG 192/FT17-12 Cavilha de alinhamento carreto árvore de cames

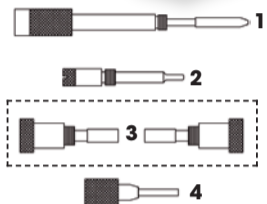

FG 192/FT6C



## KIT DE AFINAÇÃO FIAT TWINAIR

**MODELOS:** 500/500C (07-); Panda (2012)

**MOTOR:** 900 Twinair Turbo

**CÓDIGO MOTOR:** 312A2.000

~~145,00€~~ 89,00€

### CONTEÚDO

- FG 192/FT6C-1 Prato de bloqueio árvore de cames com parafusos
- FG 192/FT6C-2 Cavilha de bloqueio da polie
- FG 192/FT6C-3 Ferramenta de bloqueio do volante do motor

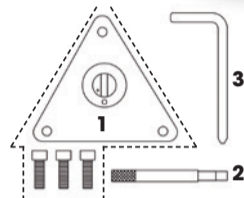

FG 192/JTD



## FERRAMENTA PARA TENSIONAR A CORREIA DENTADA DO MOTOR JTD MULTIJET

Alfa Romeo: 145, 146, 147, 156, 159, 166, Brera, Giulietta, GT, Mito, Spider Fiat: 500L, 500X, Brava, Bravo, Cromia, Doblò, Ducato, Freemont, Grande Punto, Idea, Marea, Multipla, Punto, StiloLancia: Delta, Kappa, Lybra, Musa, Thesis Saab: 9-3, 9-5 Suzuki: SX4

**MOTOR:** 1.6 JTD, 1.9 JTD/JTDM; 2.0 JTD; 2.4 JTD; 1.6 D; 2.0 D; 1.9 D; 1.9 CDTi; 2.0 CDTi; 1.9 TiD/TTiD; 2.0 TiD; 2.2 TTiD; 1.9 DDiS

~~78,00€~~ 45,00€

FG 192/FT10



## KIT DE AFINAÇÃO MULTIAIR

**MODELOS:**

Punto EVO, Punto EVO Abarth, Bravo, 500 Alfa MITO, Giulietta

**MOTOR:** 1.4 Multiair 16V

**CÓDIGO MOTOR:** 940A2.000, 955A6.000, 955A2.000, 955A7.000, 955A8.000, 198A7.000

~~135,00€~~ 75,00€

### CONTEÚDO

- FG 192/FT10-1 Prato de bloqueio da árvore de cames
- FG 192/FT12-1 Ferramenta de bloqueio da cambota
- FG 192/FT10-3 Ferramenta de tensão

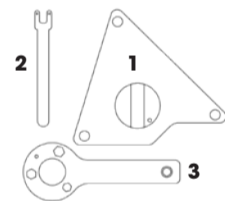

FG 192/FT16



## KIT DE AFINAÇÃO FIAT TWINAIR E MULTIAIR

**MODELOS:** 500/500C (07-); Panda (2012), Punto EVO, Punto EVO Abarth, Bravo, 500, Alfa MITO, Giulietta

**MOTOR:** 900 Twinair Turbo, 1.4 Multiair 16V

**CÓDIGO MOTOR:** 312A2.000, 940A2.000, 955A6.000, 955A2.000, 955A7.000, 955A8.000, 198A7.000

~~280,00€~~ 165,00€

### CONTEÚDO

- FG 192/FT10-1 Prato de bloqueio da árvore de cames
- FG 192/FT12-1 Ferramenta de bloqueio da cambota
- FG 192/FT10-3 Ferramenta de tensão

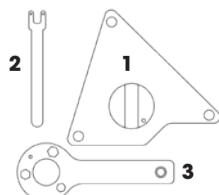

FG 192/FT6D



## FERRAMENTA DE ALINHAMENTO DE EIXOS DE EQUILÍBRIO FIAT TWINAIR

**MODELOS:** Ypsilon, 500, 500C, 500L, Punto, Panda, Mito

**MOTOR:** 900 Twinair, 900 Twinair Turbo

**CÓDIGO MOTOR:** 312A5.000, 312A2.000, 199B6.000, 312A7.000

~~88,00€~~ 49,90€

FG 192/FT10C



## FERRAMENTA PARA COMPRESSÃO MOLAS DO MÓDULO MULTIAIR E MULTIAIR TURBO

**MODELOS:** Punto EVO, Punto EVO Abarth, Bravo, 500, Alfa MITO, Giulietta, Lancia Delta

**MOTOR:** 1.4 Multiair 16V

**CÓDIGO MOTOR:** 940A2.000, 955A6.000, 955A2.000, 955A7.000, 955A8.000, 198A7.000

~~410,00€~~ 259,00€

### CONTEÚDO

- FG 192/FT6C-1 Prato de bloqueio árvore de cames com parafusos
- FG 192/FT6C-2 Cavilha de bloqueio da polie
- FG 192/FT6C-3 Ferramenta de bloqueio do volante do motor

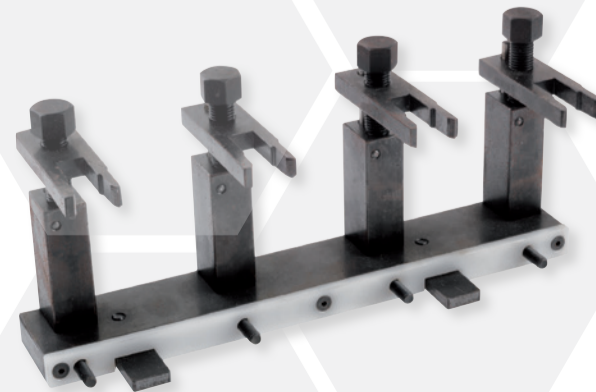
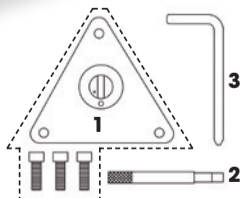



FG 192/FT17

KIT DE AFINAÇÃO FIAT, IVECO, FORD, PEUGEOT, CITROEN

**MODELOS:** FIAT: Ducato, IVECO: Daily, **CITROEN:** Relay/Jumper III  
**PEUGEOT:** Boxer III, FORD: Transit Van  
**MOTOR:** 2.2 - 2.3 - 3.0 JTD MJ (catena o cinghia)  
**CÓDIGO MOTOR:** 4HU(P22DTE); 4HV(P22DTE); P8FA; P8FB; QVFA; QWFA;SRFA; SRFB;SRFC; SRFD; SRFE; PGFA; PGFB; F1AE0481A/B/C/D/E/F/FA/G/H/HA/N/R/UA/VA F1CE3481A/B/E/F/H/M

590,80€ 369,00€

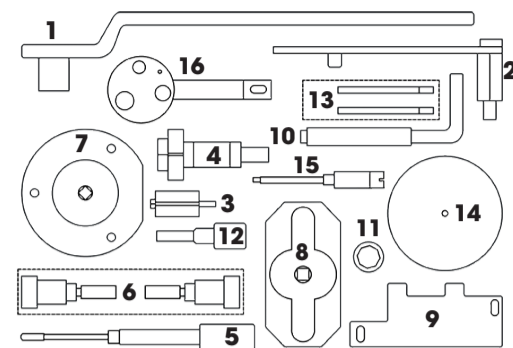

CONTEÚDO

- FG 192/FT17-1 Ferramenta de polia da cambota (2.2 MJ)
- FG 192/FT17-2 Ferramenta de fixação da polia da cambota (2.2 MJ)
- FG 192/FT17-3 Ferramenta de bloqueio do volante (2.3 MJ)
- FG 192/FT17-4 Ferramenta de bloqueio do volante (3.0 MJ)
- FG 192/FT17-5 Cavilhas de sincronização da cambota (2.3 - 3.0 MJ)
- FG 192/FT17-6 Cavilhas de sincronização da árvore de cames(2.3- 3.0MJ)
- FG 192/FT17-7 Ferramenta de desmontagem (2.2 MJ)
- FG 192/FT17-8 Ferramenta de sincronização da cambota (3.0 MJ)
- FG 192/FT17-9 Placa de centrando da bomba de óleo (2.2 MJ)
- FG 192/FT17-10 Cavilhas de sincronização da árvore de cambota(2.2MJ)
- FG 192/FT17-11 Ferramenta para instalar sensor de água (2.2 MJ)
- FG 192/FT17-12 Cavilha de alinhamento do carreto árvore cames (2.3 MJ)
- FG 192/FT17-13 Ferramenta de bloqueio da polie árvore cames (2.2 MJ)
- FG 192/FT17-14 Ferramenta de desmontagem (2.2 MJ)
- FG 192/FT17-15 Cavilha de sincronização da cambota (2.3 MJ)
- FG 192/FT17-16 Cavilha de sincronização da cambota (2.3 MJ)



FG 192/F016

KIT DE AFINAÇÃO FORD 1.0 ECOBOOST

**MODELOS:** B-MAX; Fiesta; C-MAX; Grand C-MAX; Focus; EcoSport;  
**MOTOR:** 1.0 EcoBoost; 1.0 SCTi EcoBoost  
**CÓDIGO MOTOR:** SFJA; SFJB; M1DA; M2DA; M1JC; M1JE; P4JA; P4JB

598,80€ 379,00€

FG 192/F016A

HERRAMIENTA DE DESMONTAJE / MONTAJE PARA EL TORNILLO POLEA DEL CIGÜEÑAL FORD 1.0 ECOBOOST

**MODELOS:** B-MAX; Fiesta; C-MAX; Grand C-MAX; Focus; EcoSport;  
**MOTOR:** 1.0 EcoBoost; 1.0 SCTi EcoBoost  
**CÓDIGO MOTOR:** SFJA; SFJB; M1DA; M2DA; M1JC; M1JE; P4JA; P4JB

1.298,80€ 799,00€



CONTEÚDO

- FG 192/F016-1/1 Ferramenta sincronização árvore de cames - grande
- FG 192/F016-1/2 Ferramentas sincronização árvore de cames - pequeno
- FG 192/F016-1/3 Parafusos para FG 192/F016-1 (8 peças)
- FG 192/F016-2/1 Ferramenta de alinhamento da árvore de cames - admissão
- FG 192/F016-2/2 Ferramenta de alinhamento da árvore de cames - escape
- FG 192/F016-3 Ferramenta de sincronização da cambota
- FG 192/F016-4 Ferramenta de bloqueio do volante
- FG 192/VW7-5 Ferramenta de bloqueio do carreto
- FG 192/F024-21 Ferramenta de alinhamento polia da cambota

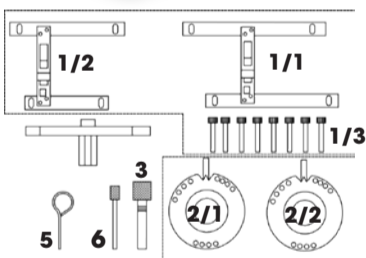

FG 192/F016B

KIT DE AFINAÇÃO FORD 2.0 ECOBOOST

**MODELOS:** Focus, Mondeo, Galaxy, S-Max  
**MOTOR:** 2.0 Ti-VCT; 2.0 SCTi EcoBoost; 2.0 EcoBoost  
**CÓDIGO MOTOR:** MGDA; TNBA; TNBB; TNWA; TNWB; TPBA; TPWA; XQDA; R9CB; R9CF; R9CH; TNCC; TNCD; TNCF

185,80€ 109,00€

CONTEÚDO

- FG 192/F016B-1 Placa de alinhamento da árvore de cames
- FG 192/F016B-2 Placa de alinhamento da árvore de cames
- FG 192/F016B-3 Pino de alinhamento da posição da cambota
- FG 192/F04-2 Pino de sincronização da cambota
- FG 192/F016B-5 Pino de 2 mm do tensor 2 mm

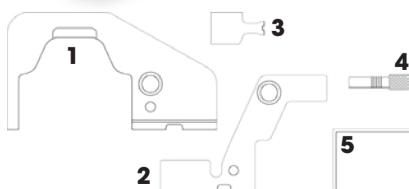

FG 192/F04

KIT DE AFINAÇÃO FORD 1.6 TI-VCT, 2.0 TDCI

**MODELOS:** C-MAX ; Focus ; Focus C-Max ; Kuga; B-MAX ; Fiesta ; Mondeo ; S-Max; Galaxy ; Grand-Cmax  
**MOTOR:** 1.6 / 1.6 Ti-VCT (benzina); 2.0 TDCI  
**CÓDIGO MOTOR:** HXDA; G6DA; G6DB; G6DC; IQJA; HXDB; SIDA; JQDA; JQDB; JTDA; JTDB; IQDB; PNDA; XTDA; MUDA; HXJA; HXJB; RVJA; U5JA; JTBA; JTBB; KGBA; PNBA; RHBA; JTWA; JTWB; G6DD; G6DE; G6DF; G6DG; IXDA; TXDA; TXDB; TYDA; UKDB; UFWA; TYWA; UFDB; QXWB;

185,80€ 119,00€

FG 192/F04A

FERRAMENTA DE ALINHAMENTO ÁRVORE DE CAMES FORD 1.6 ECOBOOST

**MODELOS:** B-Max; C-Max; Fiesta; Focus; Galaxy; Gran C-Max; Kuga; Mondeo; S-Max; Tourneo Connect; Transit Connect  
**MOTOR:** 1.6 ECOBOOST  
**CÓDIGO MOTOR:** JQMA; JQMB; JTMA; IQJA; JQDA; IQDA; JTWA; JTWB; KGBA



70,80€ 39,00€

# KIT DE AFINAÇÃO



## FG 192/F015

### DISPOSITIVO DE AFINAÇÃO FORD 2.0 ECOBLUE DIESEL TDCI

**MODELOS:** Transit; Transit Custom; Tourneo Custom  
**MOTOR:** 2.0 EcoBlue TDCi (dal 2016 in poi)  
**CÓDIGO MOTOR:** YLFS; YLF6; YLR6; YMF6; YMFS; YMR6; YNF6; YNFS; YNR6

~~575,00€~~ **349,00€**



## FG 192/F015A

### KIT PARA REMOÇÃO/INSTALAÇÃO BOMBA FORD 2.0 ECOBLUE DIESEL TDCI

**MODELOS:** Transit; Transit Custom; Tourneo Custom  
**MOTOR:** 2.0 EcoBlue TDCi (dal 2016 in poi)  
**Código motor:** YLFS; YLF6; YLR6; YMF6; YMFS; YMR6; YNF6; YNFS; YNR6

~~285,00€~~ **179,00€**



## FG 192/F06

### KIT DE AFINAÇÃO FORD 1.4/1.6 TDCI, VOLVO 1.6/2.0, CITROËN 1.6/2.0/2.2 HDI, FIAT 1.6/2.0/2.2 MULTIJET

**MODELOS:**  
**FORD:** C-MAX, Fiesta, Focus, Focus C-MAX  
**CITROËN:** Dispatch/Jumpy III, C4, C4 Picasso/Grand Picasso, C5 II, C5 III, C6, C8  
**FIAT:** Scudo  
**VOLVO:** C30, C70, S40, S80, V50, V70 D4164T, D4164T DRIVE, D4204T, D4204T2  
**CÓDIGO MOTOR:**  
 - G8DA, G8DB, G8DC, G8DD, G8DE, G8DF, HHDA, HHDB, F6JA, F6JB, F6JC, HHJA, HHJB, HHJC, HHJD: HHJE, HHJF  
 - 9HU (DV6UTED4), 4HP (DW12BTED4), 4HR (DW12BTED4), 4HR (DW12BTED4), 4HS (DW12BTED4), 4HT (DW12BTED4), RHK (DW10UTED4), RHR (DW10BTED4)  
 - 9H07, 9HU (DV6UTED4), RHK (DW10UTED4), RHR DW10BTED4)  
 - D4164T, D4164T DRIVE, D4204T, D4204T2  
**MOTOR:** -1.4, 1.6 TDCi /1.6 HDi, 2.0 HDi, 2.2 HDi / 1.6, 2.0, 2.2 Multijet / 1.6, 2.0

~~90,00€~~ **49,90€**



## FG 192/F07C

### KIT PARA BLOQUEAR O EIXO DE EQUILIBRIO DO MOTOR FORD, LAND ROVER 2.2 D

**MODELOS:** FORD: Galaxy, S-Max, Mondeo  
**LAND ROVER:** Freelander 2; Range Rover Evoque; Discovery Sport  
**MOTOR:** 2.2  
**CÓDIGO MOTOR:** KNWA; Q4BA; Q4WA; DW12CTED4; 224DT

~~118,00€~~ **69,90€**



## FG 192/F07

### KIT DE AFINAÇÃO FORD TRANSIT 2.2 TDCI

**MODELOS:** Ford Transit  
**MOTOR:** 2.2 TDCI  
**CÓDIGO MOTOR:** CYFA; CYFB; DRFA; USR6; SRFA; SRFB; SRFC; SRFD; SRFE; UHFA; QVFA; QWFA; PGFA; PGFB

**CONTEÚDO**  
 FG 192/PS15-8 Pinos de sincronização da árvore de cames de 6mm  
 FG 192/F024-20 Pino de alinhamento da cambota  
 FG 192/F07-3 Ferramenta de bloqueio do carreto da cambota

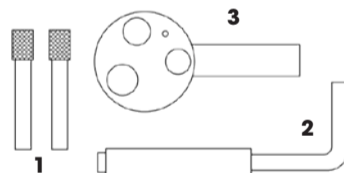

~~100,00€~~ **59,90€**

## FG 192/F07E

### FERRAMENTA DE TRAVA DO EIXO DO MOTOR FORD 2.2 TDCI

**CÓDIGO MOTOR:** CYRA; CVRA; CVRB; DRRR; DRRB; USRA; USRB

~~32,00€~~ **19,00€**



## FG 192/F024

### KIT DE AFINAÇÃO FORD/MAZDA

**MODELOS:**  
**FORD:** C, Max, Fiesta, Focus, Focus C, Max, Fusion, Transit Connect, Tourneo Connect, Cougar, Puma, Escort, Mondeo, Orion, Kombi, Galaxy  
**MAZDA:** 121(ZQ), 2(DY), 2(DE)  
**MOTOR:** 1.25, 1.4, 1.6, 1.8, 2.0, 2.9, 1.4D, 1.6D, 1.8D, 1.9D, 2.0D, 1.8D Turbo, 1.8 XR2i, 1.8 TDDi, 1.8D TDCi, 1.4D TDCi, 1.6 TDCi, 1.9 TDI, 1.9D TDI PD, 2.0D TDCi, 2.0 SR150, 2.5 DI/Turbo/TCI  
**CÓDIGO MOTOR:** AFN, AHU, ANU, A0BA, A0DA, A0DB, A0WA, ASZ, ASZ1, AUY, AZWA, BHDA/B, BHPA, B4A, B4B/B4C, BOA, BRC, BRD/BRE/BRF, BRG, BRV, C9DA/B, C9DC, DHA, DHB, DHC, DHD, EAB, EBDA/C, EDBB, EDBD, EDDC, EDDO, EDDF, EYDB, EYDC, EYDD/E, EYDF, EYDG, EYDI, EYDJ, EYPA, EYPCFHA, F6JA, F6JB, F8JA, F8JB, F9DA/B, FHD, FHF, FUJA, FUJB, FXJA, FXJB, FYJA, FYJB, FXDA/C, FYDA/C, FYDB/D, G6DA, G6DB, G6DC, G8DA, G8DB, HCPA, HCPB, HHDA, HHDB, HHJA, HHJB, HJBA, HJBB, HJBC, HJBE, HWDA, HWDB, KKDA, L1T, L1V, L1E, L1G, L1H, L1Y, L1K, L1L, L1N/Q, L1W, L1F, LTA/LTC, LTB, MHA, M7JA, M7JB, N4JB, NGA, NGB, NGC, NGD, QQDA, QQDB, QQDC, RDA, RDB, RKC, RKF, RKH, RHJ, RKK, RKA, RKB, RQB, RQC, RDF, RDK, RFM, RFN, RTA, RTB, RTC, RTD, RTE, RTF, RTG, RTH, RTJ, RTK, RTN/RTQ, RTP, RVA, RKD, 1Z, 4AB, 4BC, 4CA, 4CC, 4DA, 4EA, 4FA, 4GA, 4EB, 4EC, 4ED, 4FB, 4FC, 4FD, 4GA, 4GB, 4GC, 4GD, 4GE, 4HB

~~265,00€~~ **159,00€**

## FG 192/F07B

### FERRAMENTA DE RETENÇÃO DO CAMBOTA

~~120,00€~~ **69,90€**

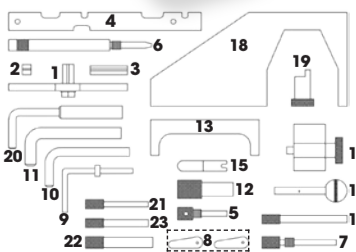

**CONTEÚDO**  
 FG 192/F024-1 Ferramenta de bloqueio do volante  
 FG 192/F024-2 Adaptador da ferramenta de bloqueio volante  
 FG 192/F024-3 Adaptador da ferramenta de bloqueio volante  
 FG 192/F024-4 Cavilhas de sincronização da árvore de cames  
 FG 192/F024-5 Cavilhas de sincronização da cambota  
 FG 192/F024-6 Cavilha de sincronização  
 FG 192/F024-7 Cavilhas de sincronização da árvore de cames  
 FG 192/F024-8 Cavilhas de sincronização da árvore de cames (Ø9,5mm)

FG 192/F024-9 Cavilhas de sincronização da árvore de cames  
 FG 192/F024-10 Cavilhas de sincronização da árvore de cames  
 FG 192/F024-11 Ferramenta de bloqueio do volante  
 FG 192/F024-12 Cavilha de fixação da bomba de injeção  
 FG 192/F024-13 Cavilha de sincronização da cambota  
 FG 192/F024-14 Pino de bloqueio da bomba de injeção  
 FG 192/F024-15 Forquilha de Tensão  
 FG 192/F024-16 Pino de fixação

FG 192/F024-17 Ferramenta de fixação da cambota  
 FG 192/F024-18 Placa de bloqueio da árvore de cames  
 FG 192/F024-19 Cavilhas de sincronização da árvore de cambota  
 FG 192/F024-20 Ferramenta de bloqueio do volante  
 FG 192/F024-21 Ferramenta de fixação da cambota  
 FG 192/F024-22 Ferramenta de bloqueio do volante  
 FG 192/F024-23 Ferramenta de sincronização da árvore de cames



FG 192/F03



FERRAMENTA DE BLOQUEIO VOLANTE DOS MOTOR FORD

DIESEL, GASOLINA - CARROCERÍA Y CADENA

~~50,00€~~ 29,90€



FG 192/F08



KIT DE AFINAÇÃO FORD ZETEC E DURATEC

MODELOS:

FORD: Fiesta, Fusion, Courier, Escort, Focus, Puma, Mondeo, Transit, Connect, CougarOrion, Kombi, Galaxy

MAZDA: 121 benzina

VOLVO: S40, V50 benzina

MOTOR: 1.2,2.4,1.6,1.6 16V, 1.7 16 cinghia, 1.8D, 1.8TD, 1.8 e 2.0 16V cinghia e catena

CÓDIGO MOTOR: DHA, DHB, DHC, DHD, DHE, DHE, DHG, FHA, FHE, 4HA

~~85,00€~~ 49,90€



FG 192/F011



KIT DE AFINAÇÃO FORD 2.0, 2.2, 2.4, DURATORQ 16V

MODELOS: Mondeo, Transit, Focus

MOTOR: 2.0, 2.2 & 2.4 DURATORQ 16V

CÓDIGO MOTOR: FMBA/B, HJBA, HJBB, HJBC, HJBE, N7BA, N7BB, SDBA, D5BA, D6BA, QJBA, QJBB, QJBC, ABFA, D3FA, F3FA, F1FA, D2FA, D4FA, D0FA, F4FA, FXFA, H9FA

~~230,00€~~ 139,00€

CONTEÚDO

- FG 192/F011-1 Ferramenta de desmontagem
- FG 192/F011-2 Pino de bloqueio do tensor da correia ø 1.9
- FG 192/F011-3 Ferramenta de alinhamento da bomba
- FG 192/F011-4 Cavilha de bloqueio do volante ø 14 ø 10
- FG 192/F011-5 Pino de bloqueio
- FG 192/F011-6 Ferramenta de bloqueio polie da árvore de cames
- FG 192/F011-7 Cavilha de bloqueio do volante ø 14

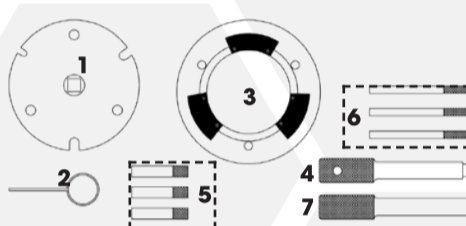

NEW FG 192/LR11



DISPOSITIVO DE AFINAÇÃO JAGUAR E LAND ROVER 2.0 INGENIUM DIESEL

MODELOS:

JAGUAR: E-Pace (X-540) D150/D180/D240; F-Pace (X761) 20d/25d/E-Performance, XE(X760) 20d/25d/E-Performance, XF(X260)

LAND ROVER: Discovery Sd4/Td4, Discovery Sport Td4/Sd4, Range Rover Evoque eD4/TD4/Sd4, Range Rover Evoque Convertible eD4/Td4/Sd4, Range Rover Velar D180/D240

MOTOR: 2.0 D

CÓDIGO MOTOR: 204DT, 204DTA, AJ-200D/204DT, AJ-200D, 204DTD

~~800,00€~~ 499,00€



FG 192/LR9



KIT DE AFINAÇÃO JAGUAR E LAND ROVER 3.2, 3.5, 4.0, 4.2, 4.4 V8

MODELOS:

JAGUAR: XJ8, XJ8 Sport, Sovereign, XJR V8, XKR, S-Type, XK8

LAND ROVER: Range Rover Supercharged, Discovery 3, Range Rover

DAIMLER: V8, Super V8

MOTOR: 3.2, 3.5, 4.0, 4.2

CÓDIGO MOTOR: AC, KB, KC, RB, BC, CC, CE, LB, LC, MA, MB, NB, NC, 1B, 2B, 3B, 1G, 5G, 9G, HB, HG, SB, TB, PC, 428PS, 448PN, BC, DC

~~350,00€~~ 205,00€



FG 192/LR8



KIT DE AFINAÇÃO JAGUAR E LAND ROVER 2.0 GTDI

MODELOS:

JAGUAR: XE, XJ, XF

LAND ROVER: Discovery Sport, Freelander 2

RANGE ROVER: Evoque

MOTOR: 2.0 GTDI

CÓDIGO MOTOR: 204PT

~~320,00€~~ 179,00€



FG 192/JE9



KIT DE AFINAÇÃO JEEP GRAND CHEROKEE 3.0 CRD MULTIJET (A PARTIR DE 2011)

MODELOS:

JEEP: Grand Cherokee

MOTOR: 3.0 CRD/Multijet

CÓDIGO MOTOR:

EXF VM23D; EXF VM44D; EXF

~~300,00€~~ 169,00€



FG 192/LR2



KIT DE AFINAÇÃO LAND ROVER TD5

MODELOS: LAND ROVER: Defender, Discovery II

MOTOR: 2.5 Diesel

CÓDIGO MOTOR: 10P, 15P, 16P

~~50,00€~~ 26,90€

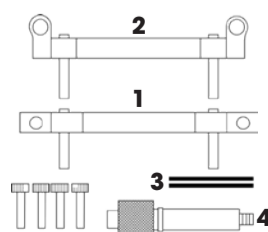

CONTEÚDO

- FG 192/JE9-1 Ferramenta de bloqueio da árvore de cames (DX)
- FG 192/JE9-2 Ferramenta de bloqueio da árvore de cames (SX)
- FG 192/JE9-3 Pinos de bloqueio do tensor
- FG 192/JE9-4 Pino de sincronização da cambota

# KIT DE AFINAÇÃO

FG 192/LR6



## CONJUNTO DE REMOÇÃO / INSTALAÇÃO DA POLIA DE ÁRVORE MOTOR JAGUAR & LAND ROVER V8

**MODELOS:** JAGUAR: XJ8; XJ8 Sport; Sovereign; XJR V8; XKR; S-Type; XK8

**LAND ROVER:** Range Rover Supercharged; Discovery 3; Range Rover

**MOTOR:** 3.2; 3.5; 4.0; 4.2

**CÓDIGO MOTOR:** AC, KB, KC, RB, BC, CC, CE, LB, LC, MA, MB, NB, NC, 1B, 2B, 3B, 1G, 5G, 9G, HB, HG, SB, TB, PC, 428PS, 448PN, BC, DC

260,00€ 149,00€

FG 192/CH3



## KIT DE AFINAÇÃO CHRYSLER, JEEP, DODGE DIESEL

**MODELOS:**

**CHRYSLER:** Grand Voyager, JEEP: Cherokee, Wrangler, DODGE: Nitro

**MOTOR:** 2.8 Diesel

**CÓDIGO MOTOR:** VM64C, ENS, ENS (51C), 49C, 50C, ENS VM10D

155,00€ 89,00€

FG 192/MI9



## KIT DE AFINAÇÃO MOTOR BMW MINI 1.6 DIESEL W16D

**MODELOS:** MINI: Clubman (Cooper D) (R55), Cooper D (R56/57), One D (R56/57)

**CITROEN:** Berlingo III, Berlingo/Berlingo First I/II, C2, C3 I/II/First/Classic, C3 Picasso, C4, C4 Picasso/Grand Picasso, C5 II, C5 III, Xsara Picasso, C4 Aircross, C4 II, DS3/DS3 Cabrio, DS4, DS5, Dispatch/Jumpy III

**PEUGEOT:** 1007, 206, 206 CC, 207, 207 CC, 3008, 307, 308, 308 CC, 407, 5008, Partner III, Partner, Partner Origin/Ranch I/II, Expert III

**MOTOR:**

1.6 D, 1.6 Hdi, 1.6 e-HDi Airdream, 1.6 e-HDi

**CÓDIGO MOTOR:** W16 D16 (9HZ), W16 D16UO

70,00€ 39,90€

FG 192/CH8



## KIT DE AFINAÇÃO JEEP E CHRYSLER 2.5 CRD / 2.8 CRD

**MODELOS:**

**JEEP:** Cherokee. LDV: Maxus

**CHRYSLER:** Grand Voyager, Voyager.

**MOTOR:** 2.5CRD, 2.8CRD

**CÓDIGO MOTOR:** R2516C, R2816C5.05A, R2516K, R2816K4, R2516L VM39/40B, R2516L7 VM57/58C

210,00€ 119,00€

FG 192/MI10



## KIT DE AFINAÇÃO MINI, PSA 1.4, 1.6 16V N12&N14

**MODELOS:**

**MINI:** Mini One, Mini Couper, Mini Couper S, Mini Clubman

**CITROEN:** C4, C4 Picasso

**PEUGEOT:** 207, 308

**MOTOR:** 1.4 (N12/N14), 1.6 THP

**CÓDIGO MOTOR:** R55, R56, EP3, EP6, EP6DT, DTS

325,00€ 199,00€

### CONTEÚDO

FG 192/CH8-1 Cavilha de bloqueio da árvore de cames - entrada

FG 192/CH8-2 Cavilha de bloqueio árvore de cames - escape

FG 192/CH8-3 Cavilha de bloqueio do volante (Voyager/Grand Voyager 2.5/2.8 and LVD Maxus)

FG 192/CH8-4 Cavilha de bloqueio do volante (Jeep Cherokee 2.8)

FG 192/CH8-5 Cavilha de bloqueio do volante

FG 192/VW1-D Chave tensora da correia

FG 192/CH8-7 Cavilha de bloqueio do veio do equilibrador

FG 192/CH8-8 Cavilha de bloqueio do volante (veio do equilibrador)

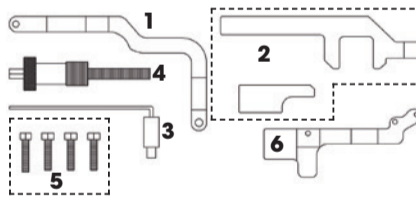
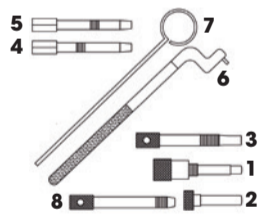

### CONTEÚDO

FG 192/MI10-1 Ferramenta de bloqueio da árvore de cames - entrada

FG 192/MI10-2 Ferramenta de bloqueio da árvore de cames - entrada (N14) + Grampo de bloqueio da árvore de cames

FG 192/MI10-3 Cavilha e sincronização da cambota

FG 192/MI10-4 Tensor da corrente de distribuição

FG 192/MI10-5 Parafusos de fixação

FG 192/MI10-6 Ferramenta de bloqueio da árvore de cames - escape

FG 192/MI6



## KIT DE AFINAÇÃO BMW MINI ONE, COOPER, COOPER S 1.6 BENZINA (R50/R52/R53)

**MODELOS:**

Mini Cooper 2001-09; Mini Cooper S 2002-2004; Mini One 2001-2009

**MOTOR:** 1.6 benzina

**CÓDIGO MOTOR:** W10B16BA; W11B16AA; W10B16AA

215,00€ 119,00€

FG 192/MI10B



## KIT DE AFINAÇÃO MINI, PSA 1.4, 1.6 VTI

**MODELOS:**

**MINI:** Clubman

**CITROEN:** C3 III; C4 II; DS3/DS3 Cabrio; Berlingo III; C3 Picasso; C4 Picasso/Grand Picasso II; C5 III (2010 - 2013); DS4

**PEUGEOT:** 308; 207; 208; 3008; 308; 308 CC; 5008; 508; Partner III

**MOTOR:** 1.4 VTI, 1.6 VTI

**CÓDIGO MOTOR:** 8FR (EP3C); 5FS (EP6C); 5FW (EP6); EP3C (8FR); EP6C (5FS); EP3 (8FS)

270,00€ 149,00€

### CONTEÚDO

FG 192/MI6-1 Ferramenta de fixação da árvore de cames

FG 192/MI6-2 Ferramenta de suporte do motor

FG 192/MI6-3 Alavanca de tensão da correia de distribuição

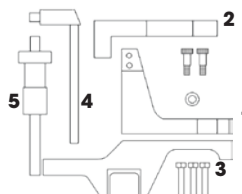
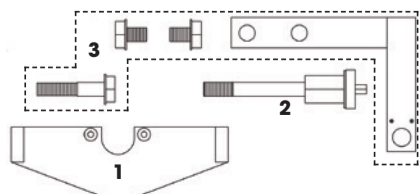

### CONTEÚDO:

FG 192/MI10B-1 Ferramenta de bloqueio da árvore de cames (entrada)

FG 192/MI10B-2 Ferramenta de bloqueio da árvore de cames (escape)

FG 192/MI10B-3 Parafusos de fixação

FG 192/MI10B-4 Ferramenta de travamento do volante

FG 192/MI10-4 Cavilha e sincronização da cambota



FG 192/MB3



**KIT DE AFINAÇÃO MERCEDES BENZ 1.8, 2.1 CDI DIESEL**

**MODELOS:**  
Classe-A, Classe-B, Classe-C, Classe-C Coupe, CLA, CLS, Classe E, Classe E, Coupe/Cabriolet, GLK, Classe-M, Classe-S, SLK, Sprinter, Viano, Vito

**MOTOR:** 1.8 CDI, 2.1 CDI  
**CÓDIGO MOTOR:** 651.901, 651.930, 651.913, 651.910, 651.911, 651.912, 651.924, 651.925, 651.922, 651.916, 651.960, 651.961, 651.980, 651.9, 651.956, 651.955, 651.957, 651.940

~~245,00€~~ **139,00€**

FG 192/MB3A



**EIXO DE BLOQUEIO PARA MERCEDES-BENZ 1.8 / 2.1 CDI DIESEL (M651) EIXO DE BALANCEAMENTO DO MOTOR**

~~215,00€~~ **125,00€**

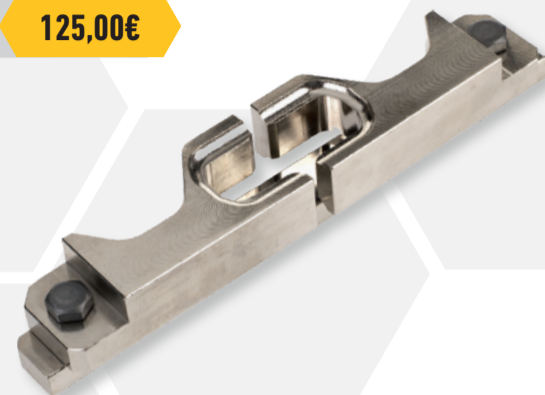

FG 192/MB10



**KIT DE AFINAÇÃO MERCEDES-BENZ M642**

**MODELOS:**  
Classe C; CLK; CLS; CLASSE E; CLASSE GL; GLK; CLASSE M; CLASSE R; CLASSE S; SPRINTER; VITO; VIANO

**MOTOR:** 3.0 Diesel  
**CÓDIGO MOTOR:**  
M642 (642,82; 642,822; 642,83; 642, 835;642,836; 642,838; 642,992;...)

~~160,00€~~ **89,90€**



FG 192/MB3C



**KIT DE AFINAÇÃO MERCEDES BENZ 1.8,2.1 CDI DIESEL -M651 DAL 2012**

**MODELOS:**  
Classe A, Classe B, Classe C, Classe E, CLS, Sprinter, Viano, Vito

**MOTOR:** 1.8 CDI, 2.1 CDI  
**CÓDIGO MOTOR:** M651 dal 2012 in poi

~~255,00€~~ **145,00€**

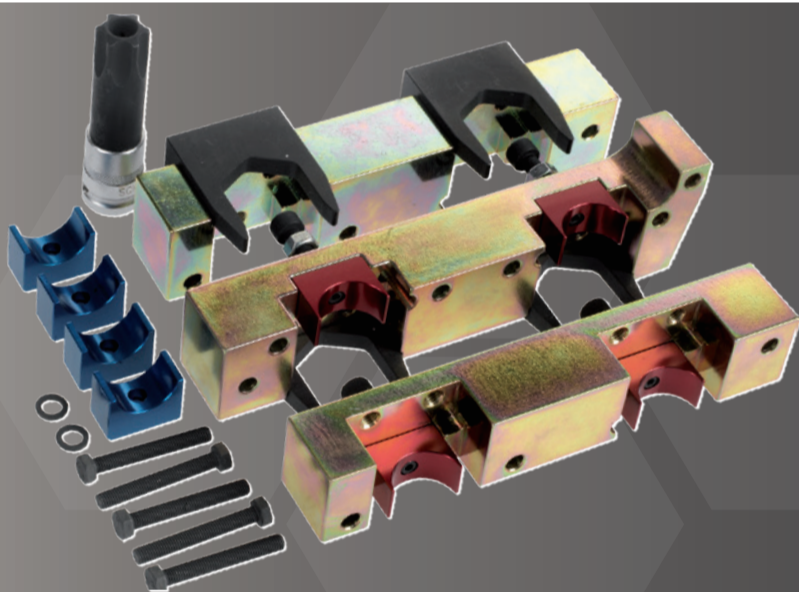

FG 192/MB24



**FERRAMENTAS DE APERTO DA ÁRVORE DE CAMES MERCEDES BENZ 1.6/2.0**

**MODELOS:**  
Classe A, Classe B, CLA, Classe C, Classe C Coupe, Classe E, GLK  
**MOTOR:** 1.6, 2.0 Benzina

**CÓDIGO MOTOR:** 270.910, 270.920, 133.980, 274.910, 274.920

~~900,00€~~ **549,00€**

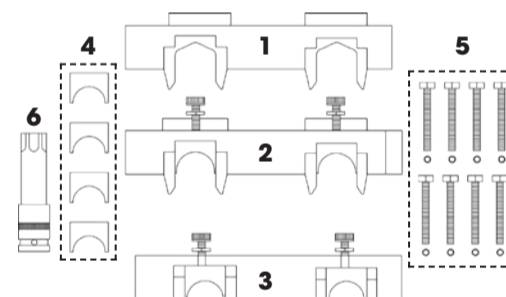

**CODICE**  
FG 192/MB24-1 Conjunto de aperto da árvore de cames (LADO DA CORRENTE) - (2009/2014)  
FG 192/MB24-2 Conjunto de aperto da árvore de cames (lado da corrente) - (2014 - )  
FG 192/MB24-3 Conjunto de aperto da árvore de cames (LADO DA CAIXA DE VELOCIDADES)  
FG 192/MB24-4 Blocos da árvore de cames de diâmetro pequeno  
FG 192/MB24-5 Parafusos de fixação  
FG 192/MB24-6 Ponta de aparafusar de segurança

FG 192/MB5



**KIT DE AFINAÇÃO MERCEDES-BENZ 1.8**

**MODELOS:**  
Classe-C; Classe C Coupe; Classe CLC; CLK; Classe E; SLK; Sprinter  
**MOTOR:** 1.8 Benzina  
**CÓDIGO MOTOR:** 271.820; 271.860; 271.861; 271.921; 271.940; 271.941; 271.942; 271.944; 271.946; 271.948; 271.950; 271.951; 271.952; 271.954; 271.955; 271.956; 271.957; 271.958

~~430,00€~~ **265,00€**



FG 192/MB6



**KIT DE AFINAÇÃO 2.1, 2.2, 2.7, 3.2 CDI/CRD MERCEDES-BENZ E CHRYSLER**

**MODELOS:**  
Mercedes-Benz: Classe-C; Classe-CLC; CLK; Classe-E; Viano; Vito; Sprinter; Classe-M; Classe-S Chrysler; PT Cruiser

**MOTOR:** 2.1 CDI; 2.2 CDI; 2.7 CDI; 3.2 CDI; 2.2 CRD  
**CÓDIGO MOTOR:** 611.960; 611.961; 611.962; 611.987; 611.980; 611.981; 612.961;612.962; 612.963; 612.965; 612.967; 613.960;613.961; 646.811; 646.812; 646.820; 646.821; 646.951; 646.961; 646.962; 646.963; 646.980; 646.981; 646.982; 646.984; 646.985; 646.986; 646.989; 646.990; 647.961; 648.961; 648.960; EDJ

~~175,00€~~ **89,90€**

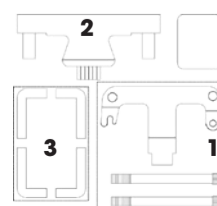

**CONTEÚDO**  
FG 192/MB6-1 Bloqueio da placa do volante Ferramenta com pernos M6 x 90 mm  
FG 192/MB6-2 Ferramenta de bloqueio da placa do volante  
FG 192/MB6-3 Cavilhas de bloqueio do tensor (x2)

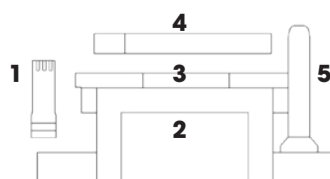

**CONTEÚDO**  
FG 192/MB5-1 Rebite estrela  
FG 192/MB5-2 Ponte de retenção da corrente da árvore de cames  
FG 192/MB5-3 Ferramenta de bloqueio da árvore de cames  
FG 192/MB5-4 Cunha da calha do tensor da corrente da árvore de cames  
FG 192/MB5-5 Mandril do tensor da corrente da árvore de cames

# KIT DE AFINAÇÃO



**FG 192/OP5**

## KIT DE AFINAÇÃO OPEL 1.0, 1.2, 1.4 A CADEIA

**MODELOS:**  
Corsa; Combo; Agila; Astra; Meriva; Tigra  
**MOTOR:** 1.0 12V; 1.0 16V; 1.2 16V; 1.4 16V  
**CÓDIGO MOTOR:** X10XE, Z10XE, Z10XEP, Z12XE, Z12XEP,  
Z14XEP, Z14XEL

~~100,80€~~ **59,90€**

**CONTEÚDO**  
FG 192/OP5-1 Ferramenta de localização do sensor do árvore de cames  
FG 192/OP5-2 Pino de 4 mm do tensor da corrente  
FG 192/OP5-3 Pino de 2,5 mm do tensor da correia  
FG 192/OP5-4 Pino de bloqueio da cambota  
FG 192/OP5-5 Placa de bloqueio da árvore de camese

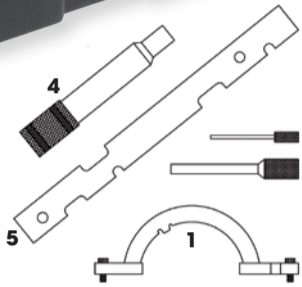

**FG 192/OP7B**

## KIT DE ATUALIZAÇÃO PARA FG 192/OP5

**ELE PERMITE O TEMPO TAMBÉM DOS MODELOS SEGUINTE:**  
Adam, Ampera, Astra-J, Insignia, Meriva-B, Mokka, Zafira-C Tourer, Astra-G, Astra-H,  
Barina, Meriva-A, Tigra-B  
**MOTORES ADICIONALES:** 1.0 ecoFLEX, 1.2 ecoFLEX, 1.4 ecoFLEX, 1.4 Turbo ecoFLEX  
**CÓDIGO MOTOR ADICIONALES:** LWD, L2Z, LDD, LUU/A14XFL, LDD/A14XEL, LDD/  
A14XER, LUJ/A14NEL, LUJ/A14NET, A10XEP, A12XEL, A12XER, A14XER, A14NEL, LUJ/  
A14NET, LUH/A14NEL, A14NET,

~~240,80€~~ **129,00€**



**FG 192/OP7**

## KIT DE AFINAÇÃO OPEL 1.0, 1.2, 1.4 A CADEIA ED ECOFLEX

**MODELOS:**  
Adam, Agila, Ampera, Astra-J, Corsa-D, Insignia, Meriva-B, Mokka,  
Zafira-C Tourer, Corsa-B, Corsa-C, Astra-G, Astra-H, Combo, Combo-C,  
Barina, Meriva-A, Tigra-B  
**MOTOR:**  
1.0, 1.0 ecoFLEX, 1.2, 1.2 ecoFLEX, 1.4, 1.4 ecoFLEX, 1.4 Turbo ecoFLEX  
**CÓDIGO MOTOR:** LWD, L2Z, LDD, LUU/A14XFL, LDD/A14XEL, LDD/A14XER,  
LUJ/A14NEL, LUJ/A14NET, A10XEP, A12XEL, A12XER, A14XER, A14NEL,  
LUJ/A14NET, LUH/A14NEL, A14NET

~~290,80€~~ **169,00€**

**FG 192/OP2**

## KIT DE AFINAÇÃO OPEL 1.4-2.2 16V ECOTEC

**MODELOS:** Astra F, G e H; Corsa B e C; Combo; Tigra;  
Vectra B e C; Zafira A e B; Meriva; Signum; Calibra; Omega  
B; Frontera A e B  
**MOTOR:** 1.4 16V; 1.6 16V; 1.8 16V;  
2.0 16V; 2.2 16V  
**CÓDIGO MOTOR:** 1.4 16V: X14XE, Z14XE, X16SEJ, X16XE,  
X16XEL, Y16XE, Z16XE, Z16YNG 1.8 16V: C18XEL, X18E1,  
X18XE, X18XE1, Z18XE, Z18XEL 2.0 16V: C20SEL, X20XEV,  
Z20LEH; Z20LEL; Z20LER; Z20LET 2.2 16V: X22SE,  
X22XE, Y22SE, Y22XE, Z22X

~~50,00€~~ **26,90€**

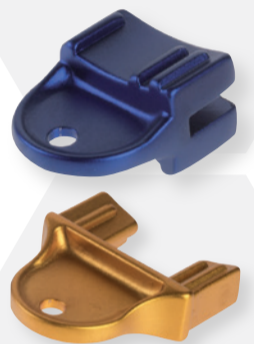

**FG 192/OP3A**

## KIT DE AFINAÇÃO OPEL 1.0, 1.4 B10/B14

**MODELOS:** Adam; Adam Rocks; Astra-K;  
Corsa-E; Mokka X  
**MOTOR:** 1.0; 1.0 Turbo SIDI; 1.0 Turbo SIDI  
ecoFLEX; 1.4; 1.4 Turbo  
**CÓDIGO MOTOR:** LE1/B10XFL; LE1/B10XFT; LE1/  
B10XHL; LV7/B14XE; LE2/B14XFL; LE2/B14XFT

~~115,80€~~ **69,00€**

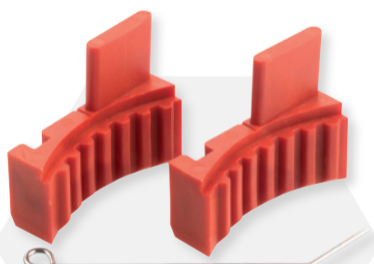

**FG 192/OP3**

## KIT DE BLOQUEIO POLIAS OPEL 1.6 16

**MODELOS:** Astra G e H; Astra H Turbo; Corsa D  
**MOTOR:** 1.6 16V  
**CÓDIGO MOTOR:** Z16XE1, Z16XER,  
Z16XEP, Z16LET, Z16LER

~~50,00€~~ **26,90€**



**FG 192/OP1**

## FERRAMENTAS DE BLOQUEIO VOLANTE 1.3 CDTI

~~15,00€~~ **7,90€**



**FG 192/OP4**

## KIT DE AFINAÇÃO OPEL 1.3 CDTI

**MODELOS:** Astra, Corsa, Agila, Combo, Meriva  
**MOTOR:** 1.3 CDTI  
**CÓDIGO MOTOR:** Z13DT, Z13 DTH, Z13 DTJ

~~90,00€~~ **49,90€**

**FG 192/OP3B**

## FERRAMENTA DE TRAVAMENTO DE POLIA DA CAMBOTA PARA MOTORES OPEL 1.0/1.4 B10/B14

**MODELOS:** Astra-K; Karl; Karl Rocks; Mokka X; Viva  
**MOTOR:** 1.4; 1.4 Turbo; 1.0; 1.0 ecoFLEX; 1.0 LPG ecoFLEX; 1.0 LPG ecoFLEX  
**CÓDIGO MOTOR:** LV7/B14XE; LE2/B14XFL; LE2/B14XFT; L5Q/B10XE; LWT/B10XL

~~255,80€~~  
**159,00€**



**NEW FG 192/OP4D**

## KIT DE AFINAÇÃO OPEL 1.3 CDTI

**MODELOS:** Corsa-E  
**MOTOR:** 1.3 CDTI  
**CÓDIGO MOTOR:** LKU/B13DTE; LKV/B13DTC; LKU/B13DTR

~~550,80€~~ **349,00€**



**FG 192/OP4B**

**KIT DE AFINAÇÃO OPEL 1.6 CDTI E 1.6 SIDI TURBO (A PARTIR DE 2013)**

**MODELOS:**  
Astra-J, Astra-K, Insignia; GTC, Meriva-B, Mokka, Zafira-C Tourer, Cascada

**MOTOR:** 1,6 CDTI; 1.6CDTI ecoFLEX; 1.6SIDI Turbo; 1.6SIDI Turbo ecoFLEX

**CÓDIGO MOTOR:**  
LVL/B16DTH; LVL/B16DTJ; LVL/B16DTN; LVM/B16DTL; LVM/B16DTC; LWQ/B16DTC; LWQ/B16DTE; LVK/ B16DTR; LWV/ B16DTU; LWC/A16SHT; LWC/B16SHL; LWC/B16SHT; LVP/ A16XHT

~~350,00€~~ **199,00€**

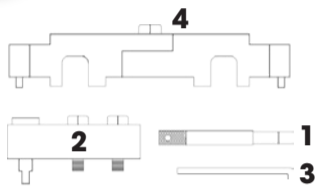

**CONTEÚDO**  
FG 192/OP4B-1 Pino de fixação do alinhamento árvore de cames  
FG 192/OP4B-2 Ferramenta de alinhamento da cambota  
FG 192/OP4B-3 Pino de bloqueio do tensor  
FG 192/OP4B-4 Ferramenta de fixação do carreto árvore de cames



**FG 192/OP6**

**KIT DE AFINAÇÃO OPEL 2.0 CDTI, CHEVROLET 2.0D VCDI**

**MODELOS:**  
Antara, Captiva, Epica, Nubira, Lacetti, Evada

**MOTOR:** 2.0 CDTI

**CÓDIGO MOTOR:**  
Z20DMH, Z20DM, Z20S1, RA420

~~100,00€~~ **59,90€**

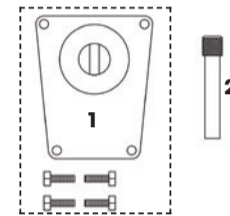

**CONTEÚDO**  
FG 192/OP6-1 Ferramenta de bloqueio da árvore de cames  
FG 192/OP6-2 Cavilha de bloqueio da cambota



**FG 192/OP8**

**KIT DE AFINAÇÃO OPEL 2.0, 2.2**

**MODELOS:**  
**OPEL:** Omega-B, Vectra-B, Astra-G, Zafira-A, Signum, Frontera-B  
**SAAB:** 9-3, 9-5

**MOTOR:** 2.0 DTi, 2.2 DTi, 2.2 TiD  
**CÓDIGO MOTOR:** X20DTH, X20DTL, Y20DTH, X22DTH, Y22DTR, D223L

~~165,00€~~ **99,00€**

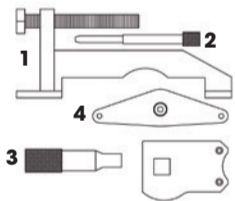

**CONTEÚDO**  
FG 192/OP8-1 Ferramenta de bloqueio da polia da árvore de cames  
FG 192/OP8-2 Ferramenta de bloqueio da bomba de injeção  
FG 192/OP8-3 Cavilha de bloqueio da cambota  
FG 192/OP8-4 Ferramenta de bloqueio da árvore de cames



**FG 192/OP15**

**KIT DE AFINAÇÃO OPEL 2.0 CDTI**

**MODELOS:**  
**OPEL:** Cascada; Insignia-A Country Tourer; Insignia-A; Zafira-C Tourer

**MOTOR:** 2.0 CDTi, 2.0 CDTiEcoflex  
**CÓDIGO MOTOR:** LFS/B20DTH

~~575,00€~~ **339,00€**



**FG 192/OP9**

**KIT DE AFINAÇÃO OPEL, SAAB, CHEVROLET 2.0 E 2.4 TURBO**

**MODELOS:**  
**OPEL:** Astra; Astra-J; Insignia; Antara  
Saab: 9-5  
**CHEVROLET:** Captiva; HHR; Malibu

**MOTOR:** 2.0 e 2.4 D (OPC; OPC/VXR); Turbo; Turbo ecoFLEX  
**CÓDIGO MOTOR:** LHU/A20NFT; LKD/A20NHT; A24XE; A24XF; LE5; LE9

~~380,00€~~ **229,00€**

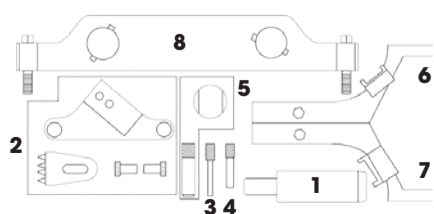

**CONTEÚDO**  
FG 192/OP9-1 Ferramenta de alinhamento da polia da cambota  
FG 192/OP9-2 Ferramenta de fixação do volante + base  
FG 192/OP9-3 Pino de retenção do tensor de 2,5 mm  
FG 192/OP9-4 Pino de retenção do tensor de 4,0 mm  
FG 192/OP9-5 Ferramenta de redefinição do êmbolo do tensor  
FG 192/OP9-6 Ferramenta de bloqueio árvore de cames, lado esquerdo  
FG 192/OP9-7 Ferramenta de bloqueio da árvore de cames, lado direito  
FG 192/OP9-8 Ferramenta de fixação do regulador da árvore de cames



**FG 192/OP10**

**KIT DE AFINAÇÃO OPEL, SAAB 2.0 TURBO**

**MODELOS:**  
**OPEL:** Signum, Vectra-C  
**SAAB:** 9-3

**MOTOR:** 2.0, 2.0 Turbo  
**CÓDIGO MOTOR:** Z20NET; B207E; B207L

~~225,00€~~ **129,00€**

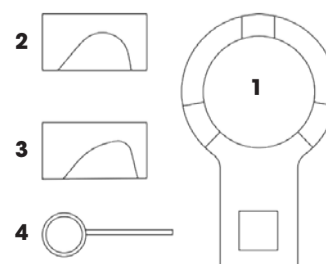

**CONTEÚDO**  
FG 192/OP10-1 Ferramenta de fixação da cambota  
FG 192/OP10-2 Ferramenta alinhamento da árvore de cames de admissão  
FG 192/OP10-3 Ferramenta alinhamento da árvore de cames de escape  
FG 192/FT3-2 Pino de tensão de 1,0mm

# KIT DE AFINAÇÃO



FG 192/PS13



## KIT DE AFINAÇÃO PSA 1.4 E 1.6HDI

### MODELOS:

**PEUGEOT:** 107, 206, 206 Cc 207, 307, 307 Cc, 308, 406, 406 Coupe, 407, 607, 806, Expert I/II, Expert III, 807

**CITROEN:** Xsara Picasso, Xsara II, C1, C3, C3 Pluriel, C4, C4 Picasso, Grand Picasso, Berlingo/Berlingo First I/II, C5 I, C5 II, C8, Dispatch/Jumpy III, Synergie/Evasion

**MOTOR:** 1.4D Hdi, 1.6D Hdi, 1.8, 1.8 16V, 2.0, 2.0 16V, 2.0 Hpi, 2.0 Gti 180/RC, 2.2

**CÓDIGO MOTOR:** EW10A(RFJ), EW10D(RLZ), EW10J4(RFR), W10J4L5(RFN), EW10J4S(RFK), EW12J4(3FY/3FZ), W12J4/5(3FZ), EW7A(6FY), EW7J4(6FZ), 9HY/9HZ(DV6TED4), 9HX(DV6ATED4), 9HW(DV6BTED4), 9HU(DV6UTED4), DV4TD (8HT/8HX/8HW/8HV/8HY/8HZ)

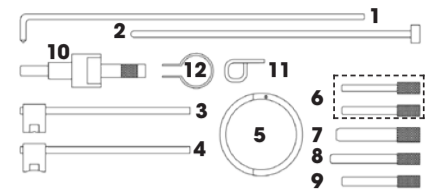

- FG 192/PS13-1 Pino de tensão
- FG 192/PS13-2 Chave tensora da correia
- FG 192/PS15-6 Pino de tensão
- FG 192/PS15-5 Pino de tensão
- FG 192/PS13-5 Pino de tensão
- FG 192/PS13-6 Cavilhas de sincronização
- FG 192/F024-22 Cavilhas de sincronização
- FG 192/PS15-7 Cavilhas de sincronização
- FG 192/F024-23 Cavilhas de sincronização
- FG 192/PS13-10 Chave tensora da correia
- FG 192/PS13-11 Pino de tensão
- FG 192/PS13-12 Pino de tensão

~~195,00€~~ 105,00€



FG 192/PS15



## KIT DE AFINAÇÃO PSA 1.9D, 2.0D HDI, 2.2D HDI

### MODELOS:

Xsara; 307; 406; 607; 806; Expert I/II; 807; 206; 306; Boxer; 406 Coupe

**MOTOR:** 1.9D, 2.0D HDI, 2.2D HDI

**CÓDIGO MOTOR:** DW8/L3(WJZ), DW10TD(RHY), W10ATED(RHS), W10ATED(RHZ), DW10ATED4/L4(RHT), DW10BTED(RHX), W10JATED4(RHW), DW10D(RHY), DW10UTD(RHV), W12ATED(4HX), DW12ATED(4HZ), DW12UTED(4HY), DW8(WJY), DW8/L/W3(WJZ), DW8B/L4(WJY)



FG 192/PS7



## KIT DE AFINAÇÃO PSA, LAND ROVER, JAGUAR

**PEUGEOT:** 407, 607

**CITROEN:** C5 III, C6

**LAND ROVER:** Discovery 3, Discovery 4, Range Rover Sport.

**JAGUAR:** S-Type, XF, XJ6 .

**MOTOR:** 2.7, 2.7 TDV6, 2.7 TDV1, 2.7HDI

**CÓDIGO MOTOR:** 276DT, 276DT (7B/7G), 7G, UHZ (DT17BTED4), DT17TED4 (UHZ)

~~225,00€~~ 99,00€

~~195,00€~~ 99,00€

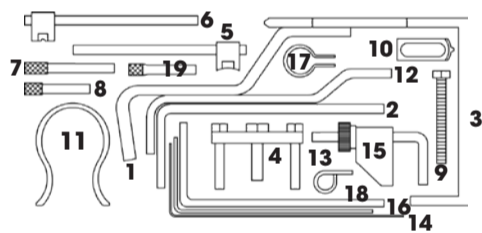

- FG 192/PS15-1 Ferramenta de bloqueio do volante
- FG 192/PS15-2 Ferramenta de bloqueio do volante
- FG 192/PS13-11 Pino de sincronização do volante- 8mm
- FG 192/PS15-4 Extrator de polia da cambota
- FG 192/PS15-5 Ferramenta de tensão
- FG 192/PS15-6 Ferramenta de tensão
- FG 192/PS15-7 Ferramenta de bloqueio do volante - 8mm
- FG 192/PS15-8 Ferramenta de bloqueio do volante - 6mm
- FG 192/PS15-9 M8x80mm
- FG 192/PS15-10 Ferramenta de bloqueio do volante
- FG 192/PS15-11 Timingbeltretainingclip
- FG 192/PS15-12 Clipe correia dentada
- FG 192/PS15-13 Ferramenta de centralização da roda dentada da cambota
- FG 192/PS15-14 Pin de bloqueio do tenção
- FG 192/PS15-15 Ferramenta de bloqueio correia dentada
- FG 192/PS15-16 Ferramenta da polia tensora de tela auxiliar
- FG 192/PS15-17 Crankshaft sprocket centralizing tool
- FG 192/PS15-18 Pino de sincronização do volante
- FG 192/PS15-19 Pin de bloqueio da árvore de cames

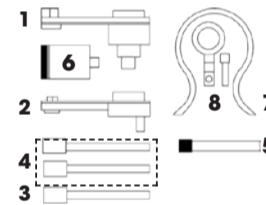

### CONTEÚDO

- FG 192/PS7-1 Cavilha de sincronização do volante (transmissão automática)
- FG 192/PS7-2 Cavilha de sincronização do volante (Transmissão Manual)
- FG 192/PS7-3 Ferramenta de retenção da polieda árvore de cames
- FG 192/PS7-4 Herramienta de alineación del piñón de árbol de levas
- FG 192/PS7-5 Ferramenta de bloqueio
- FG 192/PS7-6 Cavilha de bloqueio do volante
- FG 192/PS15-11 Clip
- FG 192/PS7-8 Ferramentas para a bomba de combustível

FG 192/PS4



## KIT DE AFINAÇÃO PSA/FIAT 2.5D, 2.8

### MODELOS:

**PEUGEOT:** Relay/Jumper

**CITROEN:** Boxer, Boxer II

**FIAT:** Ducato, Croma, Talento

**MOTOR:** 2.8, 2.8 TDi, 2.8 HDI

**CÓDIGO MOTOR:** 8140,63, 8140.43S, 8140.43N, 8144,67,27, 8140.47R, 8144,21, 8140,47



FG 192/PS2



## KIT DE AFINAÇÃO PSA 1.0VTI, 1.2VTI

### MODELOS:

**PEUGEOT:** 208, 308, 2008

**CITROEN:** C3 III, DS3/DS3 Cabrio

**MOTOR:** 1.0 VTI, 1.2 VTI

**CÓDIGO MOTOR:** EBO(ZMZ), EB2(HMZ), ZMZ(EBO)

~~50,00€~~ 29,90€

~~185,00€~~ 99,00€

FG 192/PS7B



## KIT DE AFINAÇÃO CITROËN/PEUGEOT 1.4 16V

### MODELOS:

**CITROEN:** Berlingo/Berlingo First I/II; C2

**PEUGEOT:** 1007; 206; 207; 307

**MOTOR:** 1.4 benzina a cinghia

**CÓDIGO MOTOR:** KFW(TU3A); KFW(TU3JP/L4); KFW(TU3A); KFW(TU3JP); ET3J4(KFU); ET3JP4(KFU); TU3A(KFV)

FG 192/PSA



## FERRAMENTA PARA INSTALAÇÃO DO CINTO ELÁSTICO DA BOMBA DE ÁGUA DOS MOTORES PSA E OPEL 1.0 / 1.2 DE 3 CILINDROS A PARTIR DE 2012

### MODELOS:

**PEUGEOT:** 108, 208, 301, 308, 408, 2008, 3008, 5008, Partner

**OPEL:** Crossland X

**CITROEN:** C1, C3, C3 Picasso, C3 Aircross, C4, C4 Picasso, C4 Cactus, Berlingo, DS3, DS4, DS4S, DS5LS

**MOTOR:** 1.0, 1.2 benzina 3 cilindri

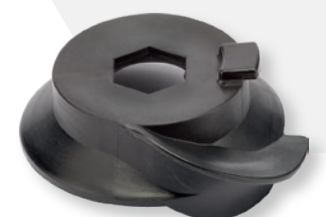

~~65,00€~~ 29,90€

~~32,00€~~ 19,90€



FG 192/RE5

**KIT DE AFINAÇÃO RENAULT & NISSAN**  
1.5 DCI, 1.4, 1.6 16V,  
1.8 16V, 2.0 16V, 1.4,  
1.6 16V, 1.8 16V, 2.0 16V

**MODELOS:**  
Clio, Megane, Megan Scenic, Laguna,  
Espace, Grand Espace, Kubistar, Primastar  
**MOTOR:** 1.5 dCi, 1.4, 1.6 16V, 1.8 16V, 2.0 16V  
**CÓDIGO MOTOR:**  
K4J, K4M, F4P, F4R, K9K, K4M

165,00€ 89,00€



FG 192/RE3

**KIT DE AFINAÇÃO RENAULT**  
1.5DCI, 1.4 & 1.6 16V

**MODELOS:** Clio, Kangoo, Megane, Scenic,  
Grand Scenic II, Clio III  
**MOTOR:** 1.5dCi, 1.4 & 1.6 16V  
**CÓDIGO MOTOR:** 1.5 dCi: K9K dal 2001; 1.4&1.6 16V: K4M,708,  
716, 730, 732, 750, 752, 753, 760, 761,  
766, 782, 800, 801, 812, 813

105,00€ 55,00€

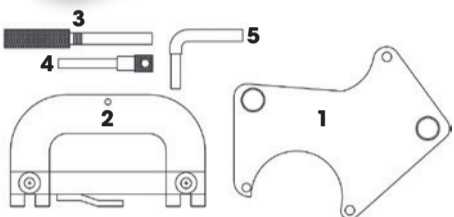

**CONTEÚDO**  
FG 192/RE3-1 Ferramenta de bloqueio polie do árvore de cames  
FG 192/RE5-2 Ferramenta de fixação da árvore de cames  
FG 192/RE3-3 Cavilha de bloqueio da cambota (1.4/1.6)  
FG 192/RE3-2 Cavilha de sincronização do ponto morto superior  
FG 192/RE5-5 Cavilha de bloqueio da cambota (1.8/2.0)

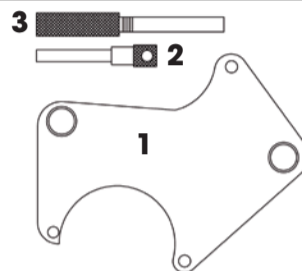

**CONTEÚDO**  
FG 192/RE3-1 Ferramenta bloqueio polie árvore de cames  
FG 192/RE3-2 Cavilhas sincronização da árvore de cames  
FG 192/RE3-3 Cavilhas de sincronização do cambota



FG 192/RE4

**KIT DE AFINAÇÃO RENAULT, NISSAN 1.6 DCI**

**MODELOS:**  
**NISSAN:** Qashqai; Qashqai+2; X-Trail  
**RENAULT:** Espace; Fluence; Megane III;  
Scenic/Grand Scenic III; Trafic III  
**MOTOR:** 1.6dCi  
**CÓDIGO MOTOR:** 1.5 dCi: K9K dal 2001;  
R9M; R9M 410; R9M 409; R9M 452; R9M 402;  
R9M 404; R9M 408; R9M 413; R9M 450; R9M 452

245,00€ 129,00€



FG 192/RE6

**KIT DE AFINAÇÃO RENAULT, OPEL, NISSAN 2.0D DCI**

**MODELOS:**  
**RENAULT:** Scenic, Grand Scenic II, Megane II, Laguna,  
Espace, Grand Espace, Trafic, Koleos  
**NISSAN:** Qashqai, Primastar  
**OPEL:** Vauxhall: Vivaro  
**MOTOR:** 2.0D dCi  
**CÓDIGO MOTOR:**  
**RENAULT:** M9R 700, 721, 724, 740, 752, 760, 761, 780,  
805, 830, 832, 833  
**NISSAN:** M9R, M9R780  
**OPEL, VAUXHALL:** M9R780, 750, 752, 753, 760, 761, 766,  
782, 800, 801, 812, 813

225,00€ 129,00€

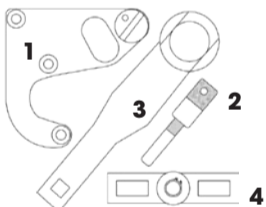

**CONTEÚDO**  
FG 192/RE4-1 Ferramenta de alinhamento da árvore de cames  
FG 192/RE4-2 Cavilha de bloqueio da cambota  
FG 192/RE6-5 Ferramenta de retenção da polia da cambota  
FG 192/RE6-6 Ferramenta de alinhamento da engrenagem da árvore de cames

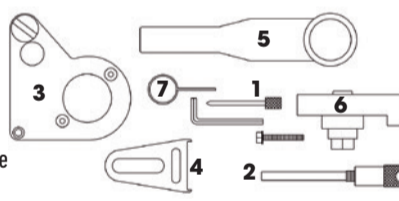

**CONTEÚDO**  
FG 192/FT6B-4 Cavilha de bloqueio do tensor da correia auxiliar (3,6mm)  
FG 192/RE6-2 Cavilha de bloqueio da cambota  
FG 192/RE6-3 Ferramenta de fixação da árvore de cames  
FG 192/RE6-4 Ferramenta de bloqueio do volante  
FG 192/RE6-5 Ferramenta de retenção da polia da cambota  
FG 192/RE6-6 Ferramenta de alinhamento da engrenagem do árvore de cames  
FG 192/RE6-7 Herramienta de bloqueio polea del árbol motor

FG 192/RE13

**KIT DE AFINAÇÃO OPEL, RENAULT, NISSAN 1.5, 1.9, 2.2, 2.5 DCI**

**MODELOS:**  
Clio, Kangoo, Megane, Scenic, Grand Scenic, Modus, Logan, Almera,  
Micra, Qashqai, Kubistar, Laguna, Trafic II, Movano, Vivaro, Primera,  
Interstar, Primastar, Espace, Grand Espace  
**MOTOR:** 1.5, 1.9, 2.2, 2.5 dCi  
**CÓDIGO MOTOR:** 1.5 dCi: K9K, 1.9 dCi: F9Q, 2.2 dCi: G9T, 2.5 dCi: G9U,  
750, 752, 753, 760, 761, 766, 782, 800, 801, 812, 813

285,00€ 155,00€



**CONTEÚDO**  
FG 192/RE13-1 Ferramenta de Travagem do Eixo de Transmissão Esvazie  
FG 192/RE13-2 Ferramenta de Travagem do Eixo de Transmissão injeção  
FG 192/RE13-3 Ferramenta de Tensão (1,9 DCI)  
FG 192/RE3-2 Pino de Travagem do Eixo de Manivela  
FG 192/RE13-5 Ferramenta de bloqueio da polie da Bomba de Injeção  
FG 192/RE13-6 Ferramenta de travagem do eixo de manivela  
FG 192/RE13-7 Pino de Travagem do Eixo de Manivela  
FG 192/RE13-8 Pino de Travagem da polie da Bomba de Injeção

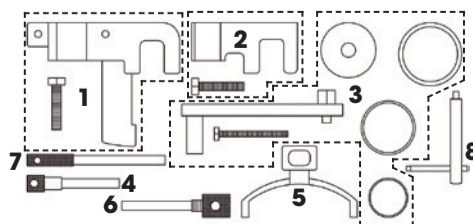

FG 192/RE13A

**EXTRATOR DE ENGRENAGEM DA BOMBA DE INJEÇÃO RENAULT, OPEL, NISSAN**

**MODELOS:**  
**NISSAN:** Interstar  
**RENAULT:** Espace/Grand Espace IV;  
Laguna II; Master II; Trafic II; Vel Satis  
**OPEL:** Movano-A; Vivaro  
**MOTOR:** 2.2 dCi/DTI; 2.5 dCi/DTI/CDTi  
**CÓDIGO MOTOR:** G9U...; G9T...

145,00€ 92,50€



FG 192/RE7

**DISPOSITIVO DE BLOQUEIO PINHÃO DE CABBOTA ÁRVOE DE CAMES RENAULT 1.8 E 2.0 16V**

**MODELOS:** Clio III; Laguna III Turbo/GT Turbo;  
Megane II; Megane III; Laguna; Megane; Scenic  
**MOTOR:** 1.8 e 2.0 16V benzina  
**CÓDIGO MOTOR:** F4R 830; F4R 832; F4Rt 800;  
F4Rt 802; F4Rt 820; F4Rt 810; F4Rt 811;  
F4Rt 813; F4Rt 774; F4Rt 776; F4Rt 872;  
F4Rt 874; F4Rt 870; F4Rt 874; F4P 760; F4P 720;  
F4P 722

95,00€ 52,50€



# KIT DE AFINAÇÃO

FG 192/VW1B



CHAVE DE LUNETA PARA PORCAS  
VW, AUDI, SEAT, SKODA

~~30,00€~~ 17,90€

FG 192/VW1C



CHAVE DE LUNETA PARA PORCAS  
VW, AUDI, SEAT, SKODA

~~30,00€~~ 17,90€

FG 192/VW1D



CHAVE DE LUNETA PARA PORCAS  
VW, AUDI, SEAT, SKODA

~~32,00€~~ 18,90€

FG 192/VW1E



CHAVE DE LUNETA PARA PORCAS  
VW, AUDI, SEAT, SKODA

~~47,00€~~ 28,90€

FG 192/VW1F



CHAVE DE LUNETA PARA PORCAS  
VW, AUDI, SEAT, SKODA

~~80,00€~~ 47,90€

FG 192/VW1



CHAVE DE LUNETA PARA PORCAS  
VW, AUDI, SEAT, SKODA

MODELOS:

**VOLKSWAGEN:** Polo, Lupo, Bora, Golf, Beetle  
Golf Estate, Caddy, Caddy Maxi, Polo Classic,  
**SKODA:** Fabia, Octavia, Octavia Tour, Octavia II  
**SEAT:** Cordoba, Ibiza, Arosatoledo, Leon, Inca  
**AUDI:** A2

**MOTOR:** 1.4 16V e 1.6 16V

**CÓDIGO MOTOR:** AFH, AFK, AHW, AJV, AKQ, APE,  
AQQ, ATN, AUA, AUB, AUS, AXP, AZD, BAD, BBY,  
BBZ, BCA, BCB, BKY.

~~50,00€~~ 26,90€

FG 192/VW5B



KIT DE AFINAÇÃO  
AUDI 3.0 V6 CADEIA

MODELOS:

**AUDI:** A4, A4 Cabrio,  
A4 quattro, A6, A8

**MOTOR:** 3.0 Benzina

**CÓDIGO MOTOR:** ASN, BBJ

~~280,00€~~ 169,00€

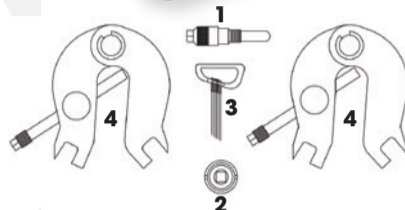

CONTEÚDO

FG 192/VW5B-1 Pasador de bloqueio del cigüeñal  
FG 192/VW5B-2 Ferramenta de bloqueio da polie árvore de cames  
FG 192/VW5B-3 Pino de bloqueio do tensor  
FG 192/VW5B-4 Ferramenta de fixação da árvore de cames (2)

FG 192/VW4B



KIT DE AFINAÇÃO  
VAG 1.0 3 CILINDROS

MODELOS:

**SEAT:** Mii

**SKODA:** Citigo, Fabia

**VOLKSWAGEN:** Up, Polo

**MOTOR:** 1.0 Benzina

**CÓDIGO MOTOR:** CHYA, CHYB, CPGA

~~250,00€~~ 139,00€

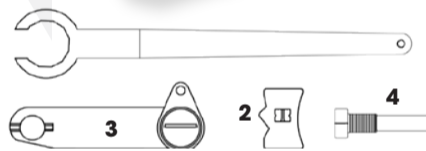

CONTEÚDO

FG 192/VW4B-1 Ferramenta de bloqueio da polia do tensor  
FG 192/VW4B-2 Ferramenta de bloqueio da árvore de cames  
FG 192/VW4B-3 Ferramenta de sincronização da árvore de cames  
FG 192/VW4B-4 Ferramenta de bloqueio da cambot

FG 192/VW4



KIT DE AFINAÇÃO  
VAG 1.2 3 CILINDROS 6V E 12V

MODELOS:

**VOLKSWAGEN:** Polo, Fox

**SEAT:** Cordoba, Ibiza

**SKODA:** Fabia, Roomster

**SEAT:** Cordoba, Ibiza

**MOTOR:** 1.2 3 CIL. 6V e 12V

**CÓDIGO MOTOR:** AWY, BMD, AZQ, BME

~~125,00€~~ 62,50€

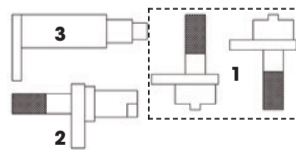

CONTEÚDO

FG 192/VW4-1 Placa de travagem (2) 12V  
FG 192/VW4-2 Placa de travagem 6V  
FG 192/VW4-3 Ferramenta de travagem do eixo de manivela

FG 192/VW2



KIT DE AFINAÇÃO  
VOLKSWAGEN, AUDI, SKODA 1.2 TSI

MODELOS:

**VOLKSWAGEN:** Beetle/Maggiolino, Caddy/Caddy Maxi,  
Golf Plus, Golf VI, Golf VI Cabrio, Golf VI Estate, Jetta, Polo, Touran

**AUDI:** A1, A2, A3 Cabrio

**SEAT:** Altea/Altea XL, Ibiza, Leon

**SKODA:** Fabia II, Octavia, Praktik, Roomster, Yeti

**MOTOR:** 1.2 TSI BENZINA

**CÓDIGO MOTOR:** CBZA, CBZB, CBZC

~~60,00€~~ 29,90€





**NEW** FG 192/VW3B

**KIT DE AFINAÇÃO VW, AUDI, SKODA-SEAT 1.4 FSI & 1.6 FSI**

**MODELOS:**  
**Volkswagen:** Polo; Golf V; Touran; Golf Plus; Eos; Golf Plus; Jetta; Passat; Beetle; Tiguan; Golf VI; Scirocco; Passat; Sharan  
**Audi:** A1; A3  
**Seat:** Ibiza; Toledo; Leon; Althea; Alhambra; Cordoba  
**Skoda:** Fabia II; Roomster; Rapid; Rapid Spaceback; Yeti; Octavia II; Superb II

**MOTOR:** 1.4 FSI, 1.6 FSI, 1.4 TSI, 1.6 16V  
**CÓDIGO MOTOR:** AUX; BKG; BLN; BAG; BLF; BLP; CAVD; CAVA; CAVB; CAVC; CAVE; CTHD; CAXA; CAVA; CAVD; BMY; CDGA; CKMA; CTHA; CTHB; CTHC; BTS; CTHE; CNKA; CFNA

~~240,00€~~ **149,00€**



FG 192/VW4C

**KIT DE SINCRONIZACIÓN VAG 1.2/1.4 TSI E TFSI**

**MODELOS:**  
 A3, A3 Sportback, A3 Saloon, A3 Cabrio, A3 Sedan, A1, A1 Sportback, Q3, Leon, Leon ST, Ibiza, Fabia III, Fabia III Estate, Octavia III, Polo, Jetta, Golf VII, Golf VII Estate, Golf VII Wagon, Passat, Golf SV  
**MOTOR:** 1.2TSI, 1.2TFSI, 1.4TSI, 1.4TFSI, 1.4 TSI ACT, 1.4GTE, 1.4 GTE Hybrid, 1.4TFSI COD, 1.4TGI BlueMotion, 1.4g-tron, 1.4e-tron  
**CÓDIGO MOTOR:** CJZA, CJZB, CJZC, CJZD, CYVD, CYVA, CYVB, CZCA, CXSA, CXSB, CPWA, CHPB, CUKB, CZDA, CPTA, CZIA

~~290,00€~~ **149,00€**



FG 192/VW8

**KIT DE AFINAÇÃO VAG 1.8/2.0 TFSI 4V (CADEIA)**

**MODELOS:**  
**VW:** Tiguan; CC; Golf VI; Passat; Beetle/Maggiolino; Eos; Scirocco  
**AUDI:** A4; A4 quattro; A5 Coupe e Cabriolet; A5 Sportback; Q5; TT  
**SKODA:** Octavia II; Superb; Yeti  
**MOTOR:** 1.8 TFSI; 2.0 TFSI  
**CÓDIGO MOTOR:** CCZA; CCZB; CCZC; CCZD; CDAA; CDAB; CDHB; CDNC; CFKA; CDNB; CETA; CJEB; CESA; CDHA

~~305,00€~~ **169,00€**



FG 192/VW8B

**FERRAMENTA DE BLOQUEIO DA POLIA DA CAMBOTA VAG 1.8/2.0 TFSI 4V (CADEIA)**

Kir associado FG 192/VW8

~~110,00€~~ **59,90€**



FG 192/VW8D

**FERRAMENTA DE INSTALAÇÃO NEW DE VEDAÇÃO DO VIRABREQUIM VAG 1.8/2.0 TFSI 4V (CADEIA)**

~~510,00€~~ **299,00€**



FG 192/VW8C

**FERRAMENTA DE INSTALAÇÃO DA CAMBOTA VAG 1.8/2.0 TFSI 4V (CADEIA)**

Kir associado FG 192/VW8

~~340,00€~~ **219,00€**



FG 192/VW5

**KIT DE AFINAÇÃO VAG 1.8 E 1.8T**

**MODELOS:**  
**AUDI:** A3; S3; TT; A6  
**SEAT:** Ibiza; Cordoba; Leon; Toledo; Alhambra; Octavia  
**VW:** Golf; Passat  
**MOTOR:** 1.8, 1.8 T benzina  
**CÓDIGO MOTOR:** ADR, AEB, AFY, AGN, AGU, AJH, AJL, AJP, AJQ, AMK, AMU, ANB, APG, APH, APP, APT, APU, APX, APY, AQA, AQX, AGR, ARX, ARY, ARZ, ATC, ATW, AUM, AUQ, AVC, AWC, AWP, AWU, AWV, AYP, BAM, BEA, BFV, BKF, BNU, BVP, BVR

~~41,00€~~ **24,90€**



FG 192/VW7D

**KIT DE SINCRONIZACIÓN AUDI 2.5 TFSI / RS PLUS**

**MODELOS:**  
 RS Q3; Q3; TT  
**MOTOR:** 2.5 TFSI / RS PLUS  
**CÓDIGO MOTOR:** CZGA; CZGB; CEPA; CEPB; CTSA

~~340,00€~~ **199,00€**



FG 192/VW7C

**KIT DE AFINAÇÃO VW/AUDI 2.0 FSI & TFSI**

**MODELOS:**  
**AUDI:** A3, A4, TT, A4 Cabrio, S3  
**VOLKSWAGEN:** Golf VI, Touran, Passat, Eos, Jetta, Golf Plus, Scirocco, Golf V  
**MOTOR:** 2.0, 2.0 FSI, 2.0 TFSI  
**Código motor:** AXW, BHD, BMB, AWA, AXX, BPY, BWA, BUL, BPJ, BGB, BWE, BLR, BLX, BLY, BVY, BWT, BPG, CDLA, CDLB, CDLC, CDMA, AXW, CDLF

~~185,00€~~ **99,00€**

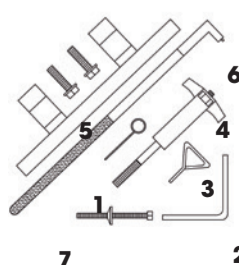

- CONTEÚDO**
- FG 192/VW7C-1 Pino de bloqueio do tensor
  - FG 192/VW7-4 Cavilha de bloqueio do tensor da correia auxiliar
  - FG 192/VW7-5 Pino de bloqueio do tensor
  - FG 192/VW5-1 Ferramenta para fixação
  - FG 192/VW7C-5 Ferramenta de alinhamento do árvore de cames
  - FG 192/VW7C-6 Forquilha de tensão
  - FG 192/VW7C-7 Pasador de bloqueio

# KIT DE AFINAÇÃO



FG 192/VW7

## KIT DE AFINAÇÃO VW 1.2,1.4,1.6,1.9,2.0D TDI PD

### MODELOS:

**VOLKSWAGEN:** Bora, Golf, Golf Estate, Golf Plus, Passat, Lupo, Polo, Sharan, Beetle, Touran, Transporter, Jetta, Caddy, Caddy Maxi, Eos

**AUDI:** A2, A3, A4, A4 Cabrio, A4 Quattro, A6

**SEAT:** Arosa, Cordoba, Ibiza, Alhambra, Leon, Toledo, Altea, Altea XL

**SKODA:** Fabia, Octavia, Octavia Tour, Octavia II, Superb, Roomster

**MOTOR:** 1.2D TDI PD, 1.4D TDI PD, 1.6D TDI PD, 1.9D TDI PD, 2.0D TDI PD

**CÓDIGO MOTOR:** AJM, AMF, ANU, ANY, ARL, ASZ, ATD, ATJ, ATL, AUY, AVB, AVF, AVQ, AWX, AXB, AXC, AXR, AYZ, AZV, BAY, BDJ, BDK, BGW,BHC, BHW, BJB, BKC, BKD, BKE, BKP,BKQ, BLB, BLS,BLT, BMA, BMM, BMN, BMP, BMR, BMS, BMT, BNA, BNM,BNV, BPW, BPX, BRA,BRB,BRC,BRE, BRF, BRM,BRT, BRU, BSS, BSV,BSU,BSW, BTB, BUK, BUY, BUZ, BVA, BVE, BVF, BVG, BVH,BVK, BWV, BXE, BXF

130,00€ 62,50€

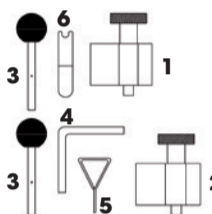

### CONTEÚDO

- FG 192/VW14-2 Ferramenta de bloqueio da posição da cambota
- FG 192/VW7-2 Ferramenta de bloqueio da posição da cambota
- FG 192/VW7-3 Paraárvores de cames da bomba de injeção
- FG 192/VW7-4 Ferramenta de bloqueio do tensor da correia auxiliar
- FG 192/VW7-5 Pino de bloqueio do tensor
- FG 192/F024-15 Forquilha de Tensão



FG 192/VW10B

## KIT DE SINCRONIZACIÓN VAG 1.4, 1.6, 2.0 TDI CR

### MODELOS:

**VOLKSWAGEN:** Golf VII, Golf VII Estate, Golf VII Wagon, Polo

**AUDI:** A3 Cabrio, A3 Saloon, A3/A3 Sportback, A4, A4 allroad, A4 quattro, A5 Coupe/Cabriolet, A5 Sportback, A6, Q5, TT

**SEAT:** Leon, Leon ST

**SKODA:** Octavia III  
**MOTOR:** 1.4TDI CR, 1.6TDI CR, 1.6TDI CR GreenLine/BlueMotion/Ecomotive, 2.0TDI CR/RS TDI/TDI CR Ultra

**CÓDIGO MOTOR:** CKFB, CKFC, CLHA, CLHB, CNHA, CNHC, CRBC, CRBD, CRFA, CRFC, CRKA, CRKB, CRLB, CRLC, CRMB, CRVA, CRVC, CSUA, CSUB, CUNA, CUPA, CUTA, CUSA, CUSB

330,00€ 169,00€

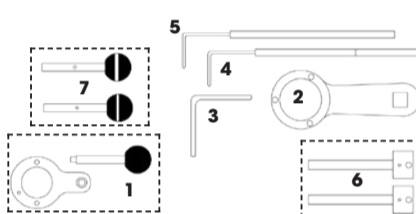

### CONTEÚDO

- FG 192/VW10B-1 Ferramenta de bloqueio del eje del piñón
- FG 192/VW10-7 Bloqueo del piñón de la bomba de combustible de alta presión
- FG 192/VW7-4 Pasador de bloqueotensor de correia componentes auxiliares
- FG 192/VW10-6 Ferramenta de ajuste de la polea del tensor de la correia
- FG 192/VW10-5 Ferramenta de bloqueio polea del tensor de la correia
- FG 192/VW10B-6 Ferramenta de bloqueio bomba combustible alta presión
- FG 192/F024-14 Herramienta de bloqueio del árbol de levas



FG 192/VW14

## KIT DE AFINAÇÃO VAG & FORD

### MODELOS:

**VOLKSWAGEN:** Transporter, Caddy, Golf, Golf Estate, Passat, Polo, Polo Classic, Polo Estate, Sharan, Vento, Bora, Beetle, Lupo

**AUDI:** 80, 90, 100, A6, A3, A4,A8, Allroad

**SEAT:** Cordoba, Ibiza, Toledo, Alhambra, Inca, Arosa

**SKODA:** Felicia, Van, Pick,Up, Octavia, Octavia Tour, Fabia

**FORD:** Galaxy

**MOTOR:** 1.2D TDI PD, 1.4D TDI PD, 1.6, 1.6D, 1.6D TURBO, 1.7D SDI, 1.8, 1.8 TURBO, 1.9D, 1.9D TURBO, 1.9D TDI, 1.9D TDI PD, 2.0, 2.4D, 2.5D TDI, 2.5D SDI, 3.7,4.2

**CÓDIGO MOTOR:** 1X, 1Y, 1Z, AAB, AAT, AAZ, ABL, ABZ, ACE,ACV, ADP, ADR, AEB, AEF, AEL,AEY, AEW, AFB, AFF, AFN,AGD, AGP, AGR, AGX, AHB, AHC, AHD, AHF, AHH, AHL, AHU, AJA, AJM, AKE, AKN, AKU, AKW, ALE, ALH, ALT, AMF, ANU, ANY, AQM, ARL, ASV, ASX, ASZ, ATD, ATJ, AUY, AVB, AVF, AVG, AVJ, AWX, AXR, AYM, AYZ, BAY, CY, JK, RA, SB

260,00€ 129,00€

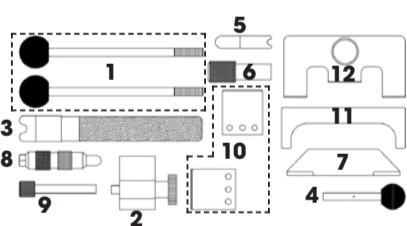

### CONTEÚDO

- FG 192/VW14-1 Guias
- FG 192/VW14-2 Ferramenta de bloqueio da posição da cambota
- FG 192/VW14-3 Forquilha de Tensão
- FG 192/F024-14 Cavilha de bloqueio da árvores de cames
- FG 192/F024-15 Pino de bloqueio do tensor
- FG 192/VW14-6 Ferramenta bloqueio da polie da Bomba de Injeção
- FG 192/VW14-7 Cavilha de bloqueio da árvores de cames
- FG 192/VW14-8 Ferramenta de bloqueio da cambota
- FG 192/VW14-9 Pino de bloqueio
- FG 192/VW14-10 Ferramenta de alinhamento da árvore de cames
- FG 192/F024-13 Ferramenta de bloqueioda árvore de cames
- FG 192/VW14-12 Ferramenta de bloqueio o da árvore de cames



FG 192/VW10

## KIT DE AFINAÇÃO VW, AUDI, SEAT, SKODA 1.6, 2.0 TDI CR

### MODELOS:

**VW:** Beetle/Maggiolino; Golf V; Golf VI Cabri; Golf VI Estate; Golf Plus; Passat; Polo; Jetta; Touran; Caddy/Caddy Maxi

**AUDI:** Q5; A1; A3;A3 Cabrio; A4; A4 allroad; A4 quattro; A5 Coupe/Cabriolet; A5 Sportback; A6

**SEAT:** Ibiza; Leon; Altea / Altea XL; Toledo; Exeo

**SKODA:** Fabia II; Octavia II; Rapid; Praktik; Yeti; Roomster; Superb II

**MOTOR:** 1.6, 2.0 TDI CR (diesel a cinghina)

**CÓDIGO MOTOR:** CAYB; CAYC; CAYA; CAGA; CAGB; CAGC; CAHA; CAHB; CFHC; CBAA; CBAB; CFFB; CGLA; CGLB;CAAA; CAAB; CAAC; CBAB; CBAC; CBBA; CBBB; CBDA; CBDB; CBDC; CFJA; CFWA; CJCA; CJCB; CJAA; CCHA; CEGA

290,00€ 139,00€

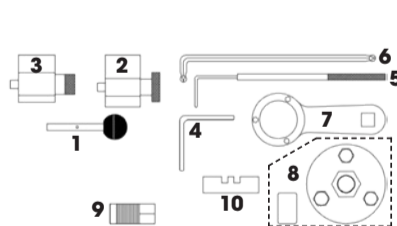

### CONTEÚDO

- FG 192/F024-14 Cavilha alinhamento árvores de cames da bomba de injeção
- FG 192/VW10-2 Ferramenta de bloqueio da posição da cambota
- FG 192/VW10-3 Ferramenta de bloqueio da posição da cambota
- FG 192/VW7-4 Ferramenta de bloqueio da tensor da correia auxiliar
- FG 192/VW10-5 Ferramenta de bloqueio da tensor
- FG 192/VW10-6 Pararegula çãopolea de tensão da correia de transmissão
- FG 192/VW10-7 Ferramenta de bloqueio do carroto
- FG 192/VW10-8 Extractor do cubo da árvore de cames
- FG 192/VW10-9 Extractor do cubo da árvore de cames
- FG 192/VW10-10 Ferramenta para alinhar módulo do veio de equilíbrio



FG 192/VW7B

## KIT DE AFINAÇÃO VOLKSWAGEN 2.4, 2.5 TDI

### MODELOS:

LT; Crafter; Transporter T4

**MOTOR:** 2.4, 2.5 Tdi

**CÓDIGO MOTOR:** ANJ; BJJ; BJK; BJL; BJM; AAB; AJA

175,00€ 99,00€

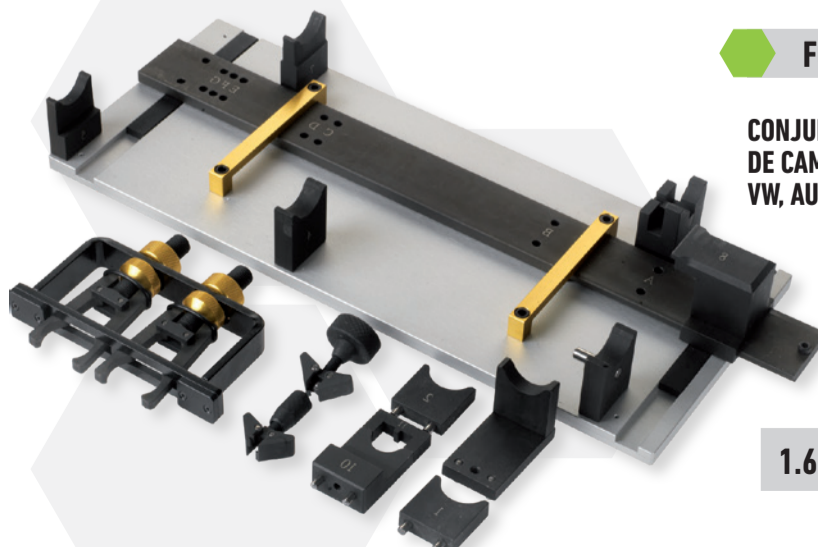

FG 192/VW11

## CONJUNTO DE MONTAGEM ÁRVORE DE CAMES DE CABEÇA MOTOR VW, AUDI, SEAT, SKODA 1.6, 2.0 TDI CR

1.680,00€ 999,00€

FG 192/VW9



**KIT DE AFINAÇÃO VAG 2.5 TDI V6 - CADEIA**

**MODELOS:**

**VOLKSWAGEN:** Passat

**AUDI:** A4; A4 quattro; A6; A6 quattro; A8; Allroad; A4 Cabrio

**SKODA:** Superb

**MOTOR:** 2.5 Tdi

**CÓDIGO MOTOR:** AFB; BAU; AKE; AKN; BDG; BDH; AFB; BAU; AKE; AKN; AYM; BCZ; BDG; BDH; BFC; AYM; BDG

~~155,80€~~ **79,90€**



FG 192/VW6



**KIT DE AFINAÇÃO VOLKSWAGEN 2.5 TDI PD**

**MODELOS:**

Transporter, Touareg

**MOTOR:** 2.5 TDI PD

**CÓDIGO MOTOR:**

AXD; AXE; BAC; BLJ; BLK; BNZ; BPC; BPD; BPE

~~470,80€~~ **269,00€**

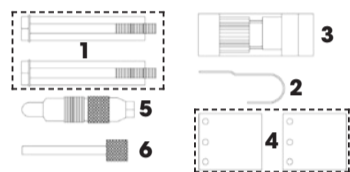

**CONTEÚDO**

- FG 192/VW9-1 Guias de apoio (2 peças)
- FG 192/VW9-2 Cavilha de bloqueio do tensor
- FG 192/VW9-3 Chave do tensor
- FG 192/VW9-4 Ferramenta de alinhamento da árvore de cames
- FG 192/VW9-5 Ferramenta de bloqueio da cambota
- FG 192/VW14-9 Cavilha de bloqueio de bomba de injeção

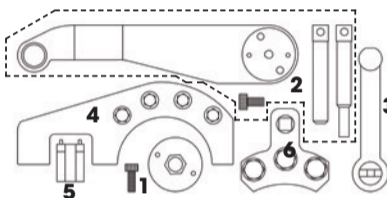

**CONTEÚDO**

- FG 192/VW6-1 Ferramenta de alinhamento da cambota
- FG 192/VW6-2 Ferramenta de bloqueio da cambota
- FG 192/VW6-3 Ferramenta de bloqueio da árvore de cames
- FG 192/VW6-4 Ferramenta de retenção engrenagem árvore de cames
- FG 192/VW6-5 Ferramenta de pré-tensão da engrenagem de compensação da cambota
- FG 192/VW6-6 Ferramenta de retenção da engrenagem da árvore de cames

FG 192/VW6B



**KIT DE AFINAÇÃO VOLKSWAGEN 2.5 TDI PD**

**MODELOS:**

Transporter, Transporter T5, Touareg

**MOTOR:** 2,5 TDI PD

**CÓDIGO MOTOR:** AXD, AXE, BAC, BLJ, BLK, BNZ, BPC, BPD

~~175,80€~~ **99,00€**



FG 192/VW12



**KIT DE AFINAÇÃO VW/AUDI 2.7D, 3.0D TDI V6, 4.0D, 4.2D TDI V8 (CADEIA DE DISTRIBUIÇÃO)**

**MODELOS:**

**AUDI:** A4, A4 Cabrio, A6, A6 allroad, A5 Coupe/Cabriolet, A5 Sportback, A8, Q7, Q5, A5 Coupe/

**MOTOR:** 2.7TDI, 2.7TDI CR, 3.0TDI, 3.0TDI CR, 4.0TDI CR, 4.2TDI CR

**CÓDIGO MOTOR:** BPP, BSG, CAMA, CAMB, CANA, CANB, CANC, CAND, CGKA, CGKB, ASB, BKN, BMK, BMZ, BNG, BUG, CAPA: CASA, CASB, CCLA, CCMA, CCWA, CCWB, CDTA, CDTB, CDUC, CDYA, CDYB, CDYC, CJGA, CJGC, CKVB, CKVC, CLAA, CLAB, CLZB, ASE, BVN, CDSB, CCEA, BTR

~~300,80€~~ **169,00€**



**NEW** FG 192/VW5C



**KIT DE AFINAÇÃO VAG/PORSCHE 2.5, 2.8, 3.2 FSI E 3.0 TFSI**

**MODELOS:**

**PORSCHE:** Cayenne, Panamera

**Volkswagen:** Touareg

**AUDI:** A4, A5, A6, A7, A8, Q5, Q7, S4, S5, SQ5

**MOTOR:** 2.5FSI; 2.8FSI; 3.2FSI; 3.0TFSI; 3.0HybridS; 3.0TFSI Hybrid

**CÓDIGO MOTOR:**

**PORSCHE:** M06/EC; CGEA

**Volkswagen:** CGFA; CJTA; CGEA

**AUDI:** CREA; CREC; CRED; CHMB; CGWD; CGXB; CHMA; CTTA; CTUA; CTVA; CTWA; CTWB; CGWC; CTXA; CTUD; CALA; BDX; CCDA; CCEA; CALB;

~~300,80€~~ **189,00€**

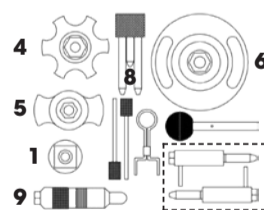

**CONTEÚDO**

- FG 192/VW12-2 Cavilhas de bloqueio da árvore de cames(2)
- FG 192/VW12-3 Cavilha de bloqueio do tensor(2)
- FG 192/VW12-4 Ferramenta de alinhamento/bloqueio da árvore de cames
- FG 192/VW12-5 Ferramenta de retenção do carreto da árvore de cames
- FG 192/VW12-6 Ferramenta de rodagem da cambota-Tipo2
- FG 192/VW12-7 Ferramenta de bloqueio da tensor(3)
- FG 192/VW12-8 Ferramenta de bloqueio da poliedra Bomba de Injeção
- FG 192/VW14-8 Ferramenta de bloqueio da cambota
- FG 192/ F024-14 Cavilha de fixação da bomba de injeção

FG 192/V01



**FERRAMENTA DE SUPORTE DE POLIA DO CAMBOTA DO MOTORES VOLVO DIESEL**

**MODELOS:**

C30, C70, S40, V50, C30 D5, C70 D5, S60, V70, XC70 T

**MOTOR:**

2.0 D, 2.3 D, 2.4D, 2.5D, 2.8D, 2.9D



~~115,80€~~ **59,90€**

FG 192/CO



**INDICADOR UNIVERSAL**

Range: 0-8mm

Leitura: 0.01mm



~~92,00€~~ **49,90€**

FG 192/PM



**LOCALIZADOR DO PONTO MORTO SUPERIOR (TDC)**



~~78,00€~~ **39,90€**

# KIT DE AFINAÇÃO



FG 192/HI7



## EXTRATOR DE CARRETO DA BOMBA DE ALTA PRESSÃO HYUNDAI/KIA

### MODELOS:

**HYUNDAI:** Matrix; Accent/Excel; Getz; i10; Elantra; i30; i20; ix35; ix20; i40; i20 Coupe; Tucson  
**KIA:** Cerato; Rio; Picanto; Cee'd; Pro-Cee'd; Soul; Venga; Sportage; Carens; Optima

**MOTOR:** 1.1, 1.4, 1.5, 1.6, 1.7 CRDi

**CÓDIGO MOTOR:** D3FF; D3FA; D4FC; D4FA; D4FB-H (U2); D4FB-L (U2); D4FB-H (U1); D4FB

~~190,00€~~ 109,00€

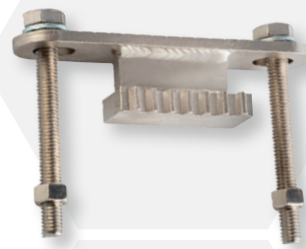

FG 192/HI7B



## FERRAMENTA DE TRAVAMENTO VOLANTE DIESEL HYUNDAI / KIA

~~95,00€~~ 55,90€



FG 192/HI1



## EXTRATOR DE CARRETO DA BOMBA DE ALTA PRESSÃO HYUNDAI/KIA

~~95,00€~~ 55,90€



FG 192/TY15



## FERRAMENTA DE BLOQUEIO POLIA VIRABREQUIM POLIA ÁRVORE DE CAMES

**MODELOS: LEXUS:** GS; LS; LX; RX

**TOYOTA:** Auris; Avensis; Corolla; Aygo; Celica; Corolla Verso/CombiVan

**MOTOR:** 1.0; 1.3; 1.4; 1.6; 2.0; 2.2; 2.4; 2.5; 2.7; 2.8; 3.0; 3.4; 3.5; 4.7

**CÓDIGO MOTOR:** 1UZ-FE; 1MZ-FE; 3MZ-FE; 3UZ-FE; 4ZZ-FE; 1CD-FTV; 1ZZ-FE; 3ZZ-FE; 2ZZ-GE; 2KD-FTV; 2KD-FTV H; 2KD-FTV L; 1KD-FTV; 2UZ-FE; 2SZ-FE

~~170,00€~~ 79,00€



FG 192/HI2



## FERRAMENTA DE TRAVAMENTO VOLANTE DIESEL HYUNDAI / KIA

**HYUNDAI:** Accent; Elantra; Genesis Coupe; Grand Santa Fe; H1/H300; i10; i20; i30; i40; i800; ix20; ix35; Santa Fe; Sonata; Sonica; Tucson; Tiburon  
**KIA:** Venga; Sportage; Sorento; Soul; Rio; Pro-Cee'd; Picanto; Optima; Carens

**MOTOR:** 1.0; 1.2; 1.25; 1.4; 1.6; 2.0; 2.2; 2.4; 2.7

**CÓDIGO MOTOR:** G3LA; B3LA; G3LC; G4LA; G4; G4LA; G4LC; G4FA; G4FA-L; G4FC; G4FC-GL; G4FDG4FJ; G4KD; G4KF; G4NC; G4NA; G4ND; G4NE; DAHA-H; D4HA-L; D4HA; D4HB; G4KE; G4KJ; G6BA

~~135,00€~~ 79,00€

FG 192/H05



~~85,00€~~ 49,90€

## KIT DE AFINAÇÃO HONDA 1.6-3.0 (SOHC E DOHC)

**MODELOS:** Civic; Accord; Prulde; Shuttle; Odyssey

**MOTOR:** 1.6, 1.8, 2.0, 2.2; 2.3; 3.0

**CÓDIGO MOTOR:** 1.6: B16A21.8; F18A3, F18B2, F18B4 2.0: F20AF, F20B3, F20B5, F20B6, F20B7, F20Z1, F22Z2, F22B5, F22B8, F22A2, H22A5, H22A7, H22A8 2.3: F23A7, F23Z5, H23A2, H23A3 3.0: J30A1

FG 192/DW2



~~92,00€~~ 59,00€

## CHAVES PARA BOMBA DE ÁGUA PARA MOTORES CHEVROLET E DAEWOO

**MODELOS: CHEVROLET:** Aveo, Cruze, Kalos, Lacetti, Tacuma/Rezzo, Nubira

**DAEWOO:** Kalos, Lacetti, Lanos, Nubira, Nexia/Cielo/Racer, Tacuma/Rezzo

**MOTOR:** 1.4, 1.5, 1.6, 1.8

**CÓDIGO MOTOR:** F14D3, F16D3, A16DMS, G15MF, A15MF, F14S3, A15DM, A15SMS, A16DM, F18N

FG 192/HI5



~~60,00€~~ 35,00€

## KIT DE AFINAÇÃO HYUNDAI, MITSUBISHI E PROTON

**MODELOS: HYUNDAI:** Lantra/Elantra; Sonata; Santa Fe; Trajet

**MITSUBISHI:** 3000 GT; Colt; Lancer; Carisma; Space Star; Pajero Pinin; Galant; Space runner; Grandis; Triton

**PROTON:** Persona; 418; Satria; Wira; M21 Coupe

**MOTOR:** 1.6, 1.8, 2.0, 2.4, 3.0, 3.5

**CÓDIGO MOTOR:** 1.6: 4G61, G4-R - 1.8: 4G67, 4G93, 4G93P, G4-N 2.0: 4G63, 4G94, G4CP, G4JP, G4-P 2.4: 4G64, 4G69, G4JS 3.0: 6G72 - 3.5: 6G74



FG 192/TY45



## KIT DE AFINAÇÃO TOYOTA, LEXUS

### MODELOS:

**TOYOTA:** 4-Runner, Auris, Avensis, Camry, Celica, Corolla, Corolla Verso/CombiVan, Dyna, Hiace, Hilux, Landcruiser, Landcruiser/Prado, MR2, Picnic/SportVan, Previa, Prius, RAV4, Starlet, Tarago, Verso, Verso/Sportsvan, Vienta, Yaris

**LEXUS:** GS, IS, LS, LX, RX, SC

**MOTOR:** 1.0, 1.3, 1.4, 1.6, 2.0, 2.2, 2.4, 2.5, 2.7, 2.8, 3.0, 3.4, 3.5, 4.7

### CÓDIGO MOTOR:

1SZ-FE, 2SZ-FE, 4G15, 4G93, 2ZR-FAE, 1ZZ-FE, 2AD-FHV, 2AD-FTV, 1AD-FTV, 1CD-FTV, 1MZ-FE, 4E-FE, 2L, 3ZZ-FE, 4ZZ-FE, 3L, 2TR-FE, 2KD-FTV, 2L-T, 1GR-FE, 5VZ-FE, 5L, 2ZR-FE

~~600,00€~~ 349,00€

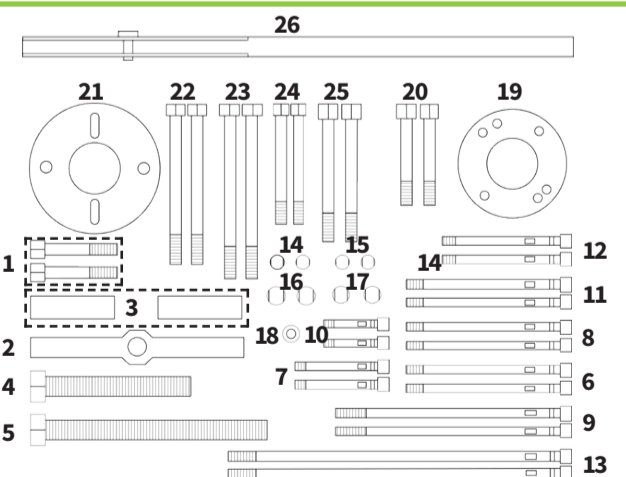

### CONTEÚDO

FG 192/TY45-1 Parafusos M8x55  
FG 192/TY45-2 Extrator de polido virabrequim  
FG 192/TY45-3 Braço extractor  
FG 192/TY45-4 Parafuso central L: 100mm  
FG 192/TY45-5 Parafuso central L: 150mm  
FG 192/TY45-6 Griffa M5x100  
FG 192/TY45-7 Griffa M8x50  
FG 192/TY45-8 Griffa M8x100  
FG 192/TY45-9 Griffa M5x150  
FG 192/TY45-10 Griffa M6x30  
FG 192/TY45-11 Griffa M6x100  
FG 192/TY45-12 Griffa M8x75  
FG 192/TY45-13 Griffa M8x225

FG 192/TY45-14 Adaptador M10x1.25  
FG 192/TY45-15 Adaptador M10x1.5  
FG 192/TY45-16 Adaptador M12x1.25  
FG 192/TY45-17 Adaptador M12x1.5  
FG 192/TY45-18 Adaptador  
FG 192/TY45-19 Extrator da polia do virabrequim  
FG 192/TY45-20 Parafusos M8x65  
FG 192/TY45-21 Extrator da polia do virabrequim  
FG 192/TY45-22 Parafusos M8x106  
FG 192/TY45-23 Parafusos M8x116  
FG 192/TY45-24 Parafusos M6x80  
FG 192/TY45-25 Parafusos M8x88  
FG 192/TY45-26 Alça universal