



# PROMODAY 2025

















PORTUGAL € IVA ÑAO INCLUIDA



IMPORTADOR EXCLUSIVO



**MEMODERIVA**<sup>®</sup>  
MAQUINAS & EQUIPAMENTOS INDUSTRIAIS

<b>04</b>	CHAVES DE APERTO	
<b>08</b>	CHAVES DE CAIXAS	
<b>14</b>	CHAVES DE FENDA E ALICATES	
<b>18</b>	ELETRÓNICA E ELETROTÉCNICA	
<b>20</b>	CHAVES DINAMOMETRICAS	
<b>22</b>	FERRAMENTAS DE CORTE	
<b>24</b>	MANUTENÇÃO GENERAL	
<b>32</b>	ILUMINAÇÃO	
<b>42</b>	POWER TOOLS	
<b>48</b>	EXTRACTORES	
<b>50</b>	FERRAMENTAS DE AR	
<b>58</b>	CARROS E BANCOS	
<b>104</b>	MOBÍLIA TÉCNICA	
<b>118</b>	MOBILIÁRIO PARA VANS	
<b>124</b>	AUTOMOTIVE	
<b>144</b>	PROFESSIONAL EQUIPMENT	





# CHAVES DE APERTO



## FG 600/A

INDUSTRIAL

### NOVA CHAVE POLIGONAL DE BOCA/LUNETETA

**DESIGN DE CABEÇA OTIMIZADO**  
Para uma elevada força de fixação

**ALTO DESEMPENHO**  
Atinge valores de binário duas vezes superiores ao padrão

**CABEÇA POLIGONAL DESLOCADA**  
Inclinado 15° para aceder às porcas e parafusos embutidos na superfície de trabalho e proteger a mão do utilizador



FG 600A/SC16

245,00€

149,00€

**JOGOS CHAVES DE BOCA/LUNETAS POLIGONAIS - INDUSTRIAL**

Conteúdo: 6, 7, 8, 10, 12, 13, 14, 16, 17, 19, 21, 22, 24, 27, 30, 32mm

FG 600A/SC25

405,00€

229,00€

**JOGOS CHAVES DE BOCA/LUNETAS POLIGONAIS - INDUSTRIAL**

Conteúdo: 6, 7, 8, 10, 12, 13, 14, 15, 16, 17, 18, 19, 20, 21, 22, 23, 24, 25, 26, 27, 28, 30, 32

NEW



FG 600/SC16

232,00€

139,00€

**JOGOS CHAVES DE BOCA/LUNETAS POLIGONAIS**

Conteúdo: 6, 7, 8, 10, 12, 13, 14, 16, 17, 19, 21, 22, 24, 27, 30, 32mm

FG 600/SC25

385,00€

209,00€

**JOGOS CHAVES DE BOCA/LUNETAS POLIGONAIS**

Conteúdo: 6, 7, 8, 10, 12, 13, 14, 15, 16, 17, 18, 19, 20, 21, 22, 23, 24, 25, 26, 27, 28, 30, 32mm



FG 602/SC13

150,00€

95,00€

**JOGOS CHAVES DE BOCAS**

Conteúdo: 6x7, 8x9, 10x11, 12x13, 14x15, 16x17, 18x19, 20x22, 21x23, 24x26, 25x28, 27x29, 30x32mm



**NOVA CHAVE  
POLIGONAL  
DE BOCA/LUNETA  
TWISTER**

**NEW**

A nova chave TWISTER da Fasano Tools tem um design único e inovador: a rotação do cabo faz com que o garfo e a cabeça poligonal fiquem perpendiculares entre si, de modo a que o utilizador segure a chave pelo lado plano, tendo mais área de superfície.

Isto permite que a força de aperto seja aumentada em mais de 20% em comparação com os interruptores comuns, reduzindo significativamente a tensão e a fadiga das mãos durante a utilização.

**+ FORÇA DO TORQUE**



**FG 600TW/S12**

**190,00€**

**115,00€**

**JOGO DE CHAVES POLIGONALES DE BOCA/LUNETA TWISTER**

Conteúdo: 8, 9, 10, 11, 12, 13, 14, 15, 16, 17, 18, 19mm

**NEW**



**FG 600XL/SC11**

**368,00€**

**219,00€**

**JOGO DE CHAVES DE LUNETA DUPLAS DIREITAS, SÉRIE EXTRALONGA**

Conteúdo: 8x10, 10x12, 11x13, 12x14, 13x15, 14x17, 16x18, 17x19, 20x22, 21x23, 22x24mm

**NEW**



**FG 615/SC8**

**116,00€**

**69,90€**

**JOGOS DE CHAVES DE LUNETA CON CURVADURA**

Conteúdo: 6x7, 8x9, 10x11, 12x13, 14x15, 16x17, 18x19, 20x22mm



**FG 614C/S8**

**265,00€**

**139,00€**

**JOGO DE CHAVES DE CAIXA COM ARTICULAÇÃO DUPLA**

Conteúdo: 6x7, 8x9, 10x11, 12x13, 14x15, 16x17, 18x19, 20x22 mm



**FG 180/SP9**

**216,00€**

**129,00€**

**JOGOS CHAVES DE LUNETA ABERTA**

Conteúdo: 8x10, 10x11, 11x13, 12x14, 17x19, 19x22, 24x27, 30x32mm



**FG 613/S11**

**225,00€**

**139,00€**

**JOGO CHAVES DE CACHIMBO HEXAGONAIS-POLIGONAIS**

Conteúdo: 6, 7, 8, 10, 11, 12, 13, 14, 17, 19, 22mm





FG 623H/S6

132,00€

79,20€

JOGO DE CHAVES EM T HEXAGONAIS COM VEIO FIXO

Conteúdo: 2,5, 3, 4, 5, 6, 8mm

FG 623H/S8

186,00€

119,00€

JOGO DE CHAVES EM T HEXAGONAIS COM VEIO FIXO

Conteúdo: 2, 2,5, 3, 4, 5, 6, 8, 10mm

FG 623H/S14

375,00€

€239,00€

JOGO DE CHAVES EM T HEXAGONAIS COM VEIO FIXO

Conteúdo: 2, 2,5, 3, 3,5, 4, 4,5, 5, 6, 7, 8, 9, 10, 12, 14mm



NEW



## NOVA CHAVE T SEXTAVADA

NEW



INDUSTRIAL

### DESEMPENHO E ERGONOMIA

A nova chave com cabo em T da Fasano Tools foi concebida para proporcionar um elevado binário. O cabo fixo e o aço especial Cromo Vanádio garantem um elevado nível de resistência.

A ergonomia foi significativamente melhorada graças ao novo design, enquanto as pontas polidas até 8 mm permitem trabalhar com a máxima precisão.

### AÇO CROMO VANÁDIO

FG 621H/S8

139,00€

85,00€

JOGOS CHAVES EM T COM PONTAS

Conteúdo: 2, 2,5, 3, 3,5, 4, 5, 6, 8mm

FG 621H/S8C

152,00€

89,00€

JOGOS CHAVES EM T COM PONTAS CON VARILLA DESLIZANTE

Conteúdo: 2, 2,5, 3, 4, 5, 6, 8, 10mm

FG 621H/S14

298,00€

179,00€

JOGOS CHAVES EM T COM PONTAS CON VARILLA DESLIZANTE

Conteúdo: 2, 2,5, 3, 3,5, 4, 4,5, 5, 6, 7, 8, 9, 10, 12, 14mm



FG 618/S7B

265,00€

€159,00€

JOGOS CAIXA HEXAGONAIS COM CARDAN E CABO EM T

Conteúdo: 7, 8, 10, 12, 13, 14, 17mm

FG 618/S7

293,00€

€179,00€

JOGOS CAIXA HEXAGONAIS COM CARDAN E CABO EM T

Conteúdo: 8, 10, 11, 13, 14, 17, 19mm

FG 618/S10

418,00€

249,00€

JOGOS CAIXA HEXAGONAIS COM CARDAN E CABO EM T

Conteúdo: 8, 10, 11, 12, 13, 14, 15, 16, 17, 19mm





**FG 39/S4**

~~180,00€~~

**109,00€**

**JOGO DE 4 CHAVES DE BÚSSOLA COM PONTAS INTERCAMBIÁVEIS**

Conteúdo: 1.5/2.5mm, 2.0/3.0mm, 3.0/5.0mm, 4.0/6.0mm, 5.0/7.0mm, 6.0/8.0mm, 8.0/10.0mm, 8.0/12.0mm



**FG 605/ST11-B**

~~238,00€~~

**145,00€**

**JOGO DE CHAVES DE BOCA/LUNETETA CON SISTEMA DE ROQUETE REVERSÍVEL**

Conteúdo: 8, 9, 10, 11, 12, 13, 14, 15, 16, 17, 19mm



Anel de aço integrado para segurar o parafuso.

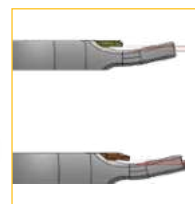

Banco de corrida traseiro com perna angular por baixo para maior espaço de manuseamento

**FG 606/SP9**

~~135,00€~~

**85,00€**

**JOGO DE CHAVES COMBINADAS NÃO REVERSÍVEIS**

Conteúdo: 8, 10, 11, 12, 13, 14, 15, 17, 19mm



**FG 615A/S6**

~~130,00€~~

**75,00€**

**JOGO DE 6 CHAVES DE PORCAS DUPLAS COM ROQUETE UNIVERSAL REVERSÍVEL DE 90 DENTES**

Conteúdo: 8x9, 10x11, 12x13, 14x15, 16x18, 17x19mm



**FG 605/SC15**

~~265,00€~~

**159,00€**

**JOGO DE CHAVES COMBINADAS REVERSÍVEL**

Conteúdo: 6, 7, 8, 9, 10, 11, 12, 13, 14, 15, 16, 17, 18, 19, 22mm



**FG 610FL/SP11**

~~295,00€~~

**179,00€**

**JOGO DE CHAVES COMBINADAS ESSÍVEL**

Conteúdo: 8, 10, 11, 12, 13, 14, 15, 16, 17, 18, 19mm



**FG 622A/S2**

~~80,00€~~

**49,00€**

**JOGO DE CHAVES DE CATRACA UNIVERSAL 2 SÉRIES EXTRA LONGAS**

Conteúdo: 21x22, 24x27 mm







# CHAVES DE CAIXAS



**FG 624/S25**







~~90,00€~~

**49,90€**

**JOGO 25 FERRAMENTAS COM ATAQUE DE 1/4"**



**CONTENTE**

	FG 624/E	6,8,10,11,12,13mm
	FG 624/CR14	
	FG 89/38PI1	1/4" x 1/4"
	FG 85/25PH	1, 2, 3
	FG 85/25PZ	1, 2, 3
	FG 85/25F	4, 5, 6, 7
	FG 85/25TX	10, 15, 20, 25, 27, 30, 40



**FG 624/S25A**

~~85,00€~~

**49,90€**

**JOGO 25 FERRAMENTAS COM ATAQUE DE 1/4"**



**CONTENTE**

	FG 624/E	5, 6, 8, 10, 11, 13mm
	FG 624/MCH14	
	ADATTATORE	1/4" x 1/4"
	FG 85/25PH	1, 2, 3
	FG 85/25PZ	1, 2, 3
	FG 85/25F	3, 5
	FG 85/25H	4, 5, 6
	FG 85/25TX	10, 15, 20, 25, 30, 40



**FG 624/S45**



~~210,00€~~

**129,00€**

JOGO 45 FERRAMENTAS COM ATAQUE DE 1/4"



**CONTENTE**

	FG 624/E	4, 5, 6, 7, 8, 9, 10, 11, 12, 13, 14mm
	FG 624/CR14	
	FG 624/ES14	
	FG 624/PA	50, 100
	FG 624/PRF150	
	FG 624/SN14	
	FG 624/GR14C	
	FG 148/H, FG 148/TX, FG 148/PH, FG 148/F	1,5-10, 8-40, 1-4, 1-5



**FG 624B/S80**

~~200,00€~~

**119,00€**

JOGO 80 FERRAMENTAS 3/8"



**CONTENTE**

	FG 624/B	8,9,10,11,12,13,14,15,16,17,18,19, 21,22,23
	FG 624B/L	8,10,13,17,19
	FG 624/CR38	
	FG 625/SN38	
	FG 149/H FG 149/TX	3,4,5,6,7,8,10 9,10,15,20,25,27,30,40
	FG 624/ES38	
	FG 624B/PA	75,125,150,250
	FG 600/B8	8,10,13,15,17,19
	FG 89/50PI2	3/8"x1/4"
	FG 85/25PH FG 85/25PZ FG 85/25SL FG 85/H FG 85/25T FG 88/60PI2	1,2,3 1,2,3 3,4,4,5,5,5,5,6,6,5 1,5,2,2,5,3,4,5,6 9,10,15,20,25,27,30,40



**FG 625/S27**





~~190,00€~~

**109,00€**

JOGO DE 27 FERRAMENTAS DE 1/2"



**CONTENTE**

	FG 625/A	8,9,10,11,12,13,14,15,16,17,18,19,20, .21,22,23,24,25,26,27,30,32
	FG 625/CR12	
	FG 625/SN12	
	FG 625/ES12	
	FG 625/PA	125,250



## FG BEST 108

270,00€

139,00€

JOGO DE 108 FERRAMENTAS 1/4" Y 1/2"



### CONTENTE

	FG 625/A	10,11,12,13,14,15,16,17,18,19,20,21, 22,23,24,27,30,32
	FG 624/E	4,4.5,5.5,6,7,8,9,10,11,12,13,14
	FG 625L/A	14,15,17,19,22
	FG 624E/L	6,7,8,9,10,11,12,13
	FG 625/TX	10,11,12,14,16,18,20,24
	FG 624/TX	4,5,6,7,8
	FG 181/B	16,21
	FG 624/CR14	
	FG 625/CR12	

	FG 625/SN12	
	FG 624/SN14	
	FG 625/ES12	
	FG 624/ES14	
	FG 624/GR14	
	FG 625/PR	125
	FG 624/PR	50,100
	FG 87/AD	
	FG 139/D	1.5,2,2.5
	FG 147/	PH (1,2), PZ (1,2), SL (4, 5.5, 6.5), H (4,5.5,6.5), TX (10,15,20,25,30)
	FG 85/	PH (3,4), PZ (3,4), SL (8,10,12), H (7,8,10,12,14), TX (40,45,50,55,60)



## FG BEST 171

400,00€

199,00€

JOGO DE 171 FERRAMENTAS 1/4", 3/8" Y 1/2"



### CONTENTE

	FG 625/A	10,11,12,13,14,15,16,17,18,19,20,21, 22,23,24,27,30,32
	FG 624/B	10,11,12,13,14,15,16,17,18,19
	FG 624/E	4,4.5,5.5,6,7,8,9,10,11,12,13,14
	FG 625L/A	16,17,18,19,22
	FG 624B/L	10,11,12,13,14,15
	FG 624E/L	4,5,6,7,8,9,10
	FG 625/TX	20,24
	FG 624B/TX	10,11,12,14,16,18
	FG 624/TX	4,5,6,7,8
	FG 181/B	16,21

	FG 624/CR14	
	FG 624/CR38	
	FG 625/CR12	
	FG 624/SN14	
	FG 624/SN38	
	FG 625/SN12	
	FG 625/ES12	
	FG 624/ES14	
	FG 624/GR14	
	FG 625/PR125	125
	FG 624B/PR125	125
	FG 624/PR50,100	50,100
	FG 87/AD	
	FG 139/D	1,1.5,2,2.5,3,4,4.5,5
	FG 147/	PH (0,1,2), PZ (0,1,2), SL (4,5.5,6.5,7), H (3,4,5), TX (8-30), RTX (8-30)
	FG 85/	PH (3,4), PZ (3,4), SL (8,10,12), H (7,8,10,12,14), TX (40-50), TT (10-45), M (5-9)





**FG 625/S110**

~~480,00€~~









**259,00€**

**JOGO DE 110 FERRAMENTAS DE 1/4" E 1/2"**



**CONTENTE**

	FG 625/A	8,9,10,11,12,13,14,15,16,17,18,19,20,21,22,23,24,25,26,27,30,32
	FG 624/E	4,5,6,7,8,9,10,11,12,13,14
	FG 624/CR14	
	FG 625/CR12	
	FG 625/SN12	
	FG 624/SN14	
	FG 625/ES12	
	FG 624/ES14	
	FG 624/GR14C	
	FG 625/PA	125, 250
	FG 624/PA	50, 100
	FG 89/38PI1	1/4"x1/4"
	FG 85/25PH	1,2,3
	FG 85/25SL	3,4,4.5,5,5.5,6,6.5
	FG 85/25PZ	1,2,3
	FG 85/H	1.5,2,2.5,3,4,5,6
	FG 85/25T	9,10,15,20,25,27,30,40
	FG 88/60P12	

	FG 139/B	
	FG 48/L	
	FG 49	
	FG 600/B	8,10,11,12,13,14,15,17,19
	FG 22	3x75, 4x100, 5.5x100
	FG 22/PH	0x60, PH1x80, PH2x100
	FG 59XT/160	
	FG 63XT/160	
	FG 58/B240	
	FG 132/H500	
	FG 79/SP	
	FG 93/M24	
	FG 44/MT5	



**FG 150TX/S32**

~~196,00€~~

**125,00€**

**JOGO 32 CHAVES DE PONTA TORX 1/2"**



**CONTENTE**

	FG 150/TX	20 - 70
	FG 150L/TX	20 - 70
	FG 150XL/TX	40 - 70
	FG 150XXL/TX	40 - 70





## FG 150M/S26

180,00€

109,00€

### JOGO 26 CHAVES DE PONTA XZN 1/2"



#### CONTENTE

	FG 150/M	5 - 16
	FG 150L/M	5 - 16
	FG 150XL/M	5 - 14
	FG 150XXL/M	8 - 14



## FG 150H/S30

200,00€

119,00€

### JOGO 30 CHAVES DE PONTA HEXAGONAIS



#### CONTENTE

	FG 150/H	5 - 19
	FG 150L/H	5 - 13
	FG 150XL/H	5 - 14
	FG 150XXL/H	5 - 12



## FG 629A/S15

620,00€

339,00€

### JOGO CAIXAS HEXAGONAIS 3/4"



#### CONTENTE

	FG 629/A	19,22,24,27,30,32,36,41,46,50,60mm
	FG 629/CR34	
	FG 629/SN34	
	FG 629/ES34	
	FG 629/PR200	



## FG 629B/S15

620,00€

339,00€

### JOGO CAIXAS POLIGONAIS 3/4"



#### CONTENTE

	FG 629/B	19,22,23,27,30,32,36,41,46,50,60mm
	FG 629/CR34	
	FG 629/SN34	
	FG 629/ES34	
	FG 629/PR200	

**FG 152/RTXS10**

~~165,00€~~

**99,00€**

**JOGO DE 10 CHAVES DE PONTA TORX**

Conteúdo: RTX20, RTX25, RTX27, RTX30, RTX40, RTX45, RTX50, RTX55, RTX60, RTX70



**FG 629C/S10**

~~310,00€~~

**169,00€**

**JOGO 10 CHAVES DE CAIXA DE IMPACTO HEXAGONAIS DA 3/4" EM CAIXA DE ACCIAIO**

Conteúdo: 17,19,22,24,27,30,32,36,41,46mm



**FG 152RH/S9**

~~125,00€~~

**69,00€**

**JOGO DE 9 CHAVES DE PONTA HEXAGONALES**

Conteúdo: RH5, RH6, RH7, RH8, RH10, RH12, RH14, RH17, RH19



**FG 152RM/S9**

~~125,00€~~

**69,00€**

**JOGO DE 9 CHAVES DE PONTA XZN - 1/2"**

Conteúdo: RM5, RM6, RM8, RM9, RM10, RM12, RM14, RM16, RM18



**FG 630A/S14**

~~870,00€~~

**499,00€**

**JOGO 14 CHAVES DE CAIXA DE IMPACTO HEXAGONAIS 1" EM CAIXA DE ACCIAIO**

Conteúdo: 24,27,30,32,33,34,36,38,41,46,50,55,60,65mm



**FG 625AM/S3**

~~49,50€~~

**29,90€**

**JOGO 3 ADAPTADORES MAGNÉTICOS SUPER PLANOS**

Conteúdo: 1/4"x3/8", 3/8"x1/2", 1/2"x3/4"



**CHAVE  
BÚSSOLA  
1/2"  
HEXAGONAL  
REFORÇADO**



**EXTRAPLANO**

**FG 628/S6**

~~95,00€~~

**55,00€**

**JOGO DE 6 LLAVES DE VASO HEXAGONALES REFORZADAS PLANO - CONEXIÓN 1/2"**

Conteúdo: 24,27,30,32,33,34,36,38,41,46,50,55,60,65mm



**FG 628/S12**

~~130,00€~~

**79,00€**

**JOGO DE 12 LLAVES DE VASO HEXAGONALES REFORZADAS PLANO - CONEXIÓN 1/2"**

Conteúdo: 24,27,30,32,33,34,36,38,41,46,50,55,60,65mm





# CHAVES DE FENDA E ALICATES

FG 22/S6

~~36,00€~~

21,90€

JOGO DE CHAVES PARA PARAFUSOS DE PERFIL DE FENDA E PHILLIPS

Conteúdo: 3x75, 4x100, 5.5x100, PH0x60, PH1x80, PH2x100



FG 22/S8

~~51,00€~~

27,90€

JOGO DE CHAVES PARA PARAFUSOS DE PERFIL DE FENDA E PHILLIPS

Conteúdo: 3x75, 4x100, 5.5x100, 6.5x30, PH0x60, PH1x80, PH2x100, PH2x30



FG 22/S8B

~~58,00€~~

31,90€

JOGO DE CHAVES PARA PARAFUSOS DE PERFIL DE FENDA E PHILLIPS

Conteúdo: 2.5x75, 3.5x100, 4x100, 6.5x150, 8x150, PH0x60, PH1x80, PH2x150



FG 22/S12

~~90,00€~~

49,90€

JOGO DE CHAVES PARA PARAFUSOS DE PERFIL DE FENDA E PHILLIPS

Conteúdo: 2.5x60, 3x75, 4x100, 5.5x150, 6.5x150, 8x150, 4x30, PH0x60, PH1x80, PH2x100, PH3x150, PH1x30





**FG 22TX/S6**

~~70,00€~~

**36,90€**

**JOGO CHAVES DE FENDA PARA PARAFUSOS DE PERFIL TORX**

Conteúdo: TX10, TX15, TX20, TX25, TX27, TX30



**FG 22RTX/S8**

~~94,50€~~

**49,90€**

**JOGO CHAVES DE FENDA PARA PARAFUSOS DE PERFIL TAMPER RESISTANT TORX**

Conteúdo: RTX10, RTX15, RTX20, RTX25, RTX27, RTX30, RTX40, RTX45



**FG 22FX/S10**

~~149,00€~~

**89,90€**

**JOGO CHAVES DE CAIXA COM HASTE RÍGIDA**

Conteúdo 5, 5.5, 6, 7, 8, 9, 10, 11, 12, 13 mm



**FG 139/B**

~~16,50€~~

**9,90€**

**JOGO 10 CHAVES MACHO HEXAGONAIS – SÉRIE CURTA**

Conteúdo: 1.5, 2, 2.5, 3, 4, 5, 5.5, 6, 8, 10 mm



**FG 139**

~~36,00€~~

**22,90€**

**JOGO 12 CHAVES MACHOS HEXAGONAIS COM EXTREMIDADE ESFÉRICA – SÉRIE CORTA**

Conteúdo: 1.5, 2, 2.5, 3, 4, 4.5, 5, 5.5, 6, 7, 8, 10 mm



CABEÇA DE BOLA

**FG 139/C**

~~24,50€~~

**13,90€**

**JOGO 10 CHAVES MACHO HEXAGONAIS – SÉRIE LONGA**

Conteúdo: 1.5, 2, 2.5, 3, 4, 5, 5.5, 6, 8, 10 mm



**FG 139/L**

~~41,50€~~

**24,90€**

**JOGO 12 CHAVES MACHOS HEXAGONAIS COM EXTREMIDADE ESFÉRICA – SÉRIE LONGA**

Conteúdo: 1.5, 2, 2.5, 3, 4, 4.5, 5, 5.5, 6, 7, 8, 10 mm



CABEÇA DE BOLA

**FG 139/LM**

~~54,00€~~

**32,90€**

**JOGO 10 CHAVES MACHO HEXAGONAIS COM IMPRONTA ESAGONALE SFERICA**

Conteúdo: 1.5, 2, 2.5, 3, 4, 5, 6, 7, 8, 10 mm



Extremo magnético

**FG 139/IN**

~~38,00€~~

**22,90€**

**JOGO 13 CHAVES MACHO HEXAGONAIS COM EXTREMIDADE ESFÉRICA – SÉRIE EM POLEGADAS**

Conteúdo: 0.05 - 3/8"



CABEÇA DE BOLA





**FG 85/175-S9**

~~106,00€~~

**65,00€**

**JOGO DE 8 CHAVES DE FENDAS BIVALENTES E 1 PUNHO**

Conteúdo: FG 85/175FPH0, PH1, PH2 - G 85/175T6-8, T7-9, T10-15, T20-25, T30-40 - FG 85/IM



**NEW**



**FG 85/175-S10**

~~115,00€~~

**69,00€**

**JOGO DE 9 CHAVES DE FENDAS BIVALENTES E 1 PUNHO**

Conteúdo: FG 85/175FPH0, PH1, PH2 - FG 85/175PZ1-2 - FG 85/175H2.5 - H3,H4,H5,H6 - FG 85/IM



**NEW**



**FG 59XT/S3**

~~89,50€~~

**49,90€**

**JOGO 3 ALICATES**

Conteúdo: FG 59/XT180, FG 63/XT160, FG 61/XT160

**FG 59XT/S3B**

~~99,50€~~

**59,90€**

**JOGO 3 ALICATES**

Conteúdo: FG 63/H180, FG 61/XT200, FG 59/XT180



**FG 58/C250**

~~43,00€~~

**26,90€**

**ALICATE AJUSTÁVEL COM CHARNEIRA SOBREPOSTA E LIBERTAÇÃO RÁPIDA**

mm - polegares: 250 - 10"

HRC: 54-58

**NEW**



**SISTEMA DESLIZANTE RÁPIDO SEM BOTÃO**

**FG 51/S4**

~~105,00€~~

**59,90€**

**JOGO 4 ALICATES DE FREIOS INTERIORES, COM PUNTAS REFORÇADAS DE AÇO 10-25MM**

Conteúdo: FG 51/140, FG 52/140, FG 53/140, FG 54/140

**FG 51/S4B**

~~112,00€~~

**62,90€**

**JOGO 4 ALICATES DE FREIOS INTERIORES, COM PUNTAS REFORÇADAS DE AÇO 19-60MM**

Conteúdo: FG 51/180, FG 52/180, FG 53/180, FG 54/180



**FG 55/S4**

~~140,00€~~

**79,90€**

**JOGO DE 4 ALICATES DE FREIOS INTERIORES, COM PUNTAS REFORÇADAS DE AÇO 10-25MM**

Conteúdo: FG 55/140, FG 56/140, FG 57/140, FG 58/140

**FG 55/S4B**

~~145,00€~~

**82,90€**

**JOGO DE 4 ALICATES DE FREIOS INTERIORES, COM PUNTAS REFORÇADAS DE AÇO 19-60MM**

Conteúdo: FG 55/180, FG 56/180, FG 57/180, FG 58/180

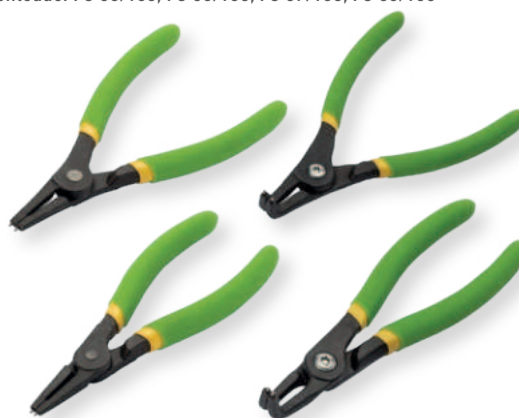

Insertos reforçados para excelentes anéis de vedação





# ELETRÓNICA E ELETROTÉCNICA

FG 22E/S6

~~58,00€~~

34,90€

**JOGO 6 CHAVES PARA PARAFUSOS**

Conteúdo: 3X100, 4X100, 5.5X125, PH0x60, PH1x80, PH2x100



FG 22E/SZ6

~~58,00€~~

34,90€

**JOGO 6 CHAVES PARA PARAFUSOS**

Conteúdo: 3X100, 4X100, 5.5X125, PZ0x60, PZ1x80, PZ2x100



FG 59IS/S3

~~120,00€~~

64,90€

**JOGO 3 ALICATEIS ISOLADAS**

Conteúdo: FG 59/IS180, FG 61/IS200, FG 63/IS160



FG 536/1-IS

~~700,00€~~

439,00€

**CHAVE DINAMOMÉTRICA ISOLADA DE 1/2" PARA DESLIGAR E BLOQUEAR**

Adequado para trabalhos com tensão inferior a 1000V AC (corrente alternada) e inferior a 1500V DC (corrente contínua)

Lado esquerdo

Em conformidade com a norma IEC 60900 de 1000V

Em conformidade com as normas DIN ISO 6789



NEW



FG 68U/S439

~~298,00€~~

169,00€

**JOGO DE ALICATE COM MATRIZ INTERCAMBIÁVEL**

+ 3 MATRIZ (FG 68/MAT4, FG 68/MAT16, FG 68/MAG), + 435 TERMINAIS ISOLADOS



FG 96/DG

195,00€

119,00€



**MULTÍMETRO DIGITAL DC/AC - OHM**

Classe II  
 Categoria de sobretensão: CAT III 300V  
 Teste de continuidade  
 Freqüência: 10Hz-200kHz  
 Teste de díodos  
 Ciclo de trabalho 5%-95% RH (± 0,1%)  
 Temperatura - 20°C/400°C (± 1,5% ± 3,0°C) / 400°C/1000°C (± 2,0% ± 3,0°C)  
 Medição de lux 4.000 lux (± 1) / 40.000 lux (± 10)  
 Capacidade de detecção de humidade 30%-90% HR (± 0,1%)  
 Capacidade de detecção de som 35 - 100dB (± 0,1dB)  
 Modo de espera após 15 minutos  
 Indicador do nível da pilha  
 Bateria de 9 V



DC	AC	Ω	DIMENSIONES MM
400mV-300V	4V-300V	400Ω-40MΩ	165x80x35

FG 98/DG

340,00€

199,00€



**MULTÍMETRO DIGITAL**

Classe II  
 Categoria de sobretensão: CAT IV 600V;  
 CAT III 1000V  
 Freqüência: 100 kHz  
 Teste de díodos  
 Fonte de alimentação: 1 x bateria de 9V



DC	AC	Ω	DIMENSIONES MM
200mV-1000V	2V-750V	200Ω-20MΩ	184x90x46

FG 97/DG

135,00€

79,00€



**MULTÍMETRO DIGITAL SMART**

Classe II  
 Categoria de sobretensão: CAT III 600V  
 Teste de díodos  
 Fonte de alimentação: 1 pilha AAA de 1,5V



DC	AC	Ω	DIMENSIONES MM
600mV-600V	6V-600V	600Ω-60MΩ	148x76x21

FG 99/DG

250,00€

149,00€



**PIÇA DE CORRENTE**

Classe II  
 Categoria de sobretensão: CAT III 600V  
 Temperatura: -20°C a 1000°C (-4°F a 1832°F)  
 Freqüência: 10Hz; 100Hz; 1000Hz; 10kHz; 100kHz; 1000kHz; 10MHz  
 Teste de díodos  
 Fonte de alimentação: 3 pilhas de 1,5V TIPO AAA



DC	AC	Ω	DIMENSIONES MM
600mV-600V	6V-600V	600Ω-60MΩ	194x59x29





## CHAVES DINAMOMÉTRICAS

### PONTA PARA PARAFUSOS DE PERFIL TORX

Precisão  $\pm 4\%$

Fornecido com certificado de calibração



CÓDIGO	RISOLUZIONE NM	ATTACCO	NM	€/LISTINO	€/PROMO
FG 531	0.1	1/4"	5-25	215,00€	132,00€
FG 533/2	0.25	3/8"	10-50	240,00€	142,00€
FG 536/1	0.5	1/2"	20-100	240,00€	145,00€
FG 536/2	1.0	1/2"	40-200	250,00€	149,00€
FG 536/3	2.0	1/2"	60-340	285,00€	169,00€
FG 540/1	2.5	3/4"	150-750	1.050,00€	629,00€
FG 540/2	2.5	3/4"	200-1000	1.200,00€	719,00€

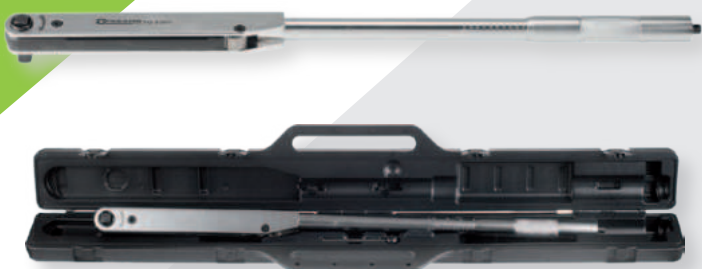

### BARRA DINAMOMÉTRICAS PARA APERTO DIREITO E ESQUERDO - 3/4"

Precisão  $\pm 4\%$ .

Fornecido com certificado de calibração

Fornecido em caixa ABS

CÓDIGO	NM	ATTACCO QUADRO	€/LISTINO	€/PROMO
FG 538/1	140-560	3/4"	800,00€	499,00€
FG 538/2	200-800	3/4"	880,00€	559,00€
FG 539/1	200-1000	1"	1.150,00€	699,00€



**CHAVES DINAMOMÉTRICAS DIGITAL DE ROQUETE REVERSÍVEL EM NM E GRAUS - 1/2"**



Precisão:  $\pm 4\%$   
 Mão Direita e Esquerda  
 Duplo modo de medição: PEAK e TRACK  
 Som de 12 LED e indicador visual a realização do torque predeterminado  
 Possibilidade de memorizar até 250 rascunhos diferentes graças ao software para PC incluído no kit  
 Interface de PC via USB  
 Capacidade de configurar até 9 rascunhos pré-definidos  
 Fonte de alimentação: 2 baterias de 1,5V (incluídas)

CÓDIGO	NM	€/LISTINO	€/PROMO
FG 543/DG1	6.8-135	675,00€	399,00€
FG 543/DG2	10-200	790,00€	469,00€



**FG 546/DG** ~~330,00€~~ **199,00€**

**CHAVES DE APERTO ANGULAR DIGITAL EM NM E GRAUS**



Precisão:  $\pm 2\%$   
 Mão Direita e Esquerda  
 Duplo modo de medição: PEAK e TRACK  
 Som de 6 LED e indicador visual a realização do torque predeterminado  
 Possibilidade de memorizar até 50 rascunhos diferentes  
 Fonte de alimentação: 2 baterias de 1,5V (incluídas)



**FG 547/DG** ~~210,00€~~ **125,00€**

**CHAVES DE APERTO ANGULAR DIGITAL EM NM**

Precisão:  $\pm 2\%$   
 Mão Direita e Esquerda  
 Som de 6 LED e indicador visual a realização do torque predeterminado  
 Equipado com um suporte magnético



**CHAVE DE FENDAS DE BINÁRIO LIVREMENTE AJUSTÁVEL**



Precisão de aperto  $\pm 6\%$ .

CÓDIGO	NM	L/MM	€/LISTINO	€/PROMO
FG 559/1	0.1-1.2	155	220,00€	129,00€
FG 559/2	1-6	155	230,00€	139,00€



**CHAVE DE FENDAS DE BINÁRIO LIVREMENTE AJUSTÁVEL**

CÓDIGO	NM	RAPPORTO	€/LISTINO	€/PROMO
FG 581/A	231-1.500	1:6.5	850,00€	499,00€
FG 581/B	208-2.500	1:12	1.320,00€	799,00€





## FERRAMENTAS DE CORTE

**FG 70/S110**

~~350,00€~~

**199,00€**

**JOGO DE 110 MACHOS E CAÇONETOS EM AÇO AO CRÓMIO E ACESSÓRIOS**

Roscas métricas de passo grosso e fino



						ACCESÓRIOS
2x.04	6x0.75	12x1	2x0.4	6x0.75	12x1	GF25x9
3x0.5	7x0.75	12x1.25	3x0.5	7x0.75	12x1.25	GF8x14
4x0.7	8x0.75	12x1.5	4x0.7	8x0.75	12x1.5	GMM1.5
5x0.8	8x1	14x1	5x0.8	8x1	14x1	GMM3
6x1	9x0.75	14x1.25	6x1	9x0.75	14x1.25	GMC1
7x1	9x1	14x1.5	7x1	9x1	14x1.5	
8x1.25	10x0.75	16x1	8x1.25	10x0.75	16x1	
9x1.25	10x1	16x1.5	9x1.25	10x1	16x1.5	
10x1.5	10x1.25	18x1.5	10x1.5	10x1.25	18x1.5	
11x1.5	11x0.75		11x1.5	11x0.75		
12x1.75	11x1		12x1.75	11x1		
14x2	11x1.25		14x2	11x1.25		
16x2	12x0.75		16x2	12x0.75		

**FG 75TIN/S25**

~~240,00€~~

**139,00€**

**JOGO BROCAS RECTIFICADAS EM HSS-TIN 5%**

Conteúdo: 1-13x0,5mm



**FG 75CO/S25**

~~248,00€~~

**149,00€**

**JOGO BROCAS RECTIFICADAS EM HSS-COBALT 5%**

Conteúdo: 1-13x0,5mm





FG 49/L

~~19,00€~~

11,90€

**TESOURA COM LÂMINA EM AÇO INOXIDÁVEL**

L/mm 200  
Abertura máxima 151 mm  
HRC: 52-54



FG 77/TT

~~9,90€~~

5,90€

**CORTA TUBOS COM LÂMINA EM AÇO INOXIDÁVEL**

L/mm: 226  
Capacidade: 3-36mm  
HRC: 48-52  
Para tubos de borracha



FG 49/MU

~~28,00€~~

17,90€

**TESOURA COM LÂMINAS DIREITAS EM AÇO INOXIDÁVEL, COM MICRO-DIENTES**

HRC: 52-54



**TESOURA MODELO AMERICANO COM LÂMINAS LARGAS E DIREITAS**

HRC: 58-61



CÓDIGO	L/MM	ACCIAIO	INOX	€/LISTA	€/PROMO
FG 49/HE200	200	0.53mm	0.36mm	22,00€	13,90€
FG 49/HE250	250	0.78mm	0.46mm	27,00€	16,90€
FG 49/HE300	300	0.94mm	0.78mm	35,00€	21,90€
FG 49/HE350	350	1.24mm	0.78mm	40,00€	24,90€

FG 49/TC

~~44,00€~~

27,90€

**TESOURA PARA ELECTRICISTA, COM ENTALHE PARA DESCARNAR CABO Y CORPO INTEIRAMENTE EM AÇO**

L/mm 140 - H/mm 65  
Lâmina de aço micro serrilhada  
HRC: 56  
Construção integral em aço inoxidável  
Cortador de cabos 12mm  
Com suporte para cinto



Suporte de cinto ABS



Construção totalmente em aço forjado

FG 49/TCX

~~62,00€~~

34,90€

**TESOURA PARA ELECTRICISTA, COM ENTALHE PARA DESCARNAR CABO Y CORPO INTEIRAMENTE EM AÇO**

L/mm 160 - A/mm 50  
Lâmina de aço micro-serrilhada  
HRC: 56  
Estrutura integral de aço inoxidável  
Cortador de cabo de 15 mm  
Com suporte de correia



Construção totalmente em aço forjado



Suporte de cinto ABS

FG 49/CF

~~32,00€~~

17,90€

**TESOURA PARA ELECTRICISTA COM FERRAMENTA DE ENGASTE PARA TERMINAIS DE TUBOS**

L/mm 155 - A/mm 45  
Com entalhe para descarnar cabo e ferramenta de engaste para terminais de tubos  
Lâmina de aço - HRC 52-54  
Capacidade do cortador de cabos 12mm

NEW



FG 77/PVC4

~~50,00€~~

31,90€

**TESOURA COM ROQUETE**

Sistema de cremalheira com avanço progressivo  
Equipada com plataforma de nylon para facilitar o corte de perfis planos  
Para tubos de PVC  
Ømm: 0-42





# MANUTENÇÃO GERAL

**FITAS MÉTRICAS, REVESTIMENTO ABS DE 2 COMPONENTES RESISTENTE AO CHOQUE, FITA EM AÇO**

Classe II



CÓDIGO	L/MT	BANDA MM	€/LISTA	€/PROMO
FG 44/MT3	3	16	11,50€	6,90€
FG 44/MT5	5	25	19,00€	11,90€
FG 44/MT8	8	25	24,00€	13,90€
FG 44/MT10	10	25	29,00€	16,90€

**FG 95/CA**

~~52,00€~~

**29,90€**

**PAQUÍMETRO LEITURA CINQUAGESIMAL**

Escada cromada  
Haste fina  
Fecho de parafuso  
Aço inoxidável endurecido  
L/mm: 150

**FG 95/CA2**

~~125,00€~~

**74,90€**

**PAQUÍMETRO EM AÇO INOXIDÁVEL LEITURA CINQUAGESIMAL**

Escada cromada  
Haste fina  
Fecho de parafuso  
Aço inoxidável endurecido  
L/mm: 200



**FG 95/DG**

~~96,00€~~

**56,90€**

**PAQUÍMETRO DIGITAL LEITURA CENTESIMAL**

L/mm: 150



**FG 96/CA**

~~55,00€~~

**32,90€**

**PAQUÍMETRO LEITURA VIGESIMAL**

L/mm: 150

**NEW**

**FG 96/CA2**

~~130,00€~~

**69,00€**

**PAQUÍMETRO LEITURA VIGESIMAL**

L/mm: 200

**NEW**



FG 127/S1

~~49,50€~~

29,90€

JOGO 6 FERRAMENTAS DE PERCUSSÃO



FG 128C/S6

~~46,50€~~

27,90€

JOGO DE 6 SACA-TROÇOS

Medições: 2, 3, 4, 5, 6, 8mm



FG 712/L4

~~120,00€~~

49,00€

RECIPIENTE DE PEÇAS PEQUENAS COM COMPARTIMENTOS GIRATÓRIOS

Fornecido com divisórias interiores  
Equipado com 4 prateleiras giratórias e tabuleiro superior para utensílios  
Material: ABS resistente ao impacto  
Equipado com 4 pés de apoio



FG 712/A

~~50,00€~~

19,90€

PORTA-FERRAMENTAS/PEÇAS PEQUENAS EQUIPADO COM RODAS GIRATÓRIAS

2 compartimentos magnéticos para peças pequenas  
2 compartimentos grandes para ferramentas  
Equipado com placa central magnética  
3 rodízios giratórios de 50 mm  
Material: ABS resistente a impactos



FG 92/PM

~~19,50€~~

11,90€

EXTENSÃO MAGNÉTICA FLEXÍVEL

Haste de 1 metro  
Pega de borracha antiderrapante



FG 92/GR

~~27,00€~~

15,90€

EXTENSÃO MAGNÉTICA FLEXÍVEL

Capacidade 1 kg  
L/mm 700  
Equipado com mandíbulas de preensão



Com garras preñseis

FG 92/PM4

~~27,50€~~

13,90€

EXTENSÃO MAGNÉTICA TELESCÓPICA

L/mm 165-622  
Pega em PVC antiderrapante  
Capacità 2,3 kg



FG 92/PF

~~27,50€~~

14,90€

EXTENSÃO MAGNÉTICA ARTICULADA

Capacidade 3,5 kg  
L/mm haste 400  
Ø/mm 1,5  
Ponta magnética







FG 98/GAS

130,00€

79,00€

**SOLDADOR A GÁS PORTÁTIL**

Temperatura máxima: 210-450 °C  
25 watts  
Autonomia 120 minutos  
Fornecido com pontas para soldar, cortar e soprar  
Fornecido em caixa ABS



FG 98/LT

186,00€

119,00€

**FERRO DE SOLDAR RECARREGÁVEL COM BATERIAS DE LÍTIO**

Temperatura máxima: 600 °C  
Autonomia 40 minutos  
Tempo de carregamento 3,5h  
Fornecido com pontas para soldar, cortar e soprar  
Fornecido em caixa ABS



FG 96/SS36

65,00€

39,90€

**SOLDADOR DE PALHETAS DE DUPLA POTÊNCIA**

Classe de proteção I  
30/60 Watt - 230V - Ø/mm 5.8



FG 494/S12

55,00€

33,90€

**PISTOLA DE COLA QUENTE**

Potência de aquecimento nominal 80W  
Temperatura de funcionamento: 193°C (383 °F)  
Tempo de aquecimento: 3/5 minutos  
Comprimento do bastão de cola: 200mm  
Diâmetro do bastão de cola: 11,5 mm  
Fornecido em caixa ABS com 12 bastões de cola incluídos



FG 96/SS30

48,00€

29,90€

**SOLDADOR**

Classe de proteção I  
30 Watt - 230V - Ø/mm 4 - 430 °C



FG 494/A180

175,00€

109,00€

**PISTOLA DE COLA QUENTE**

Potência nominal de aquecimento 180W  
Temperatura de funcionamento 193°C  
Tempo de aquecimento 3/5 minutos  
L/mm stick cola 100/250/350  
Stick cola Ø/mm 11/11,5  
Equipado com um pé de apoio para evitar que a ponta aquecida toque na superfície da bancada  
Fornecido com 1 bocal de substituição



FG 96/SS60

60,00€

36,00€

**SOLDADOR**

Classe de proteção I  
60 Watt - 230V - Ø/mm 6 - 500 °C



TORNO DE BANCADA PARALELO EM AÇO FORJADO

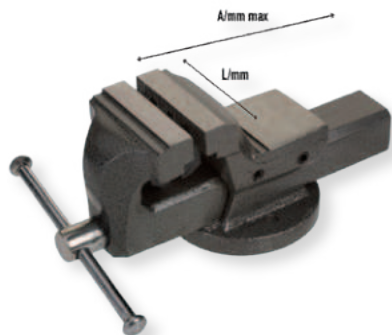

CÓDIGO	L/MM	A/MM	€/LISTA	€/PROMO
FG 121/B125	125	150	300,00€	179,00€
FG 121/B150	150	200	380,00€	229,00€
FG 121/B200	200	220	560,00€	339,00€

FG 125/S3

~~68,00€~~

41,90€

JOGO DE 3 ALAVANCAS

Conteúdo: 300, 450, 600 mm



FG 93/M50

~~30,00€~~

17,90€

ESPELHO DE AÇO TELESCÓPICO E ARTICULADO

Ø/mm espelho 50

L/mm haste 240-698



FG 93/M95

~~30,00€~~

17,90€

ESPELHO DE AÇO TELESCÓPICO E ARTICULADO

Dimensões do espelho mm 50x95

L/mm haste 370-775



FG 493/AL

~~46,00€~~

28,90€

PISTOLA DE SELAGEM COM TUBO DE ALUMÍNIO

L/mm 240

Equipado com sistema anti-gotejamento

Capacidade 300cc



FG 493/N

~~39,00€~~

23,90€

PISTOLA DE SELAGEM COM TUBO DE AÇO

Corpo principal e mecanismo interno totalmente em aço

Capacidade 300cc



MARTELOS PARA MECÂNICO COM CABO DE RESINA



CÓDIGO	GR	L/MM	€/LISTA	€/PROMO
FG 132/200	200	294	19,00€	11,90€
FG 132/300	300	297	20,50€	12,90€
FG 132/500	500	312	22,00€	13,90€
FG 132/800	800	342	28,00€	17,90€
FG 132/1000	1.000	343	30,00€	18,90€

MAÇO COM PUNHO EM MADEIRA E COLAR DE PROTEÇÃO CABO



CÓDIGO	GR	L/MM	€/LISTA	€/PROMO
FG 134/H800	800	260	22,00€	13,90€
FG 134/H1000	1.000	262	23,50€	14,90€
FG 134/H1250	1.250	262	25,50€	15,90€
FG 134/H1500	1.500	280	30,00€	18,90€
FG 134/H2000	2.000	300	36,00€	22,90€



**FG 1450**

~~132,00€~~

**83,90€**

## BOLSA DE FERRAMENTAS DE TECIDO TECNICO 600D

Tecido técnico de alta resistência  
 Base semi-rígida com rebordos de plástico  
 Grande compartimento central  
 Vários bolsos interiores e exteriores  
 Bolso traseiro fechado e bolso frontal duplo fechado com presilhas  
 Alça de ombro almofadada ajustável



BOLSO FECHADO NAS COSTAS

BASE SEMI-RÍGIDA

VÁRIOS BOLSOS INTERNOS



**FG 1452**

~~140,00€~~

**89,00€**

## CESTA DE FERRAMENTAS DE TECIDO TECNICO 600D COM TAMPA

Estrutura rígida em tecido técnico de alta resistência  
 Base de plástico rígido para proteção do conteúdo  
 Grande compartimento aberto para um acesso fácil ao conteúdo  
 Tampa com fecho de velcro  
 Pega metálica com punho de borracha macia  
 Vários bolsos e presilhas interiores e exteriores  
 Bolso lateral fechado e bolso frontal para serra  
 Alça de ombro almofadada ajustável



GRANDE COMPARTIMENTO CENTRAL VÁRIOS BOLSOS ABERTO

TAMPA DE FECHO COM VELCRO OCULTO



**FG 1454**

~~186,00€~~

**119,00€**

## BOLSA DE FERRAMENTAS DE TECIDO TECNICO 600D

Estrutura rígida em tecido técnico de alta resistência  
 Base de plástico rígido para proteção do conteúdo  
 Dois grandes compartimentos separados  
 Vários bolsos e presilhas interiores e exteriores  
 Bolsos fechados nas costas e na frente  
 Pega confortável e alça de ombro almofadada ajustável



BOLSO FECHADO NAS COSTAS

VÁRIOS BOLSOS INTERNOS





FG 1456

235,00€

149,00€

**CARRINHO DE FERRAMENTAS PARA TECIDO TECNICO 600D**

Tecido técnico de alta resistência  
Pega telescópica e 2 rodas robustas para um transporte fácil  
Construção rígida com grande compartimento interior para guardar ferramentas eléctricas, ferramentas manuais e acessórios  
Bolsos interiores e exteriores para uma organização óptima do espaço  
2 bolsos exteriores fechados à frente



TECIDO TÉCNICO DE ALTA RESISTÊNCIA

GRANDE COMPARTIMENTO INTERNO

2 RODAS PARA TRANSPORTE



FG 1460

150,00€

89,00€

**MOCHILA DE FERRAMENTAS EM TECIDO TECNICO 600D**

Tecido técnico de alta resistência  
Base de plástico rígido para proteção do conteúdo  
Compartimento interno duplo, compartimento para ferramentas e compartimento para computador portátil e documentos  
Vários bolsos laterais e frontais, interiores e exteriores  
Encosto ergonómico almofadado  
Alças acolchoadas para os ombros e alça ajustável para o peito



ALÇAS ACOLCHOADAS

COMPARTIMENTO INTERNO DUPLO COM SUPORTE PARA PC

BASE DE PLÁSTICO RÍGIDO



FG 1465

200,00€

119,00€

**MOCHILA DE FERRAMENTAS DE TECIDO TECNICO 600D COM RODAS E SISTEMA TROLLEY**

Dimensões da bagagem de mão  
Tecido técnico de alta resistência  
Pega telescópica retrátil  
Rodas integradas com tampa rebatível  
Compartimento interior duplo, compartimento para ferramentas e compartimento para computador portátil e documentos  
Vários bolsos laterais e frontais, interiores e exteriores  
Encosto ergonómico almofadado  
Alças de ombro almofadadas e alça peitoral ajustável e bloqueável



DIMENSÕES DA BAGAGEM DE MÃO

COMPARTIMENTO INTERNO DUPLO

CAPA DE RODA DOBRÁVEL





**FG 113/A**

~~198,00€~~

**119,00€**

### CAIXA DE FERRAMENTAS DE CHAPA METÁLICA

Equipado com pegas laterais rebatíveis  
Predisposição para cadeado  
Estrutura em chapa de aço 0,8 mm  
Dimensões 520x290x290 mm



**FG 113/B**

~~220,00€~~

**129,00€**

### CAIXA DE FERRAMENTAS DE CHAPA METÁLICA

Equipado com pegas laterais rebatíveis  
Predisposição para cadeado  
Estrutura em chapa de aço 0,8 mm  
Dimensões 650x350x350 mm



**FG 113/C**

~~260,00€~~

**149,00€**

### CAIXA DE FERRAMENTAS DE CHAPA METÁLICA

Equipado com pegas laterais rebatíveis  
Predisposição para cadeado  
Estrutura em chapa de aço 0,8 mm  
Dimensões 850x350x350 mm



**FG 113/D**

~~320,00€~~

**189,00€**

### CAIXA DE FERRAMENTAS DE CHAPA METÁLICA

Equipado com pegas laterais rebatíveis  
Predisposição para cadeado  
Estrutura em chapa de aço 0,8 mm  
Dimensões 1000x400x450 mm



**FG 111/AS104**

~~863,50€~~

**329,00€**

### CAIXA EXTENSÍVEL COM 5 DIVISÕES E SORTIDO DE 104 FERRAMENTAS



**FG 111/A**

~~62,00€~~

**32,90€**

### CAIXA EXTENSÍVEL COM 3 DIVISÕES EM CHAPA METÁLICA

Previsão para cadeado  
Divisória do compartimento superior  
Estrutura em chapa metálica  
Dimensões 430x200x160 mm



### CAIXA EXTENSÍVEL COM 5 DIVISÕES EM CHAPA METÁLICA

Previsão para cadeado  
Divisória do compartimento superior  
Estrutura em chapa metálica



CÓDIGO	DIMENSIONI MM	€/LISTA	€/PROMO
FG 111/B	430x200x200	75,00€	39,90€
FG 111/C	530x200x200	94,00€	49,90€

**UMA AMPLA GAMA DE SOLUÇÕES  
PARA ILUMINAR O SEU TRABALHO!**

Uma proposta completa, com inúmeros modelos funcionais e de alto desempenho, ideais para iluminar a área de trabalho durante as operações de inspeção, manutenção e reparação.

**COMPACTE**

FG 203 - FG 204 - FG 213/L480

**SUBTIL**

FG 211 - FG 212 - FG 207 - FG 207/B - FG 206

**TOCHAS**

FG 214/L600 - FG 201

**SEM FIO**

FG 210/W - FG 213/DP - FG 213/W - FG 213/S3

**LUZES DE  
TRABALHO**

FG 221 - FG 224/L5200 - FG 222/B - FG 217/B - FG 210/C

**CONTROLAR  
COR**

FG 234 - FG 235 - FG 236

**SOB O  
CAPÔ**

FG 209 - FG 210/B

**MULTIFUNÇÕES**

FG 202 - FG 222/A - FG 205/B





# ILUMINAÇÃO

FG 203

~~22,80€~~

12,90€

MAX 100 LUMEN

0.5h

MAX 3h

## MINI PROJETOR PORTÁTIL LED

Equipado com ímanes traseiros, função de gestão da intensidade, porta de carregamento dupla. Cabo de carregamento USB incluído. Corpo em alumínio anodizado. Função de regulação da intensidade. Dimensões 28,4x32 mm



PORTAS DE CARREGAMENTO DUPLAS TIPO C E MICRO USB



BASE MAGNÉTICA



CE

FG 204

~~32,50€~~

19,90€

MAX 300 LUMEN

LI-10N BATTERY

2.5h

MAX 3h

## MINI LÂMPADA LED PORTÁTIL

Bateria de lítio de longa duração. Dimensões 21x89 mm



EQUIPADO COM BASE MAGNÉTICA



CE

FG 213/L480

~~65,00€~~

39,90€

MAX 480 LUMEN

2.5h

MAX 10h

## LÂMPADA DUPLA LED COM SENSOR ON/OFF SEM CONTATO

Com sensor on/off sem contacto. 4 níveis de inclinação. Indicador do estado de carga. 4 ímanes traseiros para utilização sem banda elástica. Cabo USB tipo C incluído. Dimensões 67x34



EQUIPADO COM 4 ÍMANES TRASEIROS PARA UTILIZAÇÃO SEM ELÁSTICO



4 NÍVEIS DE INCLINAÇÃO



SENSOR DE LIGAR/DESLIGAR SEM TOQUE



CE

FG 211

110,00€

59,90€

LÂMPADA LED RECARREGÁVEL

MAX 600 LUMEN

CE



385mm



LED superior apontando



Rotação de 360



Base magnética gancho removível

FG 207

65,00€

37,90€

LÂMPADA LED RECARREGÁVEL

Led de ponta superior  
180° pivotante  
Base magnética  
Indicador do estado de carga  
Classificação IP54 de resistência à água e ao pó  
Cabo USB tipo C incluído  
H/mm 300

MAX 300 LUMEN

CE



300mm



FG 212

78,00€

42,90€

LÂMPADA LED RECARREGÁVEL

MAX 200 LUMEN



174mm



Rotação de 360

FG 207/B

98,00€

59,90€

LÂMPADA LED RECARREGÁVEL

Led de topo  
Pivotante e rotativo a 180  
3 níveis de indicação de autonomia restante  
Base magnética  
Gancho amovível integrado na base  
Grau de resistência à água e ao pó IP54  
Grau de resistência ao impacto IK07  
Cabo USB tipo C incluído  
Dimensões 66x400 mm

MAX 700 LUMEN



400mm



Giratório até 180°



Seletor de brilho 60-700 lúmens



Giratório até 180°



**FG 206**

~~56,00€~~

**33,90€**

## LÂMPADA LED RECARREGÁVEL

Design fino  
Ímanes na parte de trás  
Gancho para pendurar a lâmpada  
Grau de proteção IPX4  
Cabo micro USB incluído  
Dimensões 10x249



**MAX 360 LUMEN**

CE



Gancho superior



Extra plano

**FG 201**

~~50,00€~~

**29,90€**

## LANTERNA MAGNÉTICA RECARREGÁVEL PARA TELESCÓPIO

Luminosidade 100/30 lúmenes  
Autonomia  
- 2h (modo de alta intensidade)  
- 6h (modo de baixa intensidade)  
Tempo de recarga 2,5h  
LED indicador do estado de carga no botão ON/OFF  
Gancho lateral  
Vara telescópica extensível até 505 mm  
Cabo USB tipo C incluído  
Dimensões 21x18x178mm



**MAX 100 LUMEN**

NEW

CE



Gancho de cinto



Função pick-up  
-capacidade de ímanes de 1,2 kg



Varilla telescópica (máx. 505 mm)

**FG 214/L600**

~~85,00€~~

**39,90€**

## TOCHA LED RECARREGÁVEL

Cone de luz ajustável  
Indicador do estado de carregamento  
Base de carregamento incluída  
com montagem na parede e cabo USB



**MAX 600 LUMEN**

CE



Cone de luz ajustável



Placa de suporte de parede fornecida

**FG 202**

~~56,00€~~

**33,90€**

## LÂMPADA RECARREGÁVEL DE LED COM SISTEMA TSC

LED apontador superior  
TSC SYSTEM, tecnologia de desligamento automático em contacto com superfícies  
Corpo em alumínio anodizado  
Íman duplo, na base e no verso  
Gancho para cinto  
Cabo USB tipo C incluído  
Dimensões 46x115 mm



**MAX 1200 LUMEN**

CE



Gancho de cinto traseiro



LED a apontar para cima



**TECNOLOGIA  
DESLIGAR  
POR CONTACTO**





FG 222/A

120,00€

49,00€

**LÂMPADA DE LED RECARREGÁVEL COM ALTO-FALANTES SEM FIO**

Led apontador superior  
Altifalante duplo sem fios de 5 W  
Gancho com ímanes integrados, amovível e giratório a 180 para pendurar ou apoiar o candeeiro  
Classificação IP54 de resistência à água e ao pó  
Cabo USB tipo C incluído  
Dimensões 65x164 mm



MAX 500 LUMEN



Caso duplo 5W sem fios



Ponteiro LED com mais de 160 lúmens



FG 217/B

300,00€

169,00€

**LÂMPADA RECARREGÁVEL COM 3 LUZES LED**

Brilho 6000/3000/1500 lúmens  
Também pode ser utilizada ligada ao carregador com 500 lm de luminosidade  
Potente bateria de lítio de 7,3V - 8000mAh  
Autonomia:  
- 9h (modo de baixa intensidade)  
- 5h (modo de intensidade média)  
- 3h (modo de alta intensidade)  
Tempo de recarga: 10h  
3 luzes LED giratórias (180°) e rotativas (270°)  
4 LEDs que indicam o estado de carregamento  
Função Power Bank 5V 1A  
Base magnética com gancho amovível integrado  
Altura total de 1700 mm (incluindo a lâmpada)  
Saco de nylon incluído  
Cabo USB tipo C incluído  
Dimensões 90x90x205



3 ímanes en la base



As lâmpadas rotativas têm um ângulo de 270°

NEW



MAX 6000 LUMEN

FG 205/B

85,00€

49,90€

**LÂMPADA LED PORTÁTIL**

LED frontal com 600/200 lúmenes de luminosidade  
LED de mira superior com 200 lúmenes de luminosidade  
Autonomia do LED frontal  
- 3h (modo de alta intensidade)  
- 12h (modo de baixa intensidade)  
Autonomia do LED superior: 9h  
Tempo de recarga: 3h  
Gancho giratório amovível na parte de trás  
Base giratória de 180° com íman integrado  
4 LEDs que indicam o estado de carregamento  
Cabo USB tipo C incluído  
Dimensões 54x32x186



NEW

MAX 600 LUMEN



Um gancho amovível de 360°.



Base giratória de 180° com íman integrado.



TRIPÉ TELESCÓPICO ATÉ 1,70 M



**FG 210/C**

**165,00€**

**99,00€**

## REFLETOR DE TRABALHO DE LED RECARREGÁVEL

Função de banco de potência (saída USB máxima 5V 2A)  
 Suporte giratório de 180°  
 5 níveis de indicação da autonomia restante  
 Classificação IP65 de resistência à água e ao pó  
 Grau de resistência ao impacto IK07  
 Índice de restituição de cor CRI 70+  
 Cabo USB tipo C incluído  
 Dimensões 208x140 mm



CLASSIFICAÇÃO DE PROTEÇÃO IP65

**MAX 3000 LUMEN**



SUPOORTE AJUSTÁVEL DE 180°



FUNÇÃO DE BANCO DE POTÊNCIA

CE

**FG 221**

**340,00€**

**159,00€**

## LUZ DE TRABALHO DE FEIXE DUPLO

Rotação horizontal de 180° por luminária: ilumina eficazmente diferentes áreas do ambiente de trabalho  
 Corpo giratório de 90°  
 Bateria de lítio amovível de 14,8 V com função Power Bank (saída USB máx. 5 V 2 A)  
 5 níveis de indicação da vida útil restante da bateria  
 Carregador de bateria incluído  
 Dimensões 190x295 mm



BATERIA DE LÍTIO COM FUNÇÃO DE POWER BANK

**MAX 4500 LUMEN**



BATERIA REMOVÍVEL



ELEMENTOS DE ILUMINAÇÃO AJUSTÁVEIS ATÉ 180°

CE

**FG 224/L5200**

**250,00€**

**129,00€**

## LUZ DE CONSTRUÇÃO DE LED RECARREGÁVEL COM LENTE ANTIRREFLEXO

Lente opaca especial que reduz o encandeamento e aumenta a difusão da luz  
 Suporte giratório de 180° que pode ser ligado a um tripé  
 3 níveis de indicação da vida útil restante da bateria  
 Classificação IP65 de resistência à água e ao pó  
 Grau de resistência ao impacto IK07  
 Carregador de bateria incluído  
 Dimensões 273x205 mm



CLASSIFICAÇÃO DE PROTEÇÃO IP65

**MAX 5200 LUMEN**



AJUSTÁVEL ATÉ 180°



CE

**FG 224/SU**

**100,00€**

**49,00€**

## TRIPÉ DE LUZ DE CONSTRUÇÃO FG 224/L5200

Altura máxima 1,60 M



FG 222/B

~~350,00€~~

169,00€

MAX 4000 LUMEN

**LUZ DE TRABALHO DE LED RECARREGÁVEL COM ALTO-FALANTES SEM FIO**

Altifalante duplo sem fios de 10 W  
 Função de banco de potência (saída USB máxima 5V 1A)  
 Corpo giratório de 140  
 5 níveis de indicação da duração restante da bateria  
 Gancho removível e giratório integrado na base  
 Classificação IP65 de resistência à água e ao pó  
 Carregador de bateria incluído  
 Dimensões 210x210 mm



GANCHO INTEGRADO AMOVÍVEL E GIRATÓRIO



ALTIFALANTES SEM FIOS DE 10 W



CORPO GIRATÓRIO DE 140



FG 209

~~265,00€~~

149,00€

MAX 1200 LUMEN



**LÂMPADA RECARREGÁVEL LED COM LENTE TRANSPARENTE E SEMITRANSARENTE**



MODO BRILHANTE (1200 LM)



MODO CONFORTÁVEL (1100 LM)



MODO SUAVE (600 LM)



FG 210/B

~~85,00€~~

49,90€

MAX 1200 LUMEN



**LANTERNA LED DE TUBO PORTÁTIL**

Equipado com um projetor de luz superior  
 Base magnética  
 Modo de luz vermelha de emergência  
 Inclui cabo de carregamento USB tipo C  
 Função de regulação da intensidade da luz



HOLOFOTE DE 400 LÚMENS



CARREGADOR USB TIPO C



SISTEMA DE FIXAÇÃO MAGNÉTICA





SEM FIO



SISTEMA DE CARREGAMENTO INTELIGENTE

FG 210/W

~~75,00€~~

44,90€

MAX 670 LUMEN

NEW

PROJETOR LED PORTÁTIL

Luminosidade 670/350/120 lúmenes

Luz pontual 250 lúmenes

Autonomia

- 2,5h (modo de alta intensidade)

- 4,5h (modo de intensidade média)

- 10h (modo de baixa intensidade)

Autonomia do projetor LED: 4,5h

Recarregável em dois modos

- na base de carregamento sem fios (FG 213/DP não incluída) em 6h

- com o cabo USB tipo C fornecido em 4h

3 LEDs que indicam o estado de carregamento

Projetor ajustável a 210° com ímã integrado

Dimensões: 83x35x100 mm



FOCO DE LUZ/FOCO DE LUZ DIFUSO



LÂMPADA ORIENTÁVEL 210°

FG 213/DP

~~90,00€~~

56,90€

NEW

BASE DE CARREGAMENTO WIRELESS

Duas posições de carregamento simultâneo com acoplamento magnético para lâmpadas FG 210/W, FG 213/W e uma posição de 170 mm para smartphone.

Input: Máximo 10Wx2

Dimensões: 290x27x102 mm



3 ÍMANS FORTES NA PARTE TRASEIRA



SUPORTE AMOVÍVEL PARA SMARTPHONE COM CARREGAMENTO SEM FIOS

**FG 213/W**

~~99,00€~~

**62,90€**

**NEW**

**LÂMPADA LED RECARREGÁVEL**

LED frontal com 1000/500/250 lúmenes de luminosidade

LED de mira superior com 200 lúmenes de luminosidade

Autonomia do LED frontal

- 1,5h (modo de alta intensidade)

- 2,5h (modo de intensidade média)

- 5h (modo de baixa intensidade)

Autonomia do LED superior: 7h

Recarregável em dois modos

- na base de carregamento sem fios (FG 213/DP não incluída) em 6,5h

- com o cabo USB tipo C incluído em 4,5h

Revestimento antiderrapante em borracha

3 LEDs que indicam o estado de carregamento

2 ganchos giratórios amovíveis na parte de trás

3 ímãs na parte de trás + 1 na base

Lâmpada ajustável a 180°

Grau de proteção IP65

Dimensões: 53x38x260 mm



2 GANCHOS AMOVÍVEIS  
ROTAÇÃO DE 360°



BASE MAGNÉTICA ROTATIVA DE 180°



3 ÍMANS NA PARTE DE TRÁS



**MAX 1000 LUMEN**

**FG 213/S3**

~~264,00€~~

**165,90€**

**NEW**

**BASE DE CARREGAMENTO WIRELESS**

Base de carregamento wireless com lâmpada e projetor



**SUPORTE REMOVÍVEL  
PARA SMARTPHONE  
COM RECARGA  
SEM FIO**







# LÂMPADAS PARA CONTROLAR COR

## SETOR DE CARROÇARIAS



FG 234

105,00€

59,00€



### FAROL DE LED COM ALTO ÍNDICE DE REPRODUÇÃO DE CORES PARA CONTROLE DE CORES

Índice de restituição de cor elevado CRI 96+  
3 opções de temperatura de cor 2700K/4500K/6500K  
Cabo USB incluído  
Dimensões 50x50 mm

COB LED - cri 96+  
3 COLORI  
2700K 4500K 6500K



SENSOR ON/OFF SEM CONTACTO

4 NÍVEIS DE INCLINAÇÃO

FG 235

135,00€

79,00€

### LÂMPADA RECARREGÁVEL DE LED COM ALTO ÍNDICE DE REPRODUÇÃO DE CORES PARA CONTROLE DE CORES

Elevado índice de restituição de cor CRI 96+  
3 opções de temperatura de cor 2700K/4500K/6500K  
Classificação IP65 de resistência à água e ao pó  
Grau de resistência ao impacto IK07  
Base de carregamento de secretária com tomada USB + cabo USB incluído  
Dimensões 50x190 mm

COB LED - cri 96+  
3 COLORI  
2700K 4500K 6500K

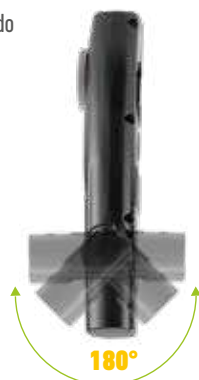

BASE MAGNÉTICA + SUPER ÍMAN NA PARTE DE TRÁS



LENTE SUBSTITUÍVEL



GANCHO EXTRAÍVEL





FG 236

335,00€

199,00€

**LUZ LED RECARREGÁVEL PARA CONTROLE DE CORES COM ALTO ÍNDICE DE REPRODUÇÃO DE CORES (CRI 96+)**

Elevado índice de restituição de cor CRI 96+

5 opções de temperatura de cor 2700K/3500K/4500K/5500K/6500K

Base giratória de 180

Função de memória dos parâmetros de última utilização

Classificação IP65 de resistência à água e ao pó

Grau de resistência ao impacto IK07

Acessório de tripé não incluído

Dimensões 115x190 mm



PAINEL DE CONTROLO



CARREGADOR DE LIBERTAÇÃO RÁPIDA COM CABO DE 5 M



2700K 3500K 4500K 5500K 6500K



FG 236/SU

100,00€

59,00€

**TRIPÉ PARA FAROL DE LED FG 236**

Altura 476 mm (fechado) - 1440 mm (aberto)

Número de extensões de pés 3

Carga máxima 2 kg

Peso líquido: 1098 gr



FG 225/SK1.5

300,00€

159,00€

**ENROLADOR DE CABO ELÉTRICO AUTOMÁTICO, 15M COM CABO 3GX1.5 MM<sup>2</sup>**

Comprimento do cabo de entrada 1,20 M

15m x 3G 1.5mm<sup>2</sup> 1000W

230V AC 2000W



LIMITADOR DE REENTRADA PARA DETENER LA CARRERA



SISTEMA DE BLOQUEIO EM QUALQUER COMPRIMENTO



FG 225/SK2.5

370,00€

179,00€

**ENROLADOR DE CABO ELÉTRICO AUTOMÁTICO, 15M COM CABO 3GX2.5 MM<sup>2</sup>**

Comprimento do cabo de entrada 1,20 M

15m x 3G 2.5mm<sup>2</sup> 1600W

230V AC 3200W



SUPORTE DE PAREDE AJUSTÁVEL A 360°



# POWER TOOLS

DESEMPENHO  
CONFIABILIDADE  
QUALIDADE

BRUSHLESS  
MOTOR



Descubra a nova linha de ferramentas elétricas Fasano Tools concebidas para satisfazer as necessidades do utilizador profissional. Duas linhas diferentes, com baterias de lítio com tensões de 14,4 V e 18 V respetivamente, desenvolvidas

para otimizar o desempenho das ferramentas, que tiram partido de tecnologias de última geração e estão equipadas com células de alta qualidade. Todas as novas ferramentas sem fios Fasano Tools estão equipadas com um motor sem escovas (brushless).

## DESEMPENHO

Os motores sem escovas desperdiçam menos energia, o que lhes permite fornecer mais potência com um desempenho ideal, mesmo em aplicações exigentes.

## EFICIÊNCIA

O motor sem escovas opera de forma mais eficiente, melhorando a autonomia das ferramentas durante a utilização e prolongando a vida útil da ferramenta ao longo do tempo.

## DESIGN COMPACTO

O design mais compacto do motor sem escovas torna as ferramentas mais leves e confortáveis de utilizar, mesmo nos contextos mais difíceis, onde o espaço é limitado, reduzindo a fadiga e melhorando a ergonomia.

FUNCIONALIDADE,  
COMPACTAÇÃO,  
VERSATILIDADE

Li-ion  
2Ah

A plataforma de 14,4 V é composta por 7 modelos, todos compatíveis com a mesma bateria de 14,4 V para uma grande versatilidade em diferentes situações de utilização.

Graças ao seu design compacto, estas ferramentas permitem-lhe trabalhar confortavelmente e o seu desempenho é adequado para completar o trabalho no menor tempo possível.

As ferramentas Fasano Tools 14,4 V disponíveis são: três roquetes com ligações de 1/2", 3/8", 1/4"; duas mini retificadoras com cabeças retas e angulares e duas lixadoras de cinta com cintas de diferentes tamanhos.

FAIXA

# 14.4V





**FAIXA**

**18V**

**Li-ion  
5Ah**

# MÁXIMO DESEMPENHO

A plataforma de 18 V inclui ferramentas capazes de oferecer o mais elevado desempenho para executar as aplicações mais exigentes.



Bateria 18V 5Ah para garantir um elevado desempenho com 4 LEDs para indicar autonomia residual.



Luz LED potente para uma iluminação eficiente da área de trabalho.

## PARAFUSO

PAR MÉDIO

POR ALTO



FG 305/LT2    FG 310/LT2    FG 315/LT2    FG 320/LT2

TECNOLOGIA DO MOTOR	Brushless	Brushless	Brushless	Brushless
ATAQUE	1/2"	1/2"	1/2"	3/4"
BATERÍA	18V - 5Ah	18V - 5Ah	18V - 5Ah	18V - 5Ah
TORQUE MÁXIMO PARAFUSADO (NM)	470	740	950	950
TORQUE MÁXIMO DESPARAFUSADO (NM)	510	880	1800	1800
Ø PARAFUSO	M10 - M16	M16-M22	M12-M32	M12-M32
VEL. VAZIO (RPM)	0-2500	0-2200	0-1800	0-1750
PESO COM BATERIA (GR)	1.890	2.360	3.450	3.560

## PARAFUSANDO/PERFURAÇÃO

FG 330/LT2

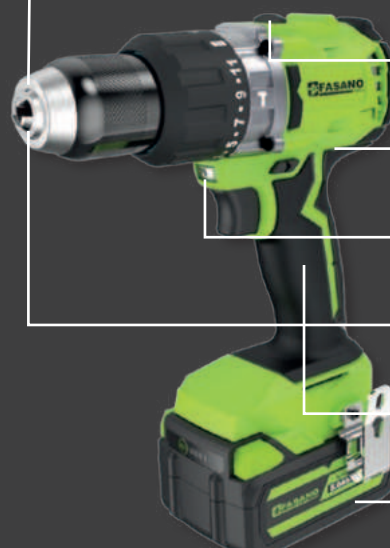

MANDRIL AUTOBLOQUEANTE EM AÇO 13mm

VELOCIDADE SEM CARGA 0-550/2000 rpm

MOTOR SEM ESCOVAS

LUZ LED PARA ILUMINAR A ÁREA DE TRABALHO

PERFURAÇÃO MÁXIMA 89/13/16mm madeira/metal/alvenaria

ALÇA ERGONÓMICA REVESTIDO A BORRACHA

BATERÍA 18V - 5Ah



Caixa em ABS com pega em borracha antiderrapante. Ideal para o transporte e armazenamento prático de ferramentas e do seu equipamento de série (bateria dupla de 18 V-5 Ah, carregador e gancho para cinto).





FAIXA  
**18V**

POWER  
TOOLS

FG 305/LT2

~~975,00€~~

499,00€

NEW

**CHAVE DE IMPACTO 1/2" - 18V**

Motor sem escovas

Binário máximo de 470 Nm ao aparafusar e 510 Nm ao desaparafusar

4 modos de funcionamento para parafusar

2 modos de funcionamento para desaparafusar

Função de controlo do aperto para controlo do aperto

Modo de remoção suave do parafuso, evita que o parafuso caia ao desaparafusar

Design compacto

LED triplo para iluminar a área de trabalho

Âmbito de fornecimento: 2 baterias de íões de lítio 18V - 5Ah,

carregador de bateria, gancho metálico para cinto, mala de

transporte em ABS com clipe metálico de fecho



DIMENSÕES



LED TRIPLÓ

1/2"

18V

BRUSHLESS  
MOTOR

LI-ION  
BATTERY

CE

FG 310/LT2

~~1075,00€~~

539,00€

NEW

**CHAVE DE IMPACTO 1/2" - 18V**

Motor sem escovas

Binário máximo de 740 Nm ao aparafusar e 880 Nm ao desaparafusar

4 modos de funcionamento para parafusar

2 modos de funcionamento para desaparafusar

Função de controlo do aperto para controlo do aperto

Modo de remoção suave do parafuso, evita que o parafuso caia ao desaparafusar

Design compacto

LED triplo para iluminar a área de trabalho

Âmbito de fornecimento: 2 baterias de íões de lítio 18V - 5Ah,

carregador de bateria, gancho metálico para cinto, mala de

transporte em ABS com clipe metálico de fecho



DIMENSÕES



LED TRIPLÓ

1/2"

18V

BRUSHLESS  
MOTOR

LI-ION  
BATTERY

CE

FG 315/LT2

1.175,00€

599,00€

NEW

**CHAVE DE IMPACTO 1/2" - 18V**

Motor sem escovas  
Binário máximo de 950 Nm ao aparafusar e 1800 Nm ao desaparafusar  
4 modos de funcionamento para parafusar  
2 modos de funcionamento para desaparafusar  
Função de controlo do aperto para controlo do aperto  
Modo de remoção suave do parafuso, evita que o parafuso caia ao desaparafusar  
Design compacto  
LED triplo para iluminar a área de trabalho  
Âmbito de fornecimento: 2 baterias de íões de lítio 18V - 5Ah, carregador de bateria, gancho metálico para cinto, mala de transporte em ABS com clipe metálico de fecho



DIMENSÕES



LED TRIPLÔ

1/2" 18V BRUSHLESS MOTOR LI-ION BATTERY CE

FG 320/LT2

1.255,00€

649,00€

NEW

**CHAVE DE IMPACTO 3/4" - 18V**

Motor sem escovas  
Binário máximo de 950 Nm ao aparafusar e 1800 Nm ao desaparafusar  
4 modos de funcionamento para parafusar  
2 modos de funcionamento para desaparafusar  
Função de controlo do aperto para controlo do aperto  
Modo de remoção suave do parafuso, evita que o parafuso caia ao desaparafusar  
Design compacto  
LED triplo para iluminar a área de trabalho  
Âmbito de fornecimento: 2 baterias de íões de lítio 18V - 5Ah, carregador de bateria, gancho metálico para cinto, mala de transporte em ABS com clipe metálico de fecho



DIMENSÕES



LED TRIPLÔ

3/4" 18V BRUSHLESS MOTOR LI-ION BATTERY CE

FG 330/LT2

985,00€

549,00€

NEW

**BERBEQUIM COM PERCUSSÃO - 18V**

Motor sem escovas  
Alto desempenho, até 135 Nm de binário máximo  
Mandril metálico sem chave de 13 mm  
11 posições de ajuste de binário  
Velocidade dupla  
Percussão máxima: 32000 Rpm  
Luz LED para iluminar a área de trabalho  
Embraiagem eletrónica  
Sistema Anti Kick Back para máximo controlo da ferramenta  
Âmbito de fornecimento: 2 baterias de íões de lítio 18V - 5Ah, carregador de bateria, gancho metálico para cinto, pega lateral, mala de transporte em ABS com clipe metálico de fecho



DIMENSÕES



ALTO DESEMPENHO EM TODAS AS APLICAÇÕES

18V BRUSHLESS MOTOR LI-ION BATTERY CE





FAIXA

**14.4V****FG 360/LT1**~~505,00€~~**299,00€**

NEW

**ROQUETE 1/2" - 14,4V**

Motor sem escovas

Elevado desempenho, binário máximo até 95 Nm

Velocidade em vazio 300 RPM

Cabeça fina

Velocidade variável

Luz LED para iluminar a área de trabalho

Âmbito de fornecimento: 1 bateria de lítio 14,4V - 2Ah, 1

carregador de bateria, mala de transporte em ABS com clip de

fecho metálico

**14.4V****BRUSHLESS  
MOTOR**LI-ION  
BATTERY

CE



DIMENSÕES

CABEÇA FINA PARA MÁXIMA  
ACESSIBILIDADE**FG 363/LT1**~~515,00€~~**309,00€**

NEW

**ROQUETE 3/8" - 14,4V**

Motor sem escovas

Elevado desempenho, binário máximo até 95 Nm

Velocidade em vazio 550 RPM

Cabeça fina

Velocidade variável

Luz LED para iluminar a área de trabalho

Âmbito de fornecimento: 1 bateria de lítio 14,4V - 2Ah, 1

carregador de bateria, mala de transporte em ABS com clip de

fecho metálico

**14.4V****BRUSHLESS  
MOTOR**LI-ION  
BATTERY

CE



DIMENSÕES

DESENHO LONGO PARA ACEDER AOS  
LOCAIS MAIS DIFÍCEIS**FG 366/LT1**~~535,00€~~**319,00€**

NEW

**ROQUETE LONGO DE 1/4" - 14,4V**

Motor sem escovas

Máxima eficiência, até 61 Nm de binário máximo a uma

velocidade de 500 rpm

Design longo

Velocidade variável

Luz LED para iluminar a área de trabalho

Âmbito de fornecimento: 1 bateria de lítio 14,4V - 2Ah, 1

carregador de bateria, mala de transporte em ABS com clip de

fecho metálico

**14.4V****BRUSHLESS  
MOTOR**LI-ION  
BATTERY

CE

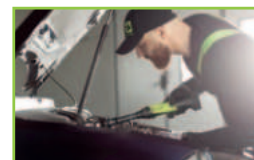

DIMENSÕES

DESENHO LONGO PARA ACEDER AOS  
LOCAIS MAIS DIFÍCEIS



FG 370/LT1

620,00€

369,00€

NEW

LIXADORA DE CINTA - 14,4V 10X330MM

Motor sem escovas  
Correia 10x330 mm  
Velocidade variável  
Velocidade em vazio 20000 RPM  
Velocidade da correia: 0-1327 m/min  
Design leve e ergonómico  
Luz LED para iluminar a área de trabalho  
Âmbito de fornecimento: 1 bateria de lítio 14,4V - 2Ah, 1 carregador de bateria, mala de transporte em ABS com clip de fecho metálico

14.4V

BRUSHLESS MOTOR

LI-ION BATTERY

CE



DIMENSÕES



BRAÇO GIRATÓRIO DE 360°

FG 373/LT1

610,00€

359,00€

NEW

LIXADORA DE CINTA - 14,4V 20X520MM

Motor sem escovas  
Correia 20x520 mm  
Velocidade variável  
Velocidade em vazio 20000 RPM  
Velocidade da correia: 0-1327 m/min  
Design leve e ergonómico  
Luz LED para iluminar a área de trabalho  
Âmbito de fornecimento: 1 bateria de lítio 14,4V - 2Ah, 1 carregador de bateria, mala de transporte em ABS com clip de fecho metálico

14.4V

BRUSHLESS MOTOR

LI-ION BATTERY

CE



DIMENSÕES



BRAÇO GIRATÓRIO DE 360°

FG 380/LT1

530,00€

319,00€

NEW

MINI MOINHO RETO 14,4V

Motor sem escovas  
4 velocidades  
Design compacto  
Velocidade em vazio 24500 RPM  
Cabeça reta com ligação de pinça de 6 mm  
Diâmetro máximo do disco 55 mm  
Luz LED para iluminar a área de trabalho  
Âmbito de fornecimento: 1 bateria de íões de lítio 14,4V - 2Ah, 1 carregador de bateria, mala de transporte em ABS com clipe de fecho metálico

14.4V

BRUSHLESS MOTOR

LI-ION BATTERY

CE



DIMENSÕES



PAINEL DE CONTROLO DA VELOCIDADE DE TRABALHO

FG 383/LT1

535,00€

299,00€

NEW

MINI REBARBADORA 14,4V

Motor sem escovas  
4 velocidades - Design compacto  
Velocidade em vazio 24500 RPM  
Cabeça reta com ligação de pinça de 6 mm  
Diâmetro máximo do disco 55 mm  
Luz LED para iluminar a área de trabalho  
Âmbito de fornecimento: 1 bateria de íões de lítio 14,4V - 2Ah, 1 carregador de bateria, mala de transporte em ABS com clipe de fecho metálico

14.4V

BRUSHLESS MOTOR

LI-ION BATTERY

CE



DIMENSÕES



PAINEL DE CONTROLO DA VELOCIDADE DE TRABALHO



## EXTRACTORES

FG 162/S3

366,00€

229,00€

## JOGO DE 3 EXTRACTORES UNIVERSAIS

27-90 mm, 27-135 mm, 35-155 mm



## EXTRATOR UNIVERSAL DE 2 GRELHAS

Modelo tipo tesoura

Mordentes ajustáveis em aço cromo-vanádio

Punho exterior

Parafuso em aço cromo-vanádio



CÓDIGO	A/MM	€/LISTA	€/PROMO
FG 162/FR1	90	155,00€	89,90€
FG 162/FR2	125	205,00€	119,00€
FG 162/FR3	125	237,00€	139,00€

## EXTRACTOR DE 2 PERNAS FINAS

Mordentes intercambiáveis super-finos de 2 mm em aço cromo-vanádio

Punho interno e externo

Parafuso em aço cromo-vanádio



CÓDIGO	A/MM	B/MM	C/MM	€/LISTA	€/PROMO
FG 168/EF1	110	140	186	325,00€	195,00€
FG 168/EF2	195	140	186	335,00€	205,00€

## EXTRACTOR DE 2/3 PERNAS

Equipado com 3 mordentes para agarrar no interior e 3 mordentes para agarrar no exterior

Mordentes em aço cromo-vanádio



CÓDIGO	Ø INTERNA	Ø ESTERNA	€/LISTA	€/PROMO
FG 165/IE1	25-100mm	0-75mm	320,00€	189,00€
FG 165/IE2	45-150mm	40-130mm	760,00€	459,00€

**EXTRACTOR DE PERCUSSÃO**  
M12x1.5



CÓDIGO	PER	€/LISTA	€/PROMO
FG 165/MB1	FG 165/IE1	170,00€	99,00€
FG 165/MB2	FG 165/IE2	330,00€	199,00€

**FG 168SD/S4**

~~155,00€~~ **95,00€**

**JOGO 4 QUEBRA PORCAS**

Conteúdo: FG 164/SD1 - SD4



**JOGO DE EXTRAÇÃO PARA PORCAS DIREITAS DANIFICADAS COM LIGAÇÃO DE 1/2"**

Fornecido num suporte em ABS suspensível com ganchos de fixação e mecanismo de interruptor de limite anti-queda

1/2"



CÓDIGO	CONTENUTO	€/LISTA	€/PROMO
FG 168A/S5	22, 24, 27, 30, 32 mm	115,00€	69,00€
FG 168A/S13	8, 9, 10, 11, 12, 13, 14, 15, 16, 17, 18, 19, 21 mm	220,00€	129,00€

**FG 168EP/S5**

~~35,00€~~ **19,90€**

**EXTRACTORES CÔNICOS DE PARAFUSOS EM AÇO LIGADO**

Inserção por percussão



**FG 168/S25**

~~144,00€~~ **79,00€**

**EXTRACTORES CÔNICOS DE PARAFUSOS EM AÇO LIGADO**

Equipado com guias internas e externas e brocas  
Utilização: parafusos com diâmetro 6-16mm

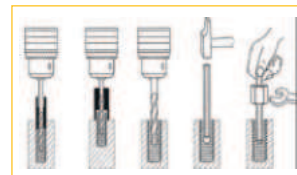

**FG 168/S9**

~~188,00€~~ **119,00€**

**JOGO 9 SACA PERNOS COM ROLETE**

Conteúdo: FG 168/R6 - R16



**FG 182/S5B**

~~475,00€~~ **285,00€**

**JOGO EXTRACTORES DE PERCUSSÃO E ACESSÓRIOS**



**FG 182/S14**

~~248,00€~~ **149,00€**

**JOGO DE EXTRACTORES DE ROLAMENTOS DE ESFERAS**

Ø/mm 5,6,8,9,11,12,5







# FERRAMENTAS DE AR

FGA 307

250,00€

149,00€

CHAVE DE IMPACTO-1/2"

- 1.200
- 746 Nm
- 610 Nm
- 136 L/min
- 9.500 RPM
- 6:2 Bar



CE



Martello singolo



FGA 307/AN

340,00€

189,00€

CHAVE DE IMPACTO ANGULAR -1/2"

- 1.150
- 420 Nm
- 244 Nm
- 113 L/min
- 9.000 RPM
- 6:2 Bar



CE



Martello singolo



FGA 309

300,00€

179,00€

CHAVE DE IMPACTO-1/2"

- 1.900
- 1.085 Nm
- 746 Nm
- 151 L/min
- 7.300 RPM
- 6:2 Bar



CE



Martello doppio



FGA 312

380,00€

199,00€

CHAVE DE IMPACTO-1/2"

- 2.000
- 1.130 Nm
- 950 Nm
- 136 L/min
- 7.500 RPM
- 6:2 Bar



CE



Martello doppio



FGA 309/S4

390,00€

239,00€

JOGO CHAVE DE IMPACTO FGA 309 + 03 CHAVES DE PORCAS PARA RODAS

CE



FGA 309/S10

410,00€

249,00€

JOGO CHAVE DE IMPACTO FGA 309 + 9 CHAVES DE CAIXA REFORÇADO

CE



FGA 302

240,00€

139,00€

CHAVE DE IMPACTO-1/2"

CE



Martello doppio

2.100

880 Nm

745 Nm

127 L/min

7.800 RPM

6:2 Bar

FGA 290

205,00€

119,00€

ROQUETE PNEUMÁTICO 1/4"

Sistema de reversibilidade integrado na cabeça

Sistema de acionamento da pinça

Ligação de ar 1/4" gás

Mangueira de ar interna Ø 10mm (3/8")

CE



FGA 291/D

188,00€

119,00€

MINI ROQUETE PNEUMÁTICO 1/4"

Ligação de ar 1/4" gás

Mangueira de ar interna Ø 10mm (3/8")

NEW

CE



FGA 292/B

218,00€

139,00€

ROQUETE PNEUMÁTICO 1/2"

CE



244 Nm  
MAX TORQUE

300 RPM

3/8" 10mm

1.300

105 L/min

6:2 Bar





# FERRAMENTAS PNEUMÁTICAS

**FGA 316/L**

~~830,00€~~

**499,00€**

CHAVE DE IMPACTO DE 3/4"  
- ÁRVORE LONGO 6"

**FGA 316**

~~760,00€~~

**449,00€**

CHAVE DE IMPACTO -3/4"



MARTELO DUPLA

CE



**FGA 319/L**

~~1.350,00€~~

**799,00€**

CHAVE DE IMPACTO DE 1"  
- ÁRVORE LONGO 6"

**FGA 319**

~~1.250,00€~~

**699,00€**

CHAVE DE IMPACTO -1"



Pin-less

CE



**FGA 321/B**

~~1.250,00€~~

**669,00€**

CHAVE DE IMPACTO DE 1"  
- ÁRVORE LONGO 6"

**FGA 321**

~~1.200,00€~~

**649,00€**

CHAVE DE IMPACTO -1"

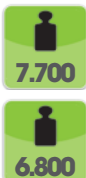

MARTELO DUPLA

2.983 Nm

MAX TORQUE

CE



**FGA 321/C**

~~1.350,00€~~

**749,00€**

CHAVE DE IMPACTO DE 1"  
- ÁRVORE LONGO 6"



Pin-less

CE



IDEAL PARA USO INTENSIVO



**FGA 390**

~~155,00€~~ **89,00€**

**MANÔMETRO**

Corpo em alumínio niquelado  
Revestimento de borracha resistente ao óleo  
Manômetro Ø80 (0-10bar)  
Proteção contra sobrepresão  
Alavanca de drenagem/insuflação de duas posições  
Comprimento do tubo: 500 mm



**FGA 322**

~~140,00€~~ **85,00€**

**VULCANIZER PNEUMÁTICO**



**FGA 332**

~~145,00€~~ **89,00€**

**BERBEQUIM REVERSÍVEL - BUCHA DE APERTO RÁPIDO: 1-10MM**



**FGA 333**

~~185,00€~~ **109,00€**

**BERBEQUIM REVERSÍVEL - BUCHA DE APERTO RÁPIDO: 1-13MM**



**FGA 333/AC**

~~210,00€~~ **129,00€**

**BERBEQUIM REVERSÍVEL - BUCHA DE APERTO EM AÇO: 1-13MM**



**FGA 332/AN**

~~180,00€~~ **109,00€**

**BERBEQUIM ANGULAR - BUCHA DE APERTO RÁPIDO: 1-10MM**





**FGA 340**

295,00€

169,00€

**LIXADEIRA DE DISCO ORBITAL**

- Ø orbital: 5mm - con 15 agujeros

152mm	11.000 RPM	900
45.2 L/min	1/2" 13mm	6:2 Bar

150mm	11.000 RPM	800
46 L/min	1/4" 6mm	6:2 Bar



**FGA 340/B**

295,00€

169,00€

**LIXADEIRA DE DISCO ORBITAL**

- Ø orbital: 2.5mm - con 15 agujeros

**FGA 341**

650,00€

399,00€

**LIXADEIRA MULTIUSOS**

Sistema de aspiração integrado no corpo da máquina

Suporte lateral giratório de 180

Ligação de ar 1/4" para gás

Mangueira de ar interna Ø 10mm (3/8")



**FGA 342/B**

285,00€

169,00€

**LIXADEIRA DE DISCO ORBITAL**

Órbita Ø: 2.5 mm

Almofada de apoio 3 furos



75mm	11.000 RPM	500
46 L/min	1/4" 6mm	6:2 Bar



**FGA 342**

220,00€

129,00€

**LIXADEIRA DE DISCO ORBITAL**

Diâmetro da órbita: 2 mm



13.000 RPM	45 L/min	3/8" 10mm	500
------------	----------	-----------	-----

**FGA 343/N10**

230,00€

139,00€

**LIXADEIRA DE CINTA**

Tamanho da fita: 10x330mm



(0.70) Hp	18.000 RPM	800	90 L/min	1/4" 6mm	6:2 Bar
-----------	------------	-----	----------	----------	---------

**FGA 343/N20**

295,00€

179,00€

**LIXADEIRA DE CINTA**

Tamanho da fita: 20x520mm



(0.70) Hp	18.000 RPM	960	107 L/min	1/4" 6mm	6:2 Bar
-----------	------------	-----	-----------	----------	---------

**FGA 337**

**125,00€**

**79,00€**

LIXADEIRA PARA REMOVER BORRACHA



**FGA 330**

**295,00€**

**179,00€**

SERRA PNEUMÁTICA

CE



**FGA 339**

**355,00€**

**199,00€**

REBARBADORA - Ø DISCO: 115MM

Capacidade do disco: 115 mm

Sistema de regulação da velocidade da pinça

Ligação de ar 1/4" gás

Mangueira de ar interna Ø 10mm (3/8")

CE



**FGA 346/B**

**220,00€**

**139,00€**

MICRO RECTICADORA

Capacidade da pinça: 3 mm

CE



**FGA 335**

**210,00€**

**119,00€**

REBITADORA PNEUMÁTICA

4 cabeças intermutáveis

CE



**FGA 336**

**600,00€**

**379,00€**

REBITADORA PNEUMÁTICA

4 cabeças intermutáveis

CE







FGA 338

125,00€

75,00€

RECTIFICADORA PNEUMÁTICA



LÂMINAS EM IN KEVLAR



FGA 334

145,00€

89,00€

RECTIFICADORA PNEUMÁTICA



LÂMINAS EM IN KEVLAR



FGA 338/B

160,00€

99,00€

RECTIFICADORA PNEUMÁTICA DE BAIXA VELOCIDADE



LÂMINAS EM IN KEVLAR



FGA 334/AN115

185,00€

109,00€

RECTIFICADORA PNEUMÁTICA-115°



LÂMINAS EM IN KEVLAR



FGA 338/AN

170,00€

99,00€

RECTIFICADORA PNEUMÁTICA ANGULAR



LÂMINAS EM IN KEVLAR



FGA 334/AN

185,00€

109,00€

RECTIFICADORA PNEUMÁTICA ANGULAR



LÂMINAS EM IN KEVLAR



FGA 338/L

165,00€

99,00€

RECTIFICADORA PNEUMÁTICA LONGA



LÂMINAS EM IN KEVLAR



FGA 334/L

185,00€

109,00€

RECTIFICADORA PNEUMÁTICA LONGA



LÂMINAS EM IN KEVLAR

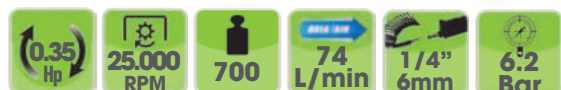



# ENROLADOR TUBO AUTOMÁTICO

CE



TUBO DE MALHA DE POLIURETANO  
SUPPORTE DE PAREDE AJUSTÁVEL DE 360°



FGA 383/AR15

275,00€

149,00€

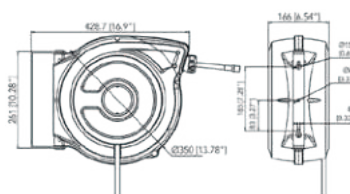

ENROLADOR TUBO AUTOMÁTICO  
PARA AR COMPRIMIDO -15MT  
- ø tubo interno: 8mm

FGA 385/AR15

360,00€

199,00€

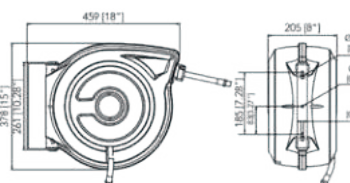

ENROLADOR TUBO AUTOMÁTICO  
PARA AR COMPRIMIDO -15MT  
- ø tubo interno: 10mm

GUIA DE DESLIZAMENTO  
AUTOMÁTICO

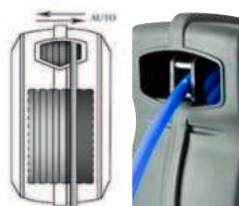

SISTEMA DE BLOQUEIO EM  
QUALQUER COMPRIMENTO

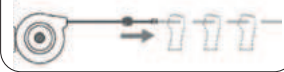

REBOBINAMENTO EM  
VELOCIDADE CONTROLADA



FGA 419

23,50€

14,90€

SOPRADOR

Válvula de abertura progressiva  
Corpo em alumínio niquelado  
Pega de borracha antiderrapante



CE

FGA 416

22,00€

13,90€

SOPRADOR

Válvula de abertura progressiva  
Rosca em latão



CE







# IL MEGLIO DEL MADE IN ITALY



Os nossos carrinhos são o resultado de intenso trabalho de investigação, desenvolvimento, design e produção interna.



## QUALIDADE, ROBUSTEZ E A ATENÇÃO AOS DETALHES SÃO AS CARACTERÍSTICAS DISTINTIVAS DOS NOSSOS CARRINHOS DE FERRAMENTAS

Uma gama completa de modelos que diferem no design, cores e características para oferecer ao utilizador as melhores soluções possíveis de acordo com as suas necessidades

FG 102



FG 100



FG 122



NEW

FG 150



## GAVETAS COMPATÍVEIS COM TODOS OS TERMOFORMADOS FERRAMENTAS FASANO



### STANDARD

DISPONÍVEL COM 5-6-7-8 GAVETAS  
EM 5 VARIANTES DE CORES + 14 VARIANTES DE CORES FG 100 BICOLOR

FG 104



FG 124



NEW

### XL

DISPONÍVEL COM 6-7 GAVETAS  
EM 4 VARIANTES DE CORES

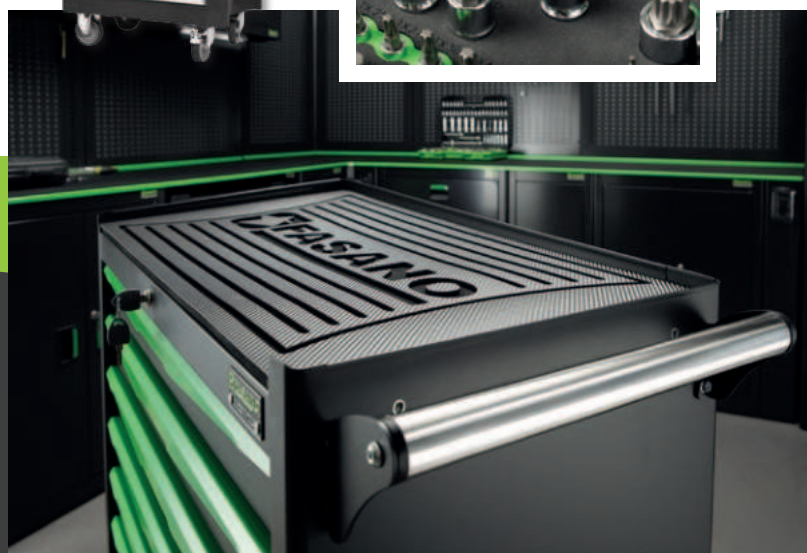

FG 105



FG 109



FG 160



FG 162



NEW

CAPACIDADE MÁXIMA  
2400Kg

## COM APÊNDICE LATERAL

DISPONÍVEL EM 4 VARIAÇÕES DE CORES

## COM SUPERFÍCIE DE TRABALHO ÚNICA

DISPONÍVEL EM 4 VARIAÇÕES DE CORES  
COM 14 GAVETAS



# FG 122



## CARRO COM 5 GAVETAS FG 122

Caixa electrosoldada  
 Guias telescópicas capacidade 45Kg  
 4 rodas de borracha vulcanizada Ø125mm (2 giratórias, 1 com travão)  
 Piso superior de borracha com acabamento em carbono 3D  
 Sistema de fecho centralizado  
 Gavetas equipadas com tapetes anti-riscos e previsão de divisórias interiores  
 Abertura total das gavetas  
 Puxador em aço inoxidável  
 Capacidade maxima gavetas: 45Kg



CÓDIGO				Gavetas	€/lista	€/PROMO
FG 122V/5G	FG 122D/5G	FG 122B/5G	FG 122R/5G	5	1.030,00€	499,00€
FG 122V/6G	FG 122D/6G	FG 122B/6G	FG 122R/6G	6	1.080,00€	529,00€
FG 122V/7G	FG 122D/7G	FG 122B/7G	FG 122R/7G	7	1.150,00€	599,00€

NEW

800 Kg **PORTATA**  
STATICA



TOP SUPERIOR EM BORRACHA COM ACABAMENTO EM CARBONO 3D

MADE IN ITALY



NOVO SISTEMA DE PRATELEIRAS PARA MAIS ABERTURA MAIS ESTÁVEL DA GAVETA



4 RODAS DE BORRACHA VULCANIZADA Ø125MM

# FG 124



## CARRO COM 6 GAVETAS MODELO FG 124

Caixa electrosoldada  
 Guias telescópicas capacidade 45Kg  
 4 rodas de borracha vulcanizada Ø125mm (2 giratórias, 1 com travão)  
 Piso superior de borracha com acabamento em carbono 3D  
 Sistema de fecho centralizado  
 Gavetas equipadas com tapetes anti-riscos e previsão de divisórias interiores  
 Abertura total das gavetas  
 Puxador em aço inoxidável  
 Capacidade maxima gavetas: 60kg



CÓDIGO				Gavetas	€/lista	€/PROMO
FG 124V/6G	FG 124D/6G	FG 124B/6G	FG 124R/6G	6	1.300,00€	639,00€
FG 124V/7G	FG 124D/7G	FG 124B/7G	FG 124R/7G	7	1.400,00€	689,00€

NEW

1000 Kg **PORTATA**  
STATICA

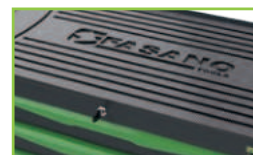

TOP SUPERIOR EM BORRACHA COM ACABAMENTO EM CARBONO 3D

MADE IN ITALY



NOVO SISTEMA DE PRATELEIRAS PARA MAIS ABERTURA MAIS ESTÁVEL DA GAVETA



4 RODAS DE BORRACHA VULCANIZADA Ø125MM

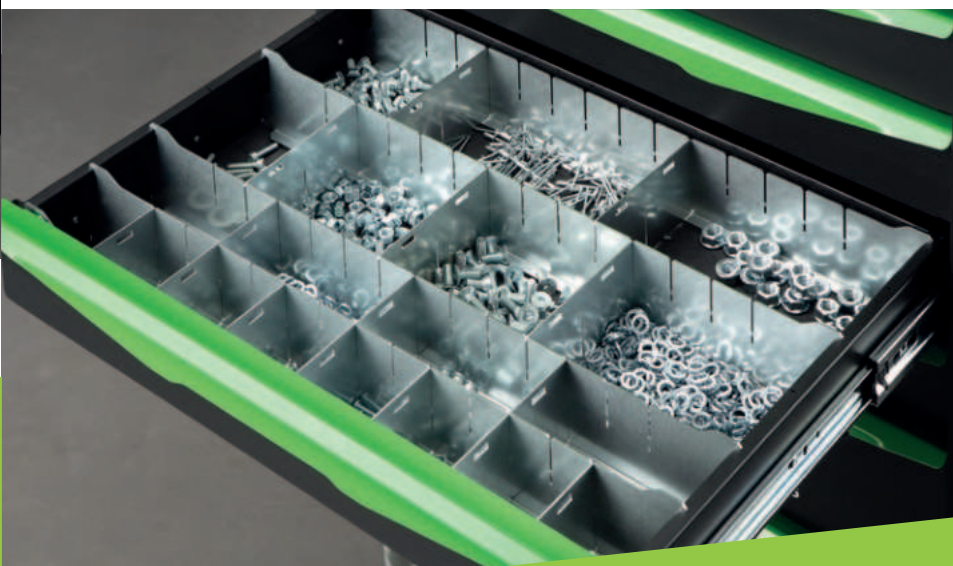

## DIVISORES PARA GAVETA

VER PÁGINA 397 DO CATÁLOGO SABER AS CONFIGURAÇÕES DISPONÍVEL





# FG 102

## CARRO DE FERRAMENTAS MODELO FG 102

Corrediças telescópicas com sistema de acoplamento automático  
 4 rodas de borracha vulcanizada Ø125mm (2 fixas, 1 giratória e 1 giratória com travão)  
 Pega lateral em aço inoxidável  
 Sistema de fecho centralizado  
 Gavetas equipadas com tapete de borracha interior  
 Tampo em espuma de borracha  
 Capacidade máxima gavetas: 45Kg

**800 Kg** PORTATA  
**STATICA**



4 RODAS Ø125

**MADE IN ITALY**



TOP DE BORRACHA



PUXADOR DE AÇO INOXIDÁVEL



CÓDIGO				Gavetas	€/lista	€/PROMO
FG 102V/5G	FG 102B/5G	FG 102R/5G	FG 102D/5G	5	880,00€	469,00€
FG 102V/6G	FG 102B/6G	FG 102R/6G	FG 102D/6G	6	940,00€	499,00€
FG 102V/7G	FG 102B/7G	FG 102R/7G	FG 102D/7G	7	1.010,00€	529,00€
FG 102V/8G	FG 102B/8G	FG 102R/8G	FG 102D/8G	8	1.100,00€	559,00€

# FG 104

## CARRO DE FERRAMENTAS MODELO FG 104

Corrediças telescópicas com sistema de acoplamento automático  
 4 rodas de borracha vulcanizada Ø125mm (2 fixas, 1 giratória e 1 giratória com travão)  
 Pega lateral em aço inoxidável  
 Sistema de fecho centralizado  
 Gavetas equipadas com tapete de borracha interior  
 Tampo em espuma de borracha  
 Capacidade máxima gavetas: 60Kg

**1000 Kg** PORTATA  
**STATICA**



TOP DE BORRACHA

**MADE IN ITALY**



PUXADOR DE AÇO INOXIDÁVEL



CÓDIGO				Gavetas	€/lista	€/PROMO
FG 104V/6G	FG 104B/6G	FG 104R/6G	FG 104D/6G	6	1.150,00€	579,00€
FG 104V/7G	FG 104B/7G	FG 104R/7G	FG 104D/7G	7	1.250,00€	599,00€



FECHO CENTRALIZADO





# FG 100



## CARRO DE FERRAMENTAS BICOLOR COM 7 GAVETAS MOD. FG 100

Corrediças telescópicas com sistema de acoplamento automático  
 4 rodas de borracha vulcanizada Ø125mm (2 fixas, 1 giratória, 1 giratória com travão)  
 Prateleira superior em ABS com pega integrada  
 Fecho lateral centralizado  
 Porta-garrafas lateral de série  
 Painéis laterais com orifícios para pendurar ganchos para ferramentas  
 5 gavetas 580x398x75 mm e 2 gavetas 580x398x135 mm  
 Abertura total das gavetas  
 Capacidade máxima gavetas: 45Kg

**800 Kg**  
PORTATA  
STATICA

**MADE IN ITALY**



CÓDIGO	RAL	€/lista	€/PROMO
FG 100VD/7T	6018+7021	1.350,00€	699,00€
FG 100VW/7T	6018+9016	1.350,00€	699,00€
FG 100BW/7T	5002+9016	1.350,00€	699,00€
FG 100BD/7T	5002+7021	1.350,00€	699,00€
FG 100RD/7T	3001+7021	1.350,00€	699,00€
FG 100RY/7T	3001+1018	1.350,00€	699,00€
FG 100CW/7T	5012+9016	1.350,00€	699,00€
FG 100MA/7T	3004+9016	1.350,00€	699,00€
FG 100RW/7T	3001+9016	1.350,00€	699,00€
FG 100RB/7T	3001+5002	1.350,00€	699,00€
FG 100DP/7T	7021+3015	1.350,00€	699,00€
FG 100DW/7T	7021+9016	1.350,00€	699,00€
FG 100BY/7T	5002+1018	1.350,00€	699,00€
FG 100GW/7T	3004+9016	1.350,00€	699,00€

# FG 100



## CARRO DE FERRAMENTAS MODELO FG 100

Corrediças telescópicas com sistema de acoplamento automático  
 4 rodas de borracha vulcanizada Ø125mm (2 fixas e 2 giratórias)  
 Fechos laterais centralizados  
 Prateleira superior em ABS e porta-ferramentas laterais  
 Porta-garrafas lateral de série  
 Painéis laterais com orifícios para pendurar ganchos para ferramentas  
 Capacidade máxima gavetas: 45Kg

**800 Kg**  
PORTATA  
STATICA

**MADE IN ITALY**



SISTEMA DE BLOQUEIO LATERAL



NOVA PEGA LATERAL DE AÇO

CÓDIGO	Gavetas	€/lista	€/PROMO
FG 100V/5T	5	1.000,00€	519,00€
FG 100V/6T	6	1.050,00€	539,00€
FG 100V/7T	7	1.100,00€	559,00€



GAVETA COM ABERTURA TOTAL







# FG 105



## CARRO PORTA FERRAMENTAS COM ARMÁRIO LATERAL

Corrediças telescópicas com sistema de acoplamento automático  
 4 rodas de borracha vulcanizada Ø125mm (2 fixas, 1 giratória e 1 giratória com travão)  
 Pega lateral em aço  
 Sistema de fecho centralizado  
 Gavetas equipadas com tapete de borracha interior  
 Tampo em espuma de borracha  
 Prateleiras interiores amovíveis e reguláveis  
 Porta com abertura de 90° e fechadura com chave  
 Capacidade máxima gavetas: 45Kg



PRATELEIRAS INTERNAS AJUSTÁVEIS

MADE IN ITALY



PORTA DE ABERTURA DE 90° BLOQUEÁVEL



CÓDIGO				Gavetas	€/lista	€/PROMO
FG 105V/5G	FG 105B/5G	FG 105R/5G	FG 105D/5G	5	1.300,00€	689,00€
FG 105V/6G	FG 105B/6G	FG 105R/6G	FG 105D/6G	6	1.400,00€	739,00€
FG 105V/7G	FG 105B/7G	FG 105R/7G	FG 105D/7G	7	1.450,00€	769,00€

# FG 109



## CARRO DE FERRAMENTAS COM APÊNDICE LATERAL

Corrediças telescópicas com sistema de acoplamento automático  
 4 rodas de borracha vulcanizada Ø125mm (2 fixas, 1 giratória e 1 giratória com travão)  
 Pega lateral em aço  
 Sistema de fecho centralizado  
 Gavetas equipadas com tapete de borracha interior  
 Tampo em espuma de borracha  
 Prateleiras interiores amovíveis e reguláveis  
 Porta com abertura de 90° e fechadura com chave  
 Capacidade máxima gavetas: 60Kg



TOP EM BORRACHA EXPANDIDA

MADE IN ITALY



PRATELEIRAS INTERIORES AMOVÍVEIS E REGULÁVEIS



CÓDIGO				Gavetas	€/lista	€/PROMO
FG 109V/6G	FG 109B/6G	FG 109R/6G	FG 109D/6G	6	1.600,00€	849,00€
FG 109V/7G	FG 109B/7G	FG 109R/7G	FG 109D/7G	7	1.650,00€	879,00€





A PORTA ABRE A 110°

MADE IN ITALY

# NEW FG 162



PUXADOR DE AÇO INOXIDÁVEL



GAVETAS EQUIPADAS COM TAPETE INTERIOR

### CARACTERÍSTICAS TÉCNICAS:

Guias telescópicas de fecho automático  
Pega lateral de aço inoxidável  
Suporte para rolo e porta-latas incluídos  
Gavetas equipadas com tapete de borracha interior  
Painéis laterais com orifícios para ganchos de ferramentas  
Prateleira superior em chapa de 2mm, **com top em policarbonato**  
4 rodas de borracha vulcanizada Ø160mm (2 fixas, 2 giratórias com travão)  
Portas que abrem a 110°, equipadas com fechadura e 2 prateleiras interiores amovíveis  
Grelha porta-ferramentas lateral (530x240mm)  
14 gavetas: 5 gavetas 580x398x75mm, 2 gavetas 580x398x135mm, 5 gavetas 580x235x75mm, 2 gavetas 580x235x135mm  
Capacidade da gaveta: 45Kg



FG 162V/14P FG 162B/14P FG 162R/14P FG 162D/14P

### CARRO PORTA FERRAMENTAS 14 GAVETAS MOD. FG 162

CÓDIGO	RAL	Capacidade kg	N. gavetas	€/Lista	€/PROMO
FG 162V/14P	6018	2400	14	3.300,00	1.799,00
FG 162B/14P	5002	2400	14	3.300,00	1.799,00
FG 162R/14P	3001	2400	14	3.300,00	1.799,00
FG 162D/14P	7021	2400	14	3.300,00	1.799,00

2400 Kg PORTATA STATICA

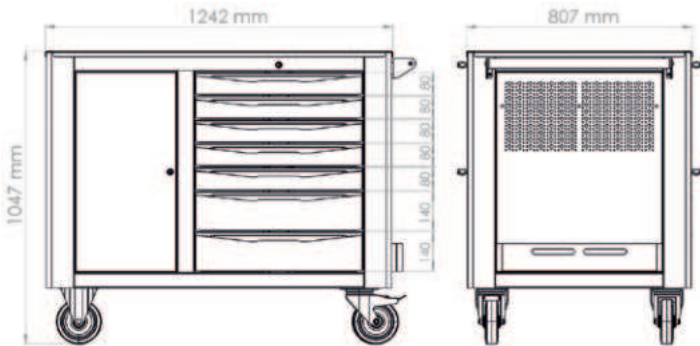

A PORTA ABRE A 110°



POSSIBILIDADE APLICAR VÁRIOS ACESSÓRIOS



7 GAVETAS TRAZ PEQUENAS PEÇAS



# FG 160

### CARACTERÍSTICAS TÉCNICAS:

Guias telescópicas de fecho automático  
Pega lateral de aço inoxidável  
Suporte para rolo e porta-latas incluídos  
Gavetas equipadas com tapete de borracha interior  
Painéis laterais com orifícios para ganchos de ferramentas  
Prateleira superior em chapa de 2mm, **com top em contraplacado de bétula fenólico**  
4 rodas de borracha vulcanizada Ø160mm (2 fixas, 2 giratórias com travão)  
Portas que abrem a 110°, equipadas com fechadura e 2 prateleiras interiores amovíveis  
Grelha porta-ferramentas lateral (530x240mm)  
14 gavetas: 5 gavetas 580x398x75mm, 2 gavetas 580x398x135mm, 5 gavetas 580x235x75mm, 2 gavetas 580x235x135mm  
Capacidade da gaveta: 45Kg

MADE IN ITALY

### CARRO PORTA FERRAMENTAS 14 GAVETAS MOD. FG 160

CÓDIGO	RAL	Capacidade kg	N. gavetas	€/Lista	€/PROMO
FG 160V/14L	6018	2400	14	3.200,00	1.699,00
FG 160B/14L	5002	2400	14	3.200,00	1.699,00
FG 160R/14L	3001	2400	14	3.200,00	1.699,00
FG 160D/14L	7021	2400	14	3.200,00	1.699,00



FG 160V/14L FG 160B/14L FG 160R/14L FG 160D/14L

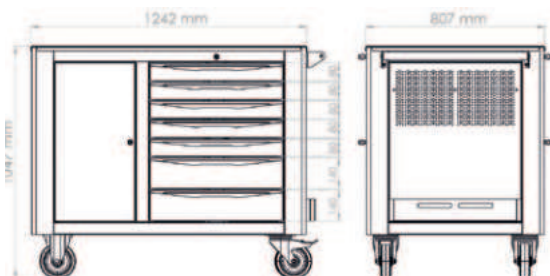





# FG 150



## CARRO DE FERRAMENTAS MODELO FG 150

Corrediças telescópicas com sistema de acoplamento automático  
 4 rodas de borracha vulcanizada Ø125mm (2 fixas, 2 giratórias)  
 Pega lateral em aço  
 Sistema de fecho centralizado  
 Gavetas equipadas com tapete de borracha interior  
 Top em espuma de borracha  
 3 gavetas 580x398x54mm, 1 gaveta 580x398x110mm e 1 gaveta 580x398x200mm  
 Capacidade das gavetas: 30Kg

800 Kg **PORTATA STÁTICA**



TOP DE BORRACHA

**MADE IN ITALY**



PEGA DE AÇO

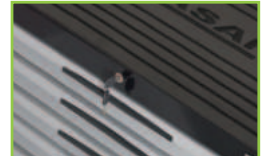

FECHO CENTRALIZADO



CÓDIGO	Gavetas	€/lista	€/PROMO	
FG 150D/5G	FG 150R/5G	5	1.100,00€	589,00€
FG 150D/6G	FG 150R/6G	6	1.150,00€	629,00€
FG 150D/7G	FG 150R/7G	7	1.200,00€	659,00€

# FG 101



## CARRO DE FERRAMENTAS MODELO FG 101

Corrediças telescópicas com sistema de acoplamento automático  
 4 rodas de borracha vulcanizada Ø125mm (2 fixas, 1 giratória e 1 giratória com travão)  
 Pega lateral em aço pintado  
 Sistema de fecho centralizado  
 Sistema de abertura por baioneta  
 Gavetas com tapete de borracha interior  
 Tampo em borracha macia  
 Cor fixa em dark  
 Capacidade das gavetas: 35kg

500 Kg **PORTATA STÁTICA**



SISTEMA DE ABERTURA DE BAIONETA



PEGA EM AÇO

CÓDIGO	Gavetas	€/lista	€/PROMO
FG 101D/5G	5	680,00€	359,00€
FG 101D/6G	6	710,00€	379,00€
FG 101D/7G	7	750,00€	399,00€



TOP DE BORRACHA





**FG 101V/3G**

~~500,00€~~

**249,00€**

**CARRO COM 3 GAVETAS MODELO FG 101**



Possibilidade de inserção de módulos de ferramentas



2 prateleiras (porta objectos superior e inferior 680x440 mm)

**FG 94/MI**

~~52,00€~~

**24,90€**

**PORTA FERRAMENTAS MAGNÉTICO**

Dimensões 120x94x400 mm



Fixação magnética

**FG 94/MS**

~~34,00€~~

**18,90€**

**PORTA FERRAMENTAS MAGNÉTICO**

PVC resistente a riscos



Fixação magnética

**FG 108/B**

~~150,00€~~

**89,00€**

**CARRINHO MULTI SERVIÇO UNIVERSAL PARA PEÇAS PEQUENAS E FERRAMENTAS DE TRABALHO**



Equipado com 16 tabuleiros amovíveis para peças pequenas



Estrutura lateral em alumínio e prateleiras e acessórios em ABS

**FG 94/R**

~~20,00€~~

**11,90€**

**PORTA FERRAMENTAS MAGNÉTICO**

Dimensões 165x245 mm



Fixação magnética

**FG 94/T**

~~17,00€~~

**9,90€**

**PORTA FERRAMENTAS MAGNÉTICO**

Ø 150 mm



Fixação magnética



FG 101D/AS165

1.684,00€

699,00€

CARRO DE FERRAMENTAS COM 6 GAVETAS, MODELO FG 101, COM UM SORTIDO DE 165 FERRAMENTAS EM MÓDULOS RÍGIDOS



**SORTIDO 165 FERRAMENTAS**

1º GAVETA



- FG 102/03G: Módulo rígido 14 llaves boca/ lunetas poligonales
- FG 102/17E: Módulo 65 herramientas de 1/4"
- FG 102/21E: Módulo chaves de caixas 6PT

2º GAVETA



- FG 102/48G: Módulo rígido 52 puntas de 10mm
- FG 102/VA1: Módulo rígido porta-objectos
- FG 102/65B: Módulo rígido 2 alicates ajustavel

3º GAVETA



- FG 102/45D: Módulo rígido 6 chaves de fenda sl e ph
- FG 102/45I: Módulo rígido 6 chaves de fenda torx
- FG 102/39D: Módulo rígido 3 alicates



**SISTEMA DE ABERTURA DE BAIONETA**



FG 101D/AS196

~~2.133,00€~~

**799,00€**

**CARRO DE FERRAMENTAS COM 7 GAVETAS, MODELO FG 101,  
COM UM SORTIDO DE 196 FERRAMENTAS EM MÓDULOS RÍGIDOS**



**SORTIDO 196 FERRAMENTAS**

1° GAVETA



- FG 102/03G: Módulo rígido 14 llaves boca/ lunetas poligonales
- FG 102/17E: Módulo 65 herramientas de 1/4"
- FG 102/21B: Módulo de chave hexagonal 1/2" 8-32mm + acessórios

2° GAVETA



- FG 102/39D: Módulo rígido 3 alicates
- FG 102/45I: Módulo rígido 6 chaves Torx
- FG 102/45D: Módulo rígido 6 chaves de fenda sl e ph

3° GAVETA



- FG 102/48G: Módulo rígido 52 pontas de 10mm
- FG 102/60D: Módulo de ferramenta de manutenção
- FG 102/23C: Módulo rígido chaves de caixas reforçadas

4° GAVETA



- FG 618/A8, A10, A13, A17, A19: Chaves T hexagonais com juntas







FG 102V/AS205

2.558,00€

999,00€

CARRO DE FERRAMENTAS COM 6 GAVETAS, MODELO FG 102, COM UM SORTIDO DE 205 FERRAMENTAS EM MÓDULOS RÍGIDOS



CÓDIGO

FG 102V/AS205	FG 102B/AS205	FG 102R/AS205	FG 102D/AS205
---------------	---------------	---------------	---------------

SORTIDO 205 FERRAMENTAS



1º GAVETA



- FG 102/03G: Módulo rígido 14 llaves boca/ lunetas poligonales
- FG 102/17: Módulo 18 ferramentas de 1/4"
- FG 102/21B: Módulo de chave de caixa 1/2" 8-32mm + acessórios

2º GAVETA



- FG 102/21TX: Módulo rígido 44 ferramentas torx
- FG 102/21H: Módulo rígido chaves de ponta 1/2" hexagonais e xzn
- FG 102/39D: Módulo rígido 3 alicates

3º GAVETA



- FG 102/45F: Módulo rígido 6 chaves de fenda ph
- FG 102/45G: Módulo rígido 7 llaves de fenda sl
- FG 102/48G: Módulo rígido 52 pontas de 10mm

4º GAVETA



- FG 102/10C: Módulo de 8 chaves T de junta hexagonal 7-19mm

TOP DE BORRACHA



**FG 122V/AS168**

~~2.655,00€~~ **1.199,00€**

**CARRO DE FERRAMENTAS COM 7 GAVETAS, MODELO FG 122, COM UM SORTIDO DE 168 FERRAMENTAS EM MÓDULOS RÍGIDOS**



**CÓDIGO**

FG 122V/AS168	FG 122D/AS168	FG 122B/AS168	FG 122R/AS168
---------------	---------------	---------------	---------------

**SORTIDO 168 FERRAMENTAS**



**1º GAVETA**



- FG 102/03G: Módulo rígido 14 llaves boca/ lunetas poligonales
- FG 102/21B: Módulo de chave de caixa 1/2" 8-32mm + acessórios
- FG 102/17E: Módulo 65 ferramentas de 1/4"

**2º GAVETA**



- FG 102/42C: Módulo rígido 4 alicates de freios
- FG 102/21H: Módulo rígido chaves de ponta 1/2" hexagonais e xzn
- FG 102/39XT: Módulo 3 alicates

**3º GAVETA**



- FG 102/45F: Módulo rígido 6 chaves de fenda ph
- FG 102/45G: Módulo rígido 7 llaves de fenda sl
- FG 102/45I: Módulo rígido 6 chaves Torx

**4º GAVETA**



- FG 102/56C: Módulo rígido ferramentas de percussão
- FG 102/60D: Módulo de ferramenta de manutenção
- FG 102/65B: Módulo rígido 2 alicates ajustavel

**4 RODAS DE BORRACHA VULCANIZADO Ø125mm (2 FIXOS E 2 GIRATÓRIOS 1 COM TRAVÃO)**







FG 100V/AS212

2.751,00€

1.199,00€

CARRO DE FERRAMENTAS COM 7 GAVETAS, MODELO FG 100, COM UM SORTIDO DE 212 FERRAMENTAS EM MÓDULOS RÍGIDOS



CÓDIGO

FG 100V/AS212	FG 100B/AS212	FG 100R/AS212	FG 100D/AS212	FG 100W/AS212
---------------	---------------	---------------	---------------	---------------

SORTIDO 212 FERRAMENTAS

1º GAVETA



- FG 102/03G: Módulo rígido 14 llaves boca/ lunetas poligonales
- FG 102/03L: Módulo 6 chaves de bocas
- FG 102/21B: Módulo de chave de caixa 1/2" 8-32mm + acessórios

2º GAVETA



- FG 102/17E: Módulo 65 ferramentas de 1/4"
- FG 102/19: Módulo 18 ferramentas 3/8"
- FG 102/45I: Módulo rígido 6 chaves Torx

3º GAVETA



- FG 102/39XT: Módulo 3 alicates
- FG 102/42C: Módulo rígido 4 alicates de freios
- FG 102/45E: Módulo rígido 8 chaves de fenda sl e ph

4º GAVETA



- FG 102/56C: Módulo rígido ferramentas de percussão
- FG 102/65B: Módulo rígido 2 alicates ajustavel
- FG 102/48G: Módulo rígido 52 pontas de 10mm



NOVO PUNHO DE AÇO INTEGRADO





**FG 100V/AS183**

~~2.685,00€~~ **1.199,00€**

**CARRO DE FERRAMENTAS COM 7 GAVETAS, MODELO FG 100, COM UM SORTIDO DE 183 FERRAMENTAS EM MÓDULOS RÍGIDOS**



**CÓDIGO**

FG 100V/AS183	FG 100B/AS183	FG 100R/AS183	FG 100D/AS183	FG 100W/AS183
---------------	---------------	---------------	---------------	---------------

**SORTIDO 183 FERRAMENTAS**

**1º GAVETA**



- FG 102/03G: Módulo rígido 14 llaves boca/ lunetas poligonales
- FG 102/03L: Módulo 6 chaves de bocas
- FG 102/21B: Módulo de chave de caixa 1/2" 8-32mm + acessórios

**2º GAVETA**



- FG 102/17: Módulo 18 ferramentas de 1/4"
- FG 102/48G: Módulo rígido 52 pontas de 10mm
- FG 102/21TX: Módulo rígido 44 ferramentas Torx

**3º GAVETA**



- FG 102/39XT: Módulo 3 alicates
- FG 102/45D: Módulo rígido 6 chaves de fenda sl e ph
- FG 102/45I: Módulo rígido 6 chaves Torx

**4º GAVETA**



- FG 102/10C: Módulo de 8 chaves T de junta hexagonal 7-19mm

**GAVETA  
COM ABERTURA  
TOTAL**





FG 100V/AS371

3.785,80€ 1.399,00€

CARRO DE FERRAMENTAS COM 7 GAVETAS, MODELO FG 100, COM UM SORTIDO DE 371 FERRAMENTAS EM MÓDULOS RÍGIDOS



CÓDIGO

FG 100V/AS371	FG 100B/AS371	FG 100R/AS371	FG 100D/AS371	FG 100W/AS371
---------------	---------------	---------------	---------------	---------------

SORTIDO 371 FERRAMENTAS

1° GAVETA



- FG 102/03G: Módulo rígido 14 llaves boca/ lunetas poligonales
- FG 102/03L: Módulo 6 chaves de bocas
- FG 102/03E: Módulo rígido 8 chaves de boca

2° GAVETA



- FG 102/17E: Módulo 65 herramientas de 1/4"
- FG 102/19: Módulo 18 ferramentas 3/8"
- FG 102/21B: Módulo de chave de caixa 1/2" 8-32mm + acessórios

3° GAVETA



- FG 102/21TX: Módulo rígido 44 ferramentas Torx
- FG 102/21H: Módulo rígido chaves de ponta 1/2" hexagonais e xzn
- FG 102/21R: Módulo chaves de pontas ribe

4° GAVETA



- FG 102/56C: Módulo rígido ferramentas de percussão
- FG 102/39XT: Módulo 3 alicates
- FG 102/42C: Módulo rígido 4 alicates de freios

5° GAVETA



- FG 102/45G: Módulo rígido 7 chaves de fenda ph
- FG 102/45F: Módulo rígido 6 chaves de fenda ph
- FG 102/45I: Módulo rígido 6 chaves Torx

6° GAVETA



- FG 102/48G: Módulo rígido 52 pontas de 10mm
- FG 102/65B: Módulo rígido 2 alicates ajustavel
- FG 102/23C: Módulo rígido chaves de caixas reforçadas
- FG 85/S31: Jogo de bits de 1/4" + adaptador de suporte de bits de 1/4" x 1/4"





**FG 124V/AS231**

~~3.539,00€~~

**1.499,00€**

**CARRO DE FERRAMENTAS COM 7 GAVETAS, MODELO FG 124, COM UM SORTIDO DE 231 FERRAMENTAS EM MÓDULOS RÍGIDOS**



**CÓDIGO**

FG 124V/AS231

FG 124D/AS231

FG 124B/AS231

FG 124R/AS231

**SORTIDO 231 FERRAMENTAS**

**1º GAVETA**



- FG 102/03H: Módulo 18 chaves boca/lunetas poligonais
- FG 102/03E: Módulo rígido 8 chaves de boca
- FG 102/07C: Módulo 7 chaves de luneta com curvatura

**2º GAVETA**



- FG 102/17E: Módulo 65 ferramentas de 1/4"
- FG 102/21TX: Módulo rígido 44 ferramentas Torx
- FG 102/21B: Módulo de chave de caixa 1/2" 8-32mm + acessórios
- FG 102/21H: Módulo rígido chaves de ponta 1/2" hexagonais e xzn

**3º GAVETA**



- FG 102/42C: Módulo rígido 4 alicates de freios
- FG 102/39XT: Módulo 3 alicates
- FG 102/45D: Módulo rígido 6 chaves de fenda sl e ph
- FG 102/45I: Módulo rígido 6 chaves Torx

**4º GAVETA**



- FG 102/65B: Módulo rígido 2 alicates ajustavel
- FG 102/10C: Módulo de 8 chaves T de junta hexagonal 7-19mm

**NOVO DESIGN DA ALÇA**





**FG 102/03G**

~~140,00€~~

**85,00€**

**MÓDULO 14 CHAVES BOCA/LUNETAS MM**  
FG 600/B6,7,8,9,10,11,12,13, 14,15,16,17,18,19mm



1/3

**FG 102/07C**

~~98,00€~~

**59,90€**

**MÓDULO 7 CHAVES DE LUNETA CURVADAS**  
FG 615/B6x7, 8x9, 10x11,12x13, 14x15, 16x17, 18x19mm



1/3

**FG 102/03L**

~~145,00€~~

**89,00€**

**MÓDULO 6 CHAVES BOCA/LUNETAS MM**  
FG 600/B21, 22, 24, 27, 30, 32 mm



1/3

**FG 102/07D**

~~138,00€~~

**82,90€**

**MÓDULO 5 CHAVES DE LUNETA CURVADAS**  
FG 615/B20x22, 21x23, 24x27, 25x28, 30x32mm



1/3

**FG 102/03H**

~~250,00€~~

**149,00€**

**MÓDULO 18 CHAVES BOCA/LUNETAS MM**  
FG 600/B6,7,8,10,11,12,13,14,16,17,18,19, 21, 22, 24, 27, 30, 32mm



2/3

**FG 102/08C**

~~245,00€~~

**149,00€**

**MÓDULO 11 CHAVES COM ROQUETE**  
FG 605/B8, 10, 11, 12, 13, 14, 15, 16, 17, 18, 19mm



1/3

**FG 102/03E**

~~85,00€~~

**51,90€**

**MÓDULO 8 CHAVES DE BOCAS**  
FG 602/B6x7, 8x9, 10x11, 12x13, 14x15, 16x17, 18x19, 20x22 mm + FG 139C/FS



1/3

**FG 102/10C**

~~340,00€~~

**209,00€**

**MÓDULO 8 CHAVES EM T HEXAGONAIS**  
FG 618/A7, 8, 10, 11, 13, 14, 17, 19 mm



1/1

**FG 102/03F**

~~100,00€~~

**63,90€**

**MÓDULO 5 CHAVES DE BOCAS**  
FG 602/B21x23, 24x26, 25x28, 27x29, 30x32 mm



1/3

**FG 102/13C**

~~190,00€~~

**119,00€**

**MÓDULO 8 CHAVES DE CACHIMBO**  
FG 613/A6,7,8,10,11,12,13,14,17,19mm



1/3



FG 102/17

135,00€

79,90€

MÓDULO CHAVES DE CAIXAS 6PT

FG 615/B6x7, 8x9, 10x11,12x13, 14x15, 16x17, 18x19mm



1/3



MÓDULO CHAVES DE CAIXAS 6PT

10-23mm



1/3



CÓDIGO	ATAQUE	€/LISTA	€/PROMO
FG 102/21E	Sextavado	170,00€	99,00€
FG 102/21D	Poligonal	170,00€	99,00€

FG 102/17E

275,00€

159,00€

MÓDULO CHAVES DE CAIXAS 6PT

FG 605/B8, 10, 11, 12, 13, 14, 15, 16, 17, 18, 19mm



1/3



FG 102/21TX

245,00€

139,00€

MÓDULO FERRAMENTAS TORX



1/3



FG 102/19

200,00€

119,00€

MÓDULO CHAVES DE CAIXAS 6PT

8-23 Hexagonal

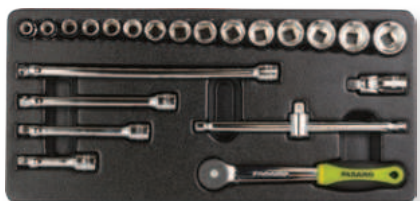

1/3



FG 102/21H

210,00€

129,00€

MÓDULO CHAVES DE PONTAS

FG 150/H2-H8, FG 150L/H2-H8, FG 150/M5-M16, FG 1

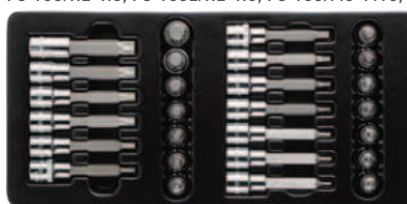

1/3



FG 102/19B

200,00€

119,00€

MÓDULO CHAVES DE CAIXAS 6PT

8- 23mm Poligonal



1/3



FG 102/21R

230,00€

139,00€

MÓDULO CHAVES DE PONTAS RIBE

FG 150/R4-R14, FG 150L/R4-R14, FG 150/R4-R14, FG 150L/R4-R14



1/3



MÓDULO CHAVES DE CAIXAS 6PT

10-23mm



1/3



MÓDULO CHAVES DE CAIXAS 6PT

34-50mm



1/2



CÓDIGO	ATAQUE	€/LISTA	€/PROMO
FG 102/21B	Sextavado	245,00€	139,00€
FG 102/21C	Poligonal	255,00€	139,00€

CÓDIGO	ATAQUE	€/LISTA	€/PROMO
FG 102/25	Sextavado	395,00€	239,00€
FG 102/25B	Poligonal	395,00€	239,00€



FG 102/23C

~~145,50€~~

89,00€

**MÓDULO CHAVES DE CAIXAS DE IMPACTO**

FG 628/C10,11,12,13,14,16,17,18,19,21,22,23,24mm + FG 628/PR125



1/3

1/2"

FG 102/51H

~~130,00€~~

79,90€

**MÓDULO DE 7 TECLAS HEXAGONAL**

FG 621/H2, 2.5, 3, 4, 5, 6, 8mm



1/3



FG 102/39XT

~~102,00€~~

59,90€

**MÓDULO 3 ALICATES**

FG 59/XT180 - FG 61/XT160 - FG 63XT160



1/3

FG 102/39D

~~75,00€~~

45,90€

**MÓDULO 3 ALICATES**

FG 59PV/180, FG 61PV/160, FG 63PV/160



1/3

**MÓDULO 4 ALICATES DE FREIOS**



1/3

FG 102/45D

~~47,00€~~

27,90€

**MÓDULO DE 6 CHAVES DE FENDA**

FG 22/3x100, 4x125, 5.5x150, 6.5x150,  
FG 22/PH1x80, PH2x150



1/3



FG 102/45E

~~57,00€~~

33,90€

**MÓDULO DE 8 CHAVES DE FENDA**

3x100, 4x125, 5.5x150, 6.5x150, 6.5x38,  
PH1x80, PH2x150, PH2x38



1/3



FG 102/45F

~~54,00€~~

32,90€

**MÓDULO DE 6 CHAVES DE FENDA**

PH0x60, PH1x150, PH2x100, PH2x150, PH3x150, PH2x38



1/3



FG 102/45G

~~54,00€~~

32,90€

**MÓDULO DE 7 CHAVES DE FENDA**

2.5x60, 3x100, 3.5x100, 4x125, 5.5x150, 5.5x100, 6.5x150



1/3



FG 102/45U

~~98,00€~~

59,90€

**MÓDULO DE 12 CHAVES DE FENDA**



2/3



CÓDIGO	CAPACIDADE	€/LISTA	€/PROMO
FG 102/41C	8-25mm	98,00€	57,90€
FG 102/42C	19-60mm	110,00€	59,90€



**MÓDULO DE 6 CHAVES DE FENDA**

TX10, TX15, TX20, TX25, TX27, TX30



1/3



CÓDIGO	ATTACCO	€/LISTINO	€/PROMO
FG 102/45I	Torx	66,00€	39,90€
FG 102/45L	Torx forato	67,00€	40,90€

**FG 102/45T**

~~78,00€~~

**39,90€**

**MÓDULO DE 6 CHAVES DE FENDA**

FG 22/FX6,FX7,FX8,FX10,FX13



1/3



**FG 102/48G**

~~120,00€~~

**72,90€**

**MÓDULO DE PONTAS DE 10MM**



1/3



**FG 102/50F**

~~76,00€~~

**45,90€**

**MÓDULO DE CHAVES MACHOS HEXAGONAIS**

FG 142/2, 2.5, 3, 4, 5, 6



1/3



**FG 102/50G**

~~76,00€~~

**45,90€**

**MÓDULO DE CHAVES MACHOS TORX**

FG 143/TX10, TX15, TX20, TX25, TX27, TX30



1/3



**FG 102/56C**

~~125,00€~~

**79,90€**

**MÓDULO FERRAMENTAS DE PERCUSSÃO**

FG 132/500, FG 136/40, FG 126/SN1, FG 126/SN3



1/3

**FG 102/60D**

~~58,00€~~

**36,90€**

**MÓDULO DE FERRAMENTA DE MANUTENÇÃO**

FG 44/MT5, FG 50/AR, FG 48/LG, FG 79/SP4, FG 497/OP1



1/3

**FG 102/62B**

~~95,00€~~

**59,90€**

**MÓDULO 5 LIMAS MEIO-MURÇAS**

FG 80/8AR, FG 80/8AM, FG 80/8AP, FG 80/8AT, FG 80/8AQ



1/3

**FG 102/65B**

~~66,00€~~

**41,90€**

**MÓDULO 2 ALICATES**

FG 80/8AR, FG 80/8AM, FG 80/8AP, FG 80/8AT, FG 80/8AQ  
FG 58/B240, FG 69/CJ250



1/3

**FG 102/VA1**

~~15,00€~~

**8,90€**

**MÓDULO PORTA OBJECTOS**



1/3



FG 122V/AS217

2.594,50€

1.099,00€

CARRO DE FERRAMENTAS FG 122 DE 6 GAVETAS COM 217 FERRAMENTAS EM MÓDULOS DE BORRACHA



CÓDIGO

FG 122V/AS217	FG 122D/AS217	FG 122B/AS217	FG 122R/AS217
---------------	---------------	---------------	---------------

**SORTIDO 217 FERRAMENTAS**



1º GAVETA

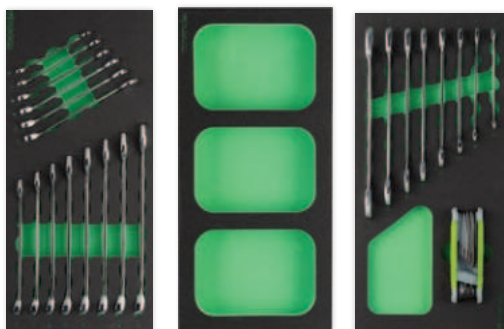

- FG 100/03G: Módulo rígido 14 laves boca/ lunetas poligonales
- FG 100/VA1: Módulo rígido porta-objectos
- FG 100/03E: Módulo 8 chaves de bocas + jogo de 9 chaves sextavadas

2º GAVETA

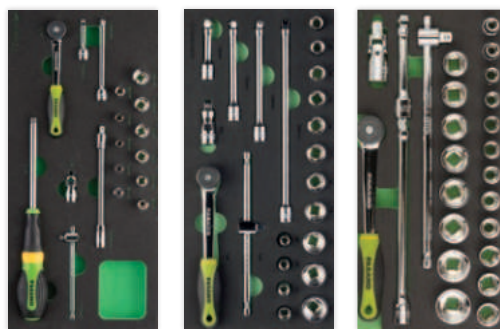

- FG 100/17: Módulo 18 ferramentas de 1/4"
- FG 100/19: Módulo chaves de caixas 6PT
- FG 100/21B: Módulo de chave de caixa 1/2" 8-32mm + acessórios

3º GAVETA



- FG 100/39XT: Módulo 3 alicates
- FG 100/48E: Módulo 98 inserções de 1/4" + 2 suportes de inserção e espaço vazio
- FG 100/65B: Módulo de alicates

4º GAVETA



- FG 100/45F: Módulo 6 chaves de fenda PH
- FG 100/45G: Módulo de 7 chaves de fenda
- FG 100/56C: Módulo de percussão

**TOP SUPERIOR EM BORRACHA COM ACABAMENTO EM CARBONO 3D**





**FG 100V/AS224**

~~2.878,00€~~ **1.199,00€**

**CARRO DE FERRAMENTAS FG 100 DE 7 GAVETAS COM 224 FERRAMENTAS EM MÓDULOS DE BORRACHA**



**CÓDIGO**

FG 100V/AS224	FG 100B/AS224	FG 100R/AS224	FG 100D/AS224	FG 100W/AS224
---------------	---------------	---------------	---------------	---------------

**SORTIDO 224 FERRAMENTAS**

**1º GAVETA**



- FG 100/03G: Módulo rígido 14 llaves boca/ lunetas poligonales
- FG 100/17E: Módulo 65 herramientas de 1/4"
- FG 100/21B: Módulo de chave de caixa 1/2" 8-32mm + acessórios

**2º GAVETA**

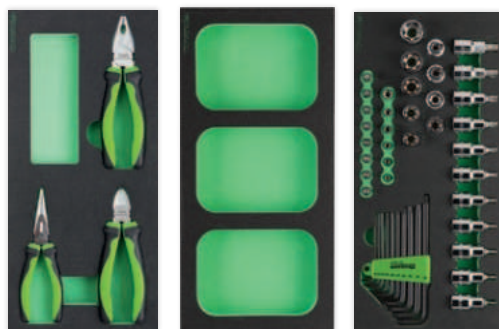

- FG 100/39XT: Módulo 3 alicates
- FG 100/VA1: Módulo rígido porta-objectos
- FG 100/21TX: Módulo rígido 44 ferramentas torx

**3º GAVETA**



- FG 100/45I: Módulo 6 chaves de fenda Torx
- FG 100/45D: Módulo 6 chaves de fenda SL e PH
- FG 100/48G: Módulo 52 puntas de 10mm

**4º GAVETA**

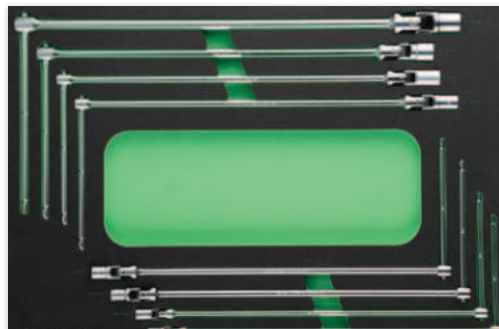

- FG 100/10C: Módulo 8 chaves em T hexagonais 7-19mm

**PRATELEIRA SUPERIOR EM ABS**





FG 122V/AS283

3.567,00€

1.349,00€

CARRO DE FERRAMENTAS FG 122 DE 7 GAVETAS COM 283 FERRAMENTAS EM MÓDULOS DE BORRACHA



CÓDIGO

FG 122V/AS283	FG 122D/AS283	FG 122B/AS283	FG 122R/AS283
---------------	---------------	---------------	---------------

SORTIDO 283 FERRAMENTAS



1º GAVETA

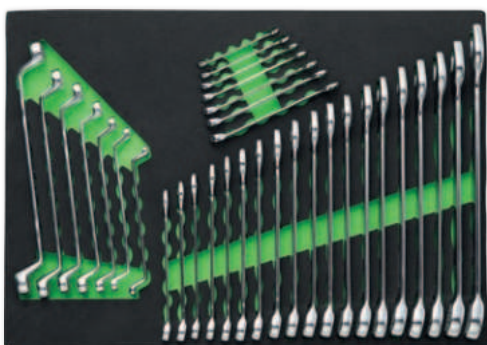

FG 100/03M: Módulo de chaves combinadas poligonais e dupla curvatura

2º GAVETA



-FG 100/21F: Módulo 1/4", 1/2", 3/8" chaves de caixa hexagonais e acessórios

3º GAVETA



-FG 100/39F: Módulo chaves para parafusos, alicates, y pontas

4º GAVETA

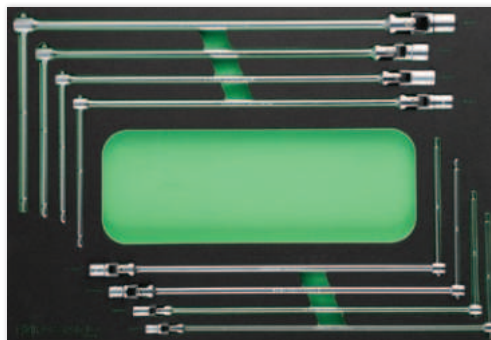

- FG 100/10C: Módulo 8 chaves em T hexagonais 7-19mm

MÓDULOS DE BORRACHA COM GAVETA COMPLETA





**FG 100V/AS413**

~~4.812,80€~~ **1.399,00€**

**FG 100 CARRO DE FERRAMENTAS DE 7 GAVETAS COM 413 FERRAMENTAS EM MÓDULOS DE BORRACHA**



**CÓDIGO**

FG 100V/AS413	FG 100B/AS413	FG 100R/AS413	FG 100D/AS413	FG 100W/AS413
---------------	---------------	---------------	---------------	---------------

**SORTIDO 413 FERRAMENTAS**



**1° GAVETA**

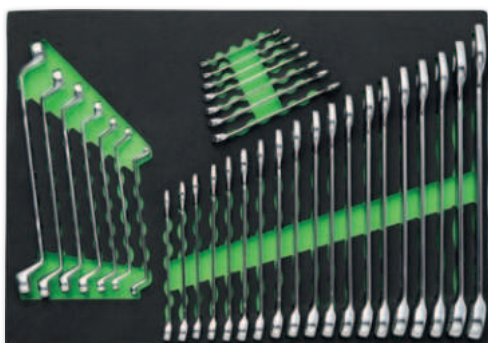

-FG 100/03M: Módulo de chaves combinadas poligonais e dupla curvatura

**2° GAVETA**



-FG 100/21F: Módulo 1/4", 1/2", 3/8" chaves de caixa hexagonais e acessórios

**3° GAVETA**



-FG 100/81G: Módulo chaves de ponta 1/4" e 1/2"

**4° GAVETA**

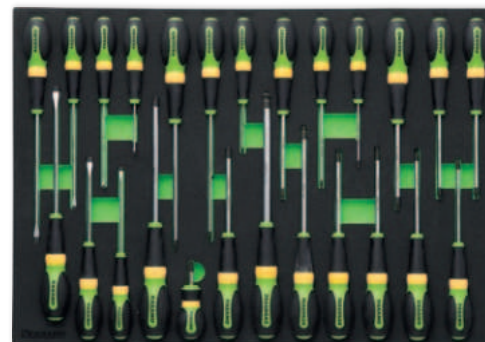

-FG 100/45R: Módulo chaves parafusos de fenda, ph, hex, esféricas y torx

**5° GAVETA**



-FG 100/39E: Módulo de alicates e pontas





FG 100V/AS230

3.571,50€

1.399,00€

FG 100 CARRO DE FERRAMENTAS DE 7 GAVETAS COM 230 FERRAMENTAS EM MÓDULOS DE BORRACHA



CÓDIGO

FG 100V/AS230	FG 100B/AS230	FG 100R/AS230	FG 100D/AS230	FG 100W/AS230
---------------	---------------	---------------	---------------	---------------

SORTIDO 230 FERRAMENTAS

1º GAVETA



- FG 100/03G: Módulo rígido 14 llaves boca/ lunetas poligonales
- FG 100/03L: Módulo 6 chaves boca/lunetas mm
- FG 100/03E: Módulo 8 chaves de bocas + jogo de 9 chaves sextavadas

2º GAVETA

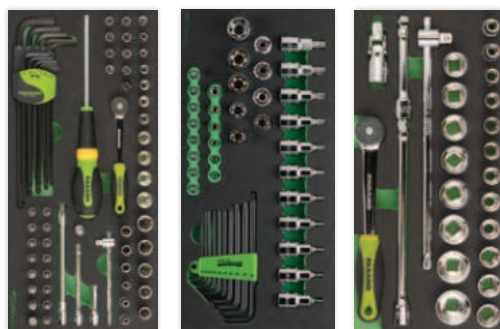

- FG 100/17E: Módulo 65 herramientas de 1/4"
- FG 100/21TX: Módulo rígido 44 ferramentas torx
- FG 100/21B: Módulo de chave de caixa 1/2" 8-32mm + acessórios

3º GAVETA



- FG 100/81F: Módulo de inserção sextavado e XZN 1/2"
- FG 100/65B: Módulo de alicates
- FG 100/42C: Módulo 4 alicates de freios

4º GAVETA



- FG 100/39XT: Módulo 3 alicates
- FG 100/45D: Módulo 6 chaves de fenda SL e PH
- FG 100/45I: Módulo 6 chaves de fenda Torx

5º GAVETA



- FG 100/10D: Módulo 12 chaves em t hexagonais 7-19mm





**FG 122V/AS402**

~~4.933,40€~~ **1.499,00€**

**CARRO DE FERRAMENTAS FG 122 DE 7 GAVETAS  
COM 402 FERRAMENTAS EM MÓDULOS DE BORRACHA**



**CÓDIGO**

FG 122V/AS402	FG 122D/AS402	FG 122B/AS402	FG 122R/AS402
---------------	---------------	---------------	---------------

**SORTIDO 402 FERRAMENTAS**



**1º GAVETA**

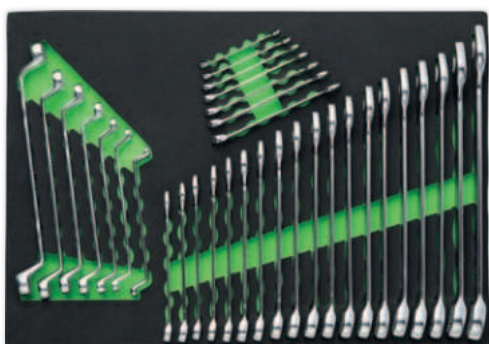

FG 100/03M: Módulo de chaves combinadas poligonais e dupla curvatura

**2º GAVETA**



-FG 100/21F: Módulo 1/4", 1/2", 3/8" chaves de caixa hexagonais e acessórios

**3º GAVETA**



-FG 100/81G: Módulo chaves de ponta 1/4" e 1/2"

**4º GAVETA**



-FG 100/39F: Módulo chaves para parafusos, alicates, y puntas

**5º GAVETA**

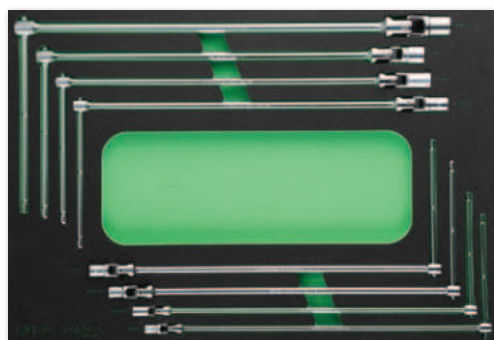

- FG 100/10C: Módulo 8 chaves em T hexagonais 7-19mm





FG 100V/AS382

3.824,00€

1.499,00€

FG 100 CARRO DE FERRAMENTAS DE 7 GAVETAS COM 382 FERRAMENTAS EM MÓDULOS DE BORRACHA



CÓDIGO

FG 100V/AS382	FG 100B/AS382	FG 100R/AS382	FG 100D/AS382	FG 100W/AS382
---------------	---------------	---------------	---------------	---------------

SORTIDO 382 FERRAMENTAS

1° GAVETA



- FG 100/03G: Módulo rígido 14 llaves boca/ lunetas poligonales
- FG 100/03L: Módulo 6 chaves boca/lunetas mm
- FG 100/03E: Módulo 8 chaves de bocas + jogo de 9 chaves sextavadas

2° GAVETA

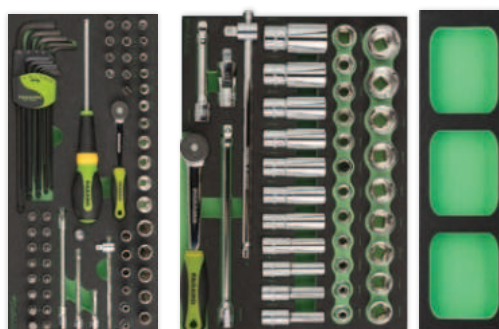

- FG 100/17E: Módulo 65 herramientas de 1/4"
- FG 100/21H: Módulo chaves de caixas 6PT
- FG 100/VA4: Módulo porta objetos

3° GAVETA



- FG 100/21TX: Módulo rígido 44 ferramentas torx
- FG 100/81F: Módulo de inserção sextavado e XZN 1/2"
- FG 100/82B: Módulo chaves de pontas RIBE

4° GAVETA



- FG 100/56C: Módulo de percussão
- FG 100/39XT: Módulo 3 alicates
- FG 100/42C: Módulo 4 alicates de freios

5° GAVETA

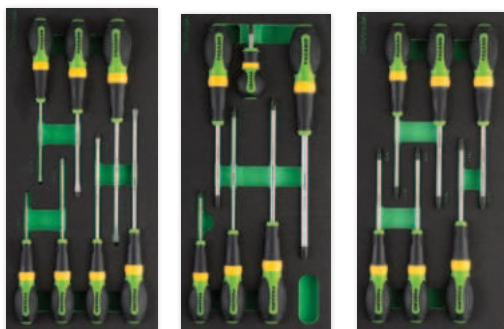

- FG 100/45G: Módulo de 7 chaves de fenda
- FG 100/45F: Módulo 6 chaves de fenda PH
- FG 100/45I: Módulo 6 chaves de fenda Torx

6° GAVETA



- FG 100/48E: Módulo 98 inserções de 1/4" + 2 suportes de inserção e espaço vazio
- FG 100/50E: Módulo de chaves machos hexagonais e Torx





**FG 100VD/AS355**

~~4.193,80€~~ **1.599,00€**

**CARRO DE FERRAMENTAS FG 100 BI COLOR DE 7 GAVETAS COM 355 FERRAMENTAS EM MÓDULOS DE BORRACHA**



FG 100VD/AS355 FG 100VW/AS355 FG 100BW/AS355 FG 100RY/AS355 FG 100CW/AS355 FG 100MA/AS355 FG 100RB/AS355  
FG 100DP/AS355 FG 100DW/AS355 FG 100BY/AS355 FG 100BD/AS355 FG 100RD/AS355 FG 100GW/AS355 FG 100RW/AS355



**SORTIDO 355 FERRAMENTAS**

**1° GAVETA**

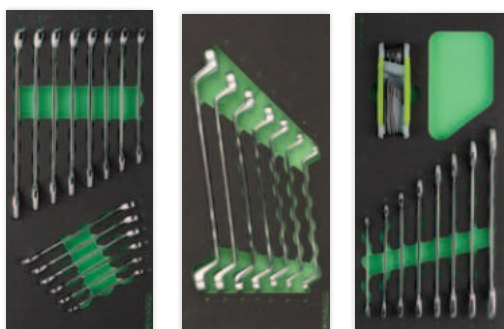

- FG 100/03G: Módulo rígido 14 llaves boca/ lunetas poligonales
- FG 100/07C: Módulo 7 chaves de luneta com curvatura
- FG 100/03E: Módulo 8 chaves de bocas + jogo de 9 chaves sextavadas

**2° GAVETA**

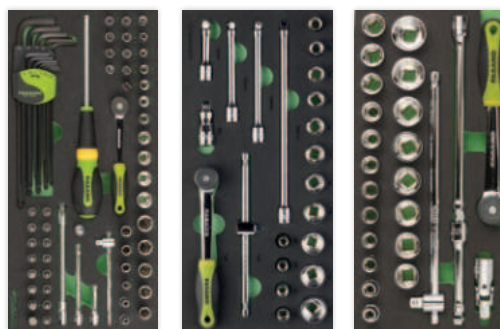

- FG 100/17E: Módulo 65 ferramentas de 1/4"
- FG 100/19: Módulo chaves de caixas 6PT
- FG 100/21B: Módulo de chave de caixa 1/2" 8-32mm + acessórios

**3° GAVETA**



- FG 100/21TX: Módulo rígido 44 ferramentas torx
- FG 100/81F: Módulo de inserção sextavado e XZN 1/2"
- FG 100/82B: Módulo chaves de pontas RIBE

**4° GAVETA**

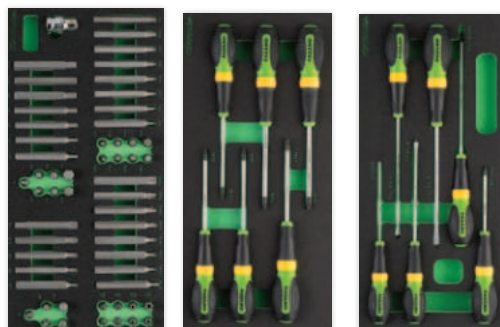

- FG 100/48G: Módulo 52 pontas de 10mm
- FG 100/45I: Módulo 6 chaves de fenda Torx
- FG 100/45D: Módulo 6 chaves de fenda SL e PH

**5° GAVETA**



- FG 100/65B: Módulo 2 alicates
- FG 100/39XT: Módulo 3 alicates
- FG 100/42C: Módulo 4 alicates de freios

**6° GAVETA**

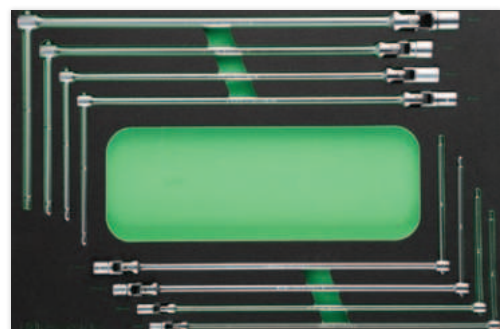

- FG 100/10C: Módulo de 8 chaves T de junta hexagonal 7-19mm
- FG 85/S31: Jogo de bits de 1/4" + adaptador de suporte de bits de 1/4" x 1/4"



FG 124V/AS322

3.926,50€

1.599,00€

CARRO DE FERRAMENTAS FG 124 DE 7 GAVETAS  
COM 322 FERRAMENTAS EM MÓDULOS DE BORRACHHA



CÓDIGO

FG 124V/AS322

FG 124D/AS322

FG 124B/AS322

FG 124R/AS322

SORTIDO 322 FERRAMENTAS



1º GAVETA



- FG 100/03G: Módulo rígido 14 laves boca/ lunetas poligonales
- FG 100/03L: Módulo 6 chaves boca/lunetas mm
- FG 100/VA4: Módulo porta objetos
- FG 100/21H: Módulo chaves de caixas 6PT

2º GAVETA

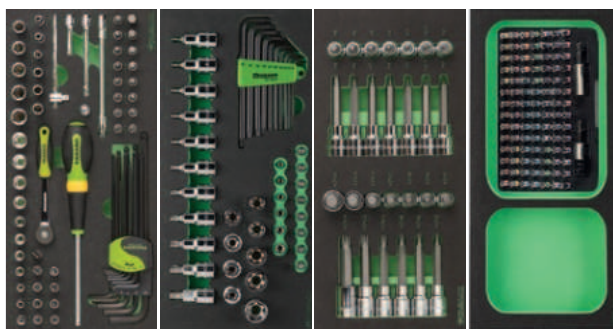

- FG 100/17E: Módulo 65 ferramentas de 1/4"
- FG 100/21TX: Módulo rígido 44 ferramentas torx
- FG 100/81F: Módulo de inserção sextavado e XZN 1/2"
- FG 100/48E: Módulo 98 inserções de 1/4" + 2 suportes de inserção e espaço vazio

3º GAVETA



- FG 100/42C: Módulo 4 alicates de freios
- FG 100/39XT: Módulo 3 alicates
- FG 100/45D: Módulo 6 chaves de fenda SL e PH
- FG 100/45I: Módulo 6 chaves de fenda Torx

4º GAVETA

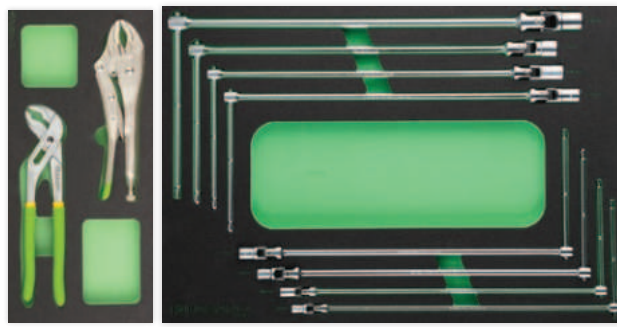

- FG 100/65B: Módulo de alicates
- FG 100/10C: Módulo 8 chaves em T hexagonais 7-19mm

PUXADOR DE AÇO  
INOXIDÁVEL

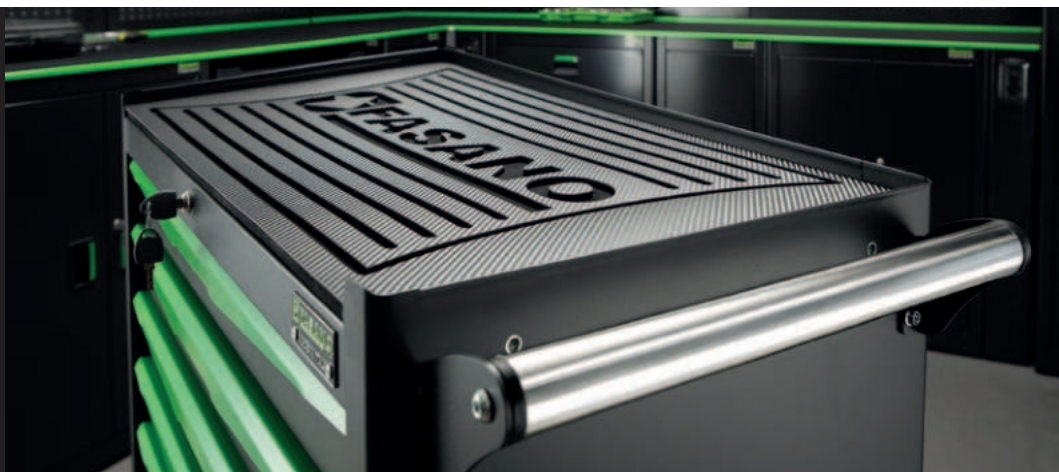



**FG 162V/AS288**

~~5.942,50€~~ **2.799,00€**

**CARRO DE FERRAMENTAS FG 162 DE 14 GAVETAS COM 288 FERRAMENTAS EM MÓDULOS DE BORRACHA**



**CÓDIGO**

FG 162V/AS288	FG 162B/AS288	FG 162R/AS288	FG 162D/AS288
---------------	---------------	---------------	---------------

**SORTIDO 288 FERRAMENTAS**

**1º GAVETA**

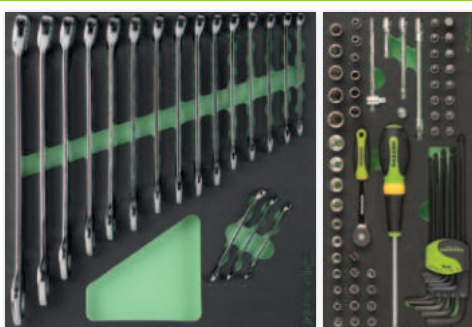

- FG 100/03H: Módulo 18 chaves boca/lunetas mm
- FG 100/17E: Módulo 65 ferramentas de 1/4"

**2º GAVETA**

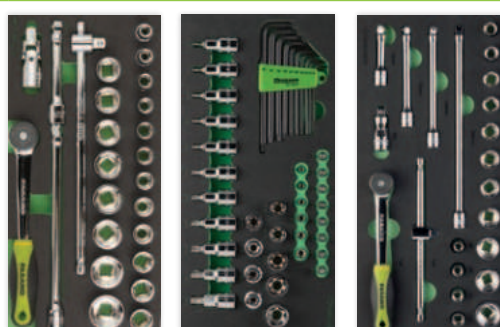

- FG 100/21B: Módulo de chave de caixa 1/2" 8-32mm + acessórios
- FG 100/21TX: Módulo rígido 44 ferramentas torx
- FG 100/19: Módulo chaves de caixas 6PT

**3º GAVETA**

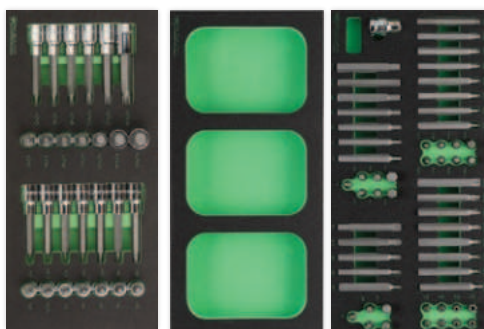

- FG 100/81F: Módulo de inserção sextavado e XZN 1/2"
- FG 100/VA1: Módulo rígido porta-objectos
- FG 100/48G: Módulo 52 puntas de 10mm

**4º GAVETA**

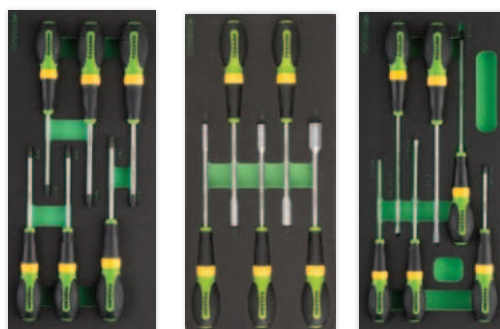

- FG 100/45I: Módulo 6 chaves de fenda Torx
- FG 100/45T: Módulo 5 chaves de fendas sextavadas
- FG 100/45D: Módulo 6 chaves de fenda SL e PH

**5º GAVETA**



- FG 100/65B: Módulo 3 alicates
- FG 100/39XT: Módulo 3 alicates
- FG 100/42C: Módulo 4 alicates de freios

**6º GAVETA**

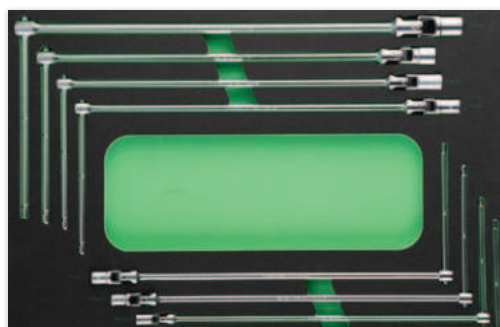

- FG 100/10C: Módulo 8 chaves em T hexagonais 7-19mm



FG 104V/AS284

4.269,00€

1.599,00€

CARRO DE FERRAMENTAS FG 104 DE 7 GAVETAS  
COM 284 FERRAMENTAS EM MÓDULOS DE BORRACHA



CÓDIGO

FG 104V/AS284

FG 104B/AS284

FG 104R/AS284

FG 104D/AS284

SORTIDO 284 FERRAMENTAS

1º GAVETA



- FG 100/03G: Módulo rígido 14 llaves boca/ lunetas poligonales
- FG 100/17E: Módulo 65 herramientas de 1/4"
- FG 100/21TX: Módulo rígido 44 ferramentas torx
- FG 100/45F: Módulo 6 chaves de fenda Phillips

2º GAVETA



- FG 100/45I: Módulo 6 chaves de fenda Torx
- FG 100/45T: Módulo 5 chaves de fendas sextavadas
- FG 100/56C: Módulo de percussão
- FG 100/81F: Módulo de inserção sextavado e XZN 1/2"

3º GAVETA

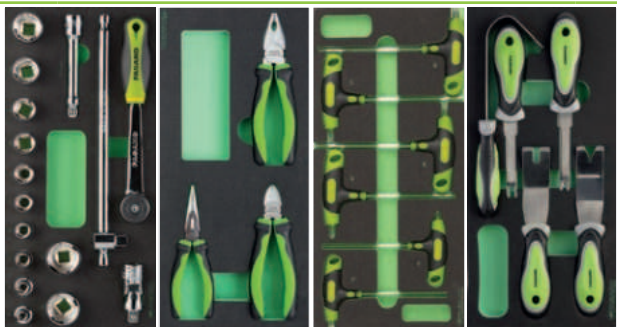

- FG 100/21M: Módulo 16 chaves de caixas 6PT
- FG 100/39XT: Módulo 3 alicates
- FG 100/50G: Módulo de chaves machos Torx
- FG 100/68: Módulo 5 extractores de cavilhas

4º GAVETA



- FG 100/52A: Módulo 8 extractores de cavilhas
- FG 100/52B: Módulo 26 ferramenta de corte para carroçaria
- FG 100/VA4: Módulo porta objetos
- FG 100/52C: Módulo 5 ferramenta para janelas e vidros

5º GAVETA



- FG 100/52D: Módulo 10 raspadores em nylon
- FG 100/52E: Módulo 5 cunhas em plástico
- FG 100/52F: Módulo 5 raspadores em aço
- FG 100/52G: Módulo 5 ferramentas de desmontar

6º GAVETA



- FG 100/52H: Módulo ferramentas para carróçaria
- FG 100/VA1: Módulo porta objetos





**FG 102V/AS335**

~~4.470,00€~~ **1.499,00€**

**CARRO DE FERRAMENTAS FG 102 DE 6 GAVETAS  
COM 335 FERRAMENTAS EM MÓDULOS DE BORRACHA**



**CÓDIGO**

FG 102D/AS335	FG 102B/AS335	FG 102R/AS335	FG 102V/AS335
---------------	---------------	---------------	---------------

**SORTIDO 335 FERRAMENTAS**



**1º GAVETA**

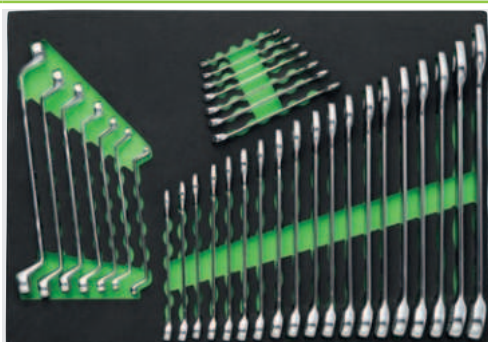

-FG 100/03M: Módulo de chaves combinadas poligonais e dupla curvatura

**2º GAVETA**



-FG 100/21F: Módulo 1/4", 1/2", 3/8" chaves de caixa hexagonais e acessórios

**3º GAVETA**



-FG 100/39F: Módulo chaves para parafusos, alicates, y pontas

**4º GAVETA**



-FG100/95B: Módulo 41 Ferramentas para pneus

**5º GAVETA**



-FG100/95C: Módulo 41 ferramentas para pneus





FERRAMENTAS ESSENCIAIS PARA LIDAR COM OS NOVOS DESAFIOS DO FUTURO

# THE HYBRID REVOLUTION

26 KIT DE FERRAMENTAS ISOLADAS, COMPLETO COM CAPACETE DIELECTRICO E LUVAS DIELECTRICAS 1000 V

IDEAL PARA INTERVENÇÕES EM VEÍCULOS ELÉCTRICOS E HÍBRIDOS



CÓDIGO	TAMANHO DA LUYA	€/LISTA	€/PROMO
FG 603/S28A	TAMANHO 9	1.048,50€	539,00€
FG 603/S28B	TAMANHO 10	1.048,50€	539,00€



**FG 100V/AS56**

~~2.950,70€~~ **1.499,00€**

**FG 100 CARRO DE FERRAMENTAS DE 6 GAVETAS COM UM SORTIDO DE 56 FERRAMENTAS ISOLADAS EM MÓDULOS DE BORRACHA**



**CÓDIGO**

FG 100V/AS56	FG 100B/AS56	FG 100R/AS56	FG 100D/AS56	FG 100W/AS56
--------------	--------------	--------------	--------------	--------------

**SORTIDO 56 FERRAMENTAS ISOLADAS**

1º GAVETA

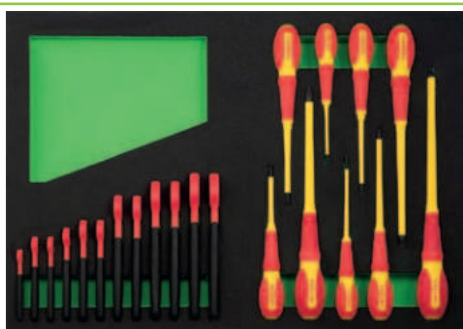

**FG 100/03-IS: Módulo chaves de boca simples e chaves para parafusos isoladas**  
 - Chaves de boca simples isoladas 7-19mm  
 - Chaves para parafusos de fenda 2.5x75mm, 3x100mm, 5.5x125mm, 6.5x150mm, 8x175mm  
 - Chaves para parafusos Phillips PH0x60, PH1x80, PH2x100, PH3x150

2º GAVETA



**FG 100/21-IS: Módulo chaves de caixa 1/2" y acessórios isolados**  
 - Chaves de caixa 1/2" 10-32mm  
 - Chaves de ponta 1/2" baixos y longos 4-10mm  
 - Acessórios de 1/2"

3º GAVETA

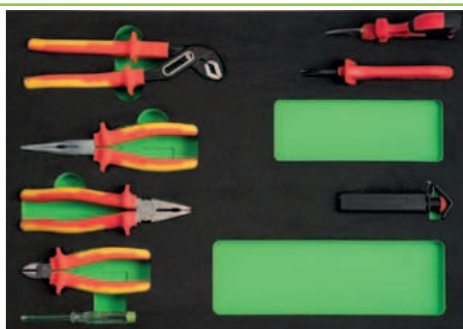

**FG 100/39-IS: Módulo alicates e ferramentas de corte**  
 - Alicates isoladas  
 - Tesoura isoladas  
 - Navalha de descarnar cabo  
 - Ferramenta para descarnar cabo

**FG 603/TA1**

~~278,00€~~ **159,00€**

**TAPETE ISOLANTE 1.000V**  
 Dimensões 1.000 x 1.000 x 3 mm





## CARROS E BANCOS

### MÓDULO 14 CHAVES BOCA/LUNETAS MM

FG 600/B6,7,8,9,10,11,12,13,14,15,16,17,18,19mm

1/3



CÓDIGO	CHIAVE	€/LISTINO	€/PROMO
FG 100/03G	FG 600/B	160,00€	89,90€
FG 100/03G-A	FG 600/A	170,00€	99,90€

### MÓDULO 6 CHAVES BOCA/LUNETAS MM

FG 600/B21,22,24,27,30,32mm

1/3



CÓDIGO	CHIAVE	€/LISTINO	€/PROMO
FG 100/03L	FG 600/B	158,00€	89,90€
FG 100/03L-A	FG 600/A	168,00€	99,90€

### MÓDULO 18 CHAVES BOCA/LUNETAS MM

FG 600/B6,7,8,10,11,12,13,14,16,17,18,19,21,22,24,27,30,32mm

2/3



CÓDIGO	CHIAVE	€/LISTINO	€/PROMO
FG 100/03H	FG 600/B	295,00€	179,00€
FG 100/03H-A	FG 600/A	320,00€	189,00€

FG 100/03E

~~98,00€~~

59,90€

### MÓDULO 8 CHAVES DE BOCAS

FG 602/B6x7,8x9,10x11,12x13,14x15,16x17,18x19,20x22 mm + FG 139C/FS

1/3

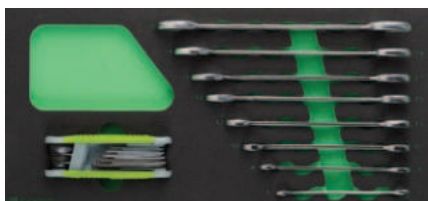

FG 100/03F

~~110,00€~~

69,00€

### MÓDULO 5 CHAVES DE BOCAS

FG 602/B21x23,24x26,25x28,27x29,30x32 mm

1/3



FG 100/07C

~~112,00€~~

65,90€

### MÓDULO 7 CHAVES DE LUNETA CURVADAS

FG 615/B6x7,8x9,10x11,12x13,14x15,16x17,18x19mm

1/3

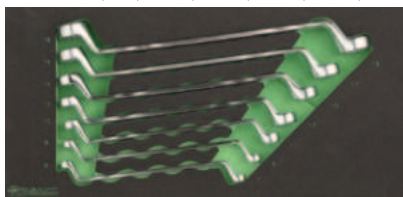

FG 100/07D

~~160,00€~~

95,90€

### MÓDULO 5 CHAVES DE LUNETA CURVADAS

FG 615/B20x22,21x23,24x27,25x28,30x32mm

1/3



FG 100/08C

~~250,00€~~

159,00€

### MÓDULO 8 CHAVES COM ROQUETE

FG 605/B8,10,11,12,13,14,15,16,17,18,19mm

1/3

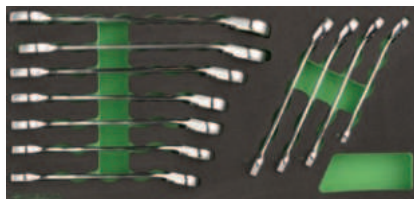

FG 100/10C

~~390,00€~~

249,00€

### MÓDULO 8 CHAVES EM T HEXAGONAIS

FG 618/A7,8,10,11,13,14,17,19 mm

1/1

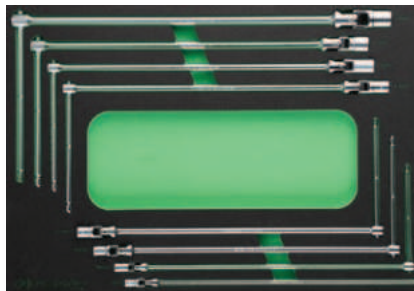



**FG 100/10D**

~~570,00€~~

**349,00€**

**MÓDULO 12 CHAVES EM T HEXAGONAIS**  
FG 618/A7, 8,10,11,12,13,14,15,16,17,18,19 mm



1/1

**FG 100/17**

~~145,00€~~

**79,90€**

**MÓDULO CHAVES DE CAIXAS 6PT**  
4-14mm



1/3

1/4"

**FG 100/17E**

~~290,00€~~

**169,00€**

**MÓDULO CHAVES DE CAIXAS 6PT**



1/3

1/4"

**FG 100/18**

~~295,00€~~

**179,00€**

**MÓDULO CHAVES DE CAIXAS 6PT**



1/3

3/8"

**FG 100/19**

~~230,00€~~

**139,00€**

**MÓDULO CHAVES DE CAIXAS 6PT**  
9-19mm

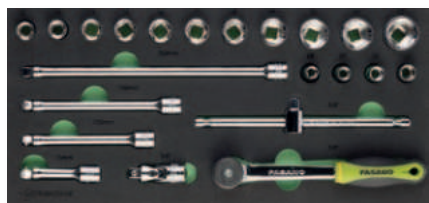

1/3

3/8"

**MÓDULO CHAVES DE CAIXAS 6PT**  
10-23mm



1/3

1/2"

CÓDIGO	ATAQUE	€/LISTINO	€/PROMO
FG 100/21B	Sextavado	250,00€	149,00€
FG 100/21C	Poligonale	250,00€	149,00€

**MÓDULO CHAVES DE CAIXAS 6PT**  
10-23mm

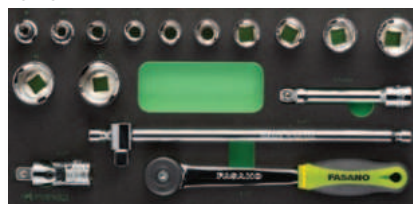

1/3

1/2"

CÓDIGO	ATAQUE	€/LISTINO	€/PROMO
FG 100/21M	Sextavado	170,00€	99,00€
FG 100/21D	Poligonale	170,00€	99,00€

**FG 100/21H**

~~440,00€~~

**269,00€**

**MÓDULO CHAVES DE CAIXAS 6PT**  
Tomadas curtas: 8-32 mm (exceto 25 mm)  
Tomadas longas: 10-32 mm

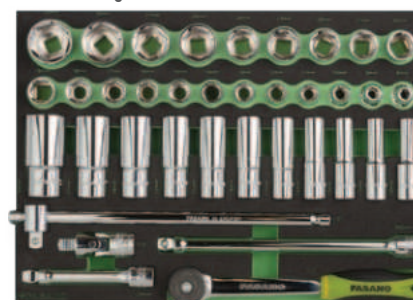

2/3

1/2"

**FG 100/21TX**

~~270,00€~~

**159,00€**

**MÓDULO 44 FERRAMENTAS TORX**

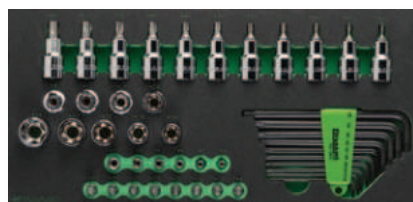

1/3

1/4"

1/2"

**FG 100/81F**

~~200,00€~~

**119,00€**

**MÓDULO CHAVES DE PONTAS**  
FG 150/H2-H8, FG 150L/H2-H8, FG 150/M5-M16,  
FG 150L/M5-M14

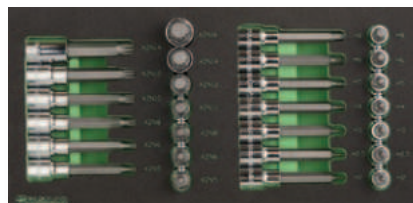

1/3

1/4"

1/2"



FG 100/23C

~~220,00€~~

129,00€

**MÓDULO CHAVES DE CAIXAS DE IMPACTO**

FG 628/C10, 11, 12, 13, 14, 15, 16, 17, 18, 19, 21, 22, 23, 24, 25, 26, 27, 30, 32mm

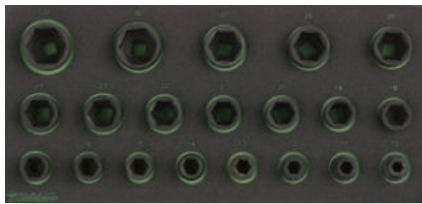

FG 100/65C

~~136,00€~~

86,90€

**MÓDULO DE ALICATES**

FG 70/CJ250 - FG 58/A240 - FG 49/HE250



FG 100/23B

~~360,00€~~

219,00€

**MÓDULO CHAVES DE CAIXAS DE IMPACTO**

FG 628/L10, 11, 12, 13, 14, 15, 16, 17, 18, 19, 21, 22, 23, 24, 25, 27, 29, 30, 32mm



FG 100/45D

~~69,00€~~

39,90€

**MÓDULO DE 6 CHAVES DE FENDA**

FG 22/3x100, 4x125, 5.5x200, 6.5x150, FG 22/PH1x80, PH2x150



FG 100/39XT

~~110,00€~~

66,90€

**MÓDULO 3 ALICATES**

FG 59/XT180 - FG 61/XT160 - FG 63/XT160

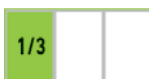
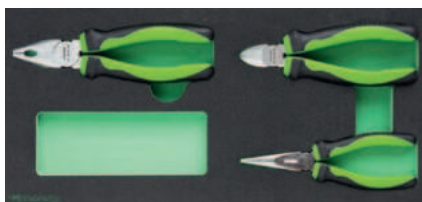

FG 100/45E

~~84,00€~~

49,90€

**MÓDULO DE 8 CHAVES DE FENDA**

3x100, 4x125, 5.5x150, 6.5x150, 6.5x38, PH1x80, PH2x150, PH2x38



**MÓDULO 4 ALICATES DE FREIOS**

FG 51/140, FG 52/140, FG 53/140, FG 54/140



FG 100/45F

~~70,00€~~

41,90€

**MÓDULO DE 6 CHAVES DE FENDA**

PH0x60, PH1x150, PH2x100, PH2x150, PH3x150, PH2x38



CÓDIGO	CAPACIDADE	€/LISTINO	€/PROMO
FG 100/41C	8-25mm	113,00€	66,90€
FG 100/42C	19-60mm	118,00€	73,90€

FG 100/65B

~~93,50€~~

54,90€

**MÓDULO DE ALICATES**

FG 58/B240, FG 69/CJ250



FG 100/45G

~~70,00€~~

41,90€

**MÓDULO DE 7 CHAVES DE FENDA**

2.5x60, 3x100, 3.5x100, 4x125, 5.5x150, 5.5x100, 6.5x150





**FG 100/45I**

~~85,00€~~

**49,90€**

**MÓDULO DE 6 CHAVES DE FENDA**  
TX10, TX15, TX20, TX25, TX27, TX30



1/3



**FG 100/50F**

~~90,00€~~

**53,90€**

**MÓDULO DE CHAVES MACHOS HEXAGONAIS**  
FG 142/2, 2.5, 3, 4, 5, 6

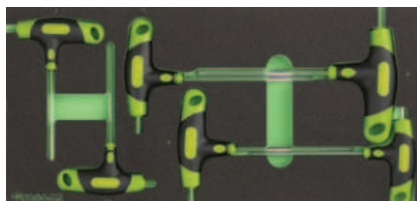

1/3



**FG 100/45T**

~~88,00€~~

**52,90€**

**MÓDULO DE 5 CHAVES DE FENDA**  
FG 22/FX6, FX7, FX8, FX10, FX13

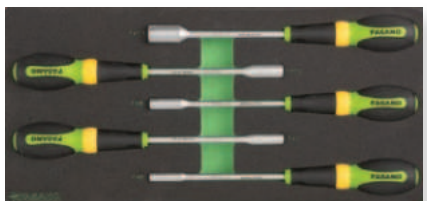

1/3



**FG 100/50G**

~~90,00€~~

**53,90€**

**MÓDULO DE CHAVES MACHOS TORX**  
FG 143/TX10, TX15, TX20, TX25, TX27, TX30

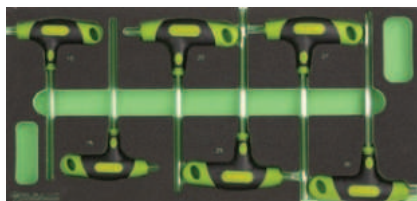

1/3



**FG 100/45H**

~~80,00€~~

**49,00€**

**MÓDULO DE 5 CHAVES DE FENDA**  
FG 22/2.5x300, 4x400, 5.5x400, FG 22/PH1x400, PH2x400

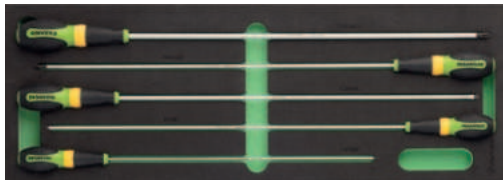

1/2



**FG 100/56C**

~~142,00€~~

**89,90€**

**MÓDULO DE PERCUSSÃO**  
FG 132/500, FG 136/40 - FG 126/SN1, FG 126/SN3



1/3

**FG 100/48G**

~~130,00€~~

**79,90€**

**MÓDULO DE PONTAS DE 10MM**

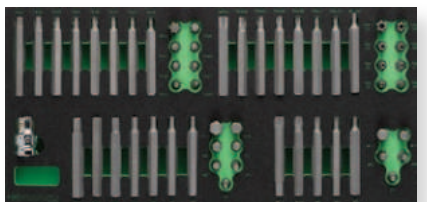

1/3



**FG 100/54**

~~188,00€~~

**119,00€**

**MÓDULO FERRAMENTAS DE MEDIÇÃO**  
FG 95/CA, FG 188/2, FG 95/M1, FG 81/PT1, FG 44/MT5



1/3

**FG 100/51H**

~~145,00€~~

**89,00€**

**MÓDULO DE CHAVES MACHOS HEXAGONAIS**  
FG 621/H2, 2.5, 3, 4, 5, 6, 8mm

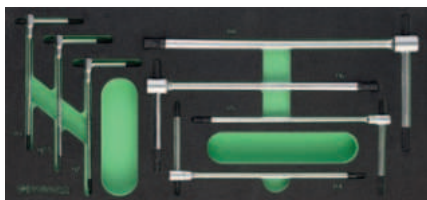

1/3



**FG 100/76C**

~~275,00€~~

**169,00€**

**OS PLUGUES DO FILTRO DE ÓLEO E AS CHAVES SE FORMAM**  
FG 176/F01 - FG 176/RE - FG 175/S15



1/3



# NEW

## MÓDULOS DE BORRACHA GAVETA COMPLETA

TERMOFORMADOS SORTIDOS COM AS FERRAMENTAS ESPECÍFICAS DE UMA GAMA DE PRODUTOS



## IMPRESSÃO BI-COLOR

CÓDIGO DE FERRAMENTA GRAVADO A LASER, PARA QUE POSSA ENCONTRAR TUDO O QUE PRECISA NUM RELANCE E POUPAR TEMPO.



### FG 100/03M

MÓDULO DE CHAVES COMBINADAS POLIGONAIS E POLIGONAIS DE DUPLA CURVATURA

33 PEÇAS

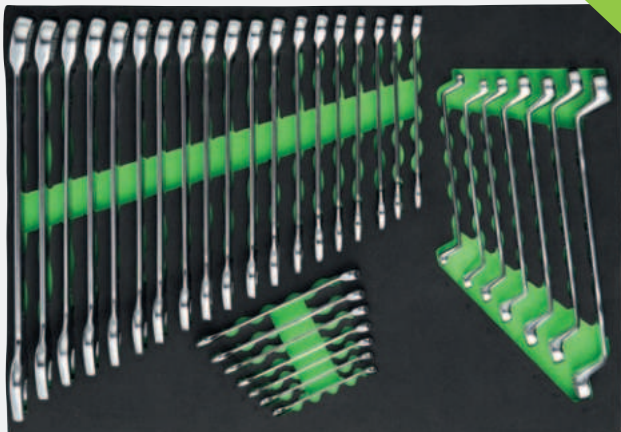

#### FG 600/B

Chaves poligonais de boca  
6, 7, 8, 9, 10, 11, 12, 13, 14, 15, 16, 17, 18, 19, 20, 21, 22, 23, 24, 25, 26, 27, 28, 29, 30, 32



#### FG 615/B

Chaves de luneta com curvatura profunda  
6x7, 8x9, 10x11, 12x13, 14x15, 16x17, 18x19



565,00€

279,00€

### FG 100/45R

MÓDULO CHAVES PARA PARAFUSOS DE FENDA, PHILLIPS, HEXAGONAIS ESFÉRICAS Y TORX

25 PEÇAS

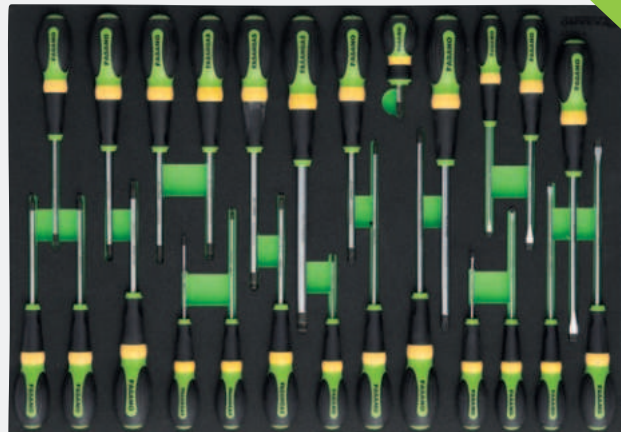

#### FG 22/PH

Chave de fenda para parafusos de perfil Phillips  
0x60, 1x150, 2x100, 2x150, 3x150

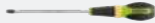

#### FG 22/PH

Chave de fenda para parafusos de perfil Phillips - Série Stubby  
2x30



#### FG 22/

Chave para parafusos de perfil de fenda  
2.5x60, 3x100, 3.5x100, 4x125, 5.5x150, 5.5x100, 6.5x150



#### FG 22/TX

Chave de fenda para parafusos de perfil TORX  
10, 15, 20, 25, 27, 30



#### FG 22/H

Chave hexagonais de extremidade esférica  
2.5, 3, 4, 5, 6, 8



276,40€

149,00€



**FG 100/39F**  
MÓDULO CHAVES PARA PARAFUSOS, ALICATES, Y PONTAS

**128**  
PEÇAS



**FG 22/PH**  
Chave de fenda para parafusos de perfil Phillips  
1x150, 2x100

**FG 22/**  
Chave para parafusos de perfil de fenda  
3x100, 4x125, 5.5x100

**FG 22/TX**  
Chave de fenda para parafusos de perfil TORX  
10, 15, 20, 25, 27, 30

**FG 59/XT180**  
Alicate universales  
180mm

**FG 63/XT160**  
Alicate de corte diagonal  
160mm

**FG 51/180**  
Alicate de freios exteriores  
180mm

**FG 53/180**  
Alicate de freios interiores  
180mm

**FG 139**  
Chaves machos hexagonais com extremidade esférica  
1.5, 2, 2.5, 3, 4, 4.5, 5, 5.5, 6, 7, 8, 10

**FG 85/S100**  
Jogo 98 pontas 1/4" + 2 porta pontas  
PH 0, 1, 2, 3; PZ 0, 1, 2, 3; Tri-Wing 1, 2, 3, 4, 6, 8, 10; XZN 5, 6, 8;  
TX 8, 9, 10, 15, 20, 25, 27, 30, 40, 45; S 0, 1, 2, 3;  
TX 8, 10, 15, 20, 25, 27, 30, 35, 40; SL 3, 4, 4.5, 5, 5.5, 6, 6.5, 7;  
H 1.5, 2, 2.5, 3, 4, 5, 5.5, 6, 1/16, 5/64, 3/32, 7/64, 1/8, 9/64,  
5/32, 3/16, 7/32, 1/4;  
HTR 2, 2.5, 3, 4, 5, 6, 5/64, 3/32, 7/64, 1/8, 9/64, 5/32; SP 4, 6, 8, 10;  
SP 5/32, 3/16, 1/4 + 2 porta pontas 1/4"

**FG 88/P14**  
Porta pontas com pega bi-material  
258mm

**432,00€** **239,00€**

**FG 100/39E**  
MÓDULO DE ALICATES Y PONTAS

**122**  
PEÇAS



**FG 59/XT180**  
Alicate universal  
180mm

**FG 63/XT160**  
Alicate de corte diagonal  
160mm

**FG 61/XT160**  
Alicate de pontas rectas  
160mm

**FG 69/CJ250**  
Alicate de pressão, maxilas côncavas  
250mm

**FG 58/B240**  
Alicate ajustável com charneira sobreposta  
240mm

**FG 85/S100**  
Jogo 98 pontas 1/4" + 2 porta pontas  
PH 0, 1, 2, 3; PZ 0, 1, 2, 3; Tri-Wing 1, 2, 3, 4, 6, 8, 10; XZN 5, 6, 8;  
TX 8, 9, 10, 15, 20, 25, 27, 30, 40, 45; S 0, 1, 2, 3;  
TX 8, 10, 15, 20, 25, 27, 30, 35, 40; SL 3, 4, 4.5, 5, 5.5, 6, 6.5, 7;  
H 1.5, 2, 2.5, 3, 4, 5, 5.5, 6, 1/16, 5/64, 3/32, 7/64, 1/8, 9/64,  
5/32, 3/16, 7/32, 1/4;  
HTR 2, 2.5, 3, 4, 5, 6, 5/64, 3/32, 7/64, 1/8, 9/64, 5/32; SP 4, 6, 8, 10;  
SP 5/32, 3/16, 1/4 + 2 porta pontas 1/4"

**FG 88/P14**  
Porta pontas com pega bi-material

**FG 139**  
Chaves machos hexagonais com extremidade esférica  
1.5, 2, 2.5, 3, 4, 4.5, 5, 5.5, 6, 7, 8, 10

**FG 51/180**  
Alicate de retenes exteriores  
180mm

**FG 52/180**  
Alicate de freios exteriores com pontas curvas 90°  
180mm

**FG 53/180**  
Alicate de freios interiores  
180mm

**FG 54/180**  
Alicate de freios interiores com pontas curvas 90°  
180mm

**475,40€** **269,00€**



# CARROS E BANCOS

## FG 100/21F

MÓDULO 1/4", 1/2", 3/8" CHAVES DE CAIXA HEXAGONAIS E ACESSÓRIOS

115  
PEÇAS



**FG 624/E - FG 624E/L**  
Chaves de caixa de 1/4" - séries normal e longa  
4, 5, 6, 7, 8, 9, 10, 11, 12, 13, 14



**FG 624/CR14**  
Roquete reversível, quadra 1/4"-72 dentes



**FG 624/PA**  
Extensões quadras macho fêmea de 1/4" angulares  
50, 100mm



**FG 624/PR150**  
Extensões quadras macho fêmea de 1/4"  
150mm



**FG 624/ES14**  
Cabo t corredeço, quadra de 1/4"



**FG 624/SN14**  
Cardam com quadras macho e fêmea de 1/4"



**FG 624/GR14C**  
Quadrado macho de 1/4" com pega



**FG 147/H**  
Chaves de caixa com ponta hexagonais 1/4"  
2,5, 3, 4, 5, 6, 7, 8, 10



**FG 147/PH**  
Chaves de caixa com ponta de perfil Phillips - 1/4"  
1, 2, 3, 4



**FG 147/TX**  
Chaves de caixa com ponta de perfil Torx 1/4"  
9, 10, 15, 20, 25, 27, 30, 40



**FG 147/SL**  
Chaves de caixa com ponta de perfil de fenda 1/4"  
4, 5,5, 6,5, 8, 10



**FG 139/L**  
Chaves machos hexagonais com extremidade esférica - série longa  
1,5, 2, 2,5, 3, 4, 4,5, 5, 5,5, 6, 7, 8, 10



**FG 624B/PA**  
Extensões quadras macho fêmea de 3/8" angulares  
75, 125, 150, 250



**FG 624/SN38**  
Cardam com quadras macho e fêmea de 3/8"



**FG 624/ES38**  
Cabo t corredeço, quadra de 3/8"



**FG 624/CR38**  
Roquete reversível, quadra 3/8"-72 dentes



**FG 624/B**  
Chave de caixa 3/8" hexagonal  
8, 9, 10, 11, 12, 13, 14, 15, 16, 17, 18, 19, 21, 22, 23



**FG 625/A**  
Chave de caixa 1/2" hexagonal  
8, 9, 10, 11, 12, 13, 14, 15, 16, 17, 18, 19, 20, 21, 22, 23, 24, 25, 26, 27, 30, 32



**FG 625/PA**  
Extensões quadras macho fêmea de 1/2" angulares  
125, 250

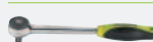

**FG 625/CR12**  
Roquete reversível, quadra 1/2"-72 dentes



**FG 625/SN12**  
Cardam com quadras macho e fêmea de 1/2"



**FG 625/ES12**  
Cabo t corredeço, quadra de 1/2"

1.030,00€

599,00€

## FG 100/81G

MÓDULO CHAVES DE PONTA 1/4" E 1/2"

118  
PEÇAS



**FG 150/H**  
Chaves de ponta de perfil macho hexagonal 1/2"  
2, 2,5, 3, 4, 5, 6, 8



**FG 150L/H**  
Chaves de ponta de perfil macho hexagonal 1/2" - inserção longa  
2, 2,5, 3, 4, 5, 6, 8



**FG 150/M**  
Chaves de ponta XZN 1/2"  
5, 6, 8, 10, 12, 14, 16

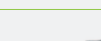

**FG 150L/M**  
Chaves de ponta XZN 1/2" - inserção longa  
5, 6, 8, 10, 12, 14



**FG 624/TX**  
Chave de caixa 1/4" Torx  
4, 5, 6, 7, 8, 10



**FG 625/TX**  
Chave de caixa 1/2" Torx  
8, 10, 12, 14, 16, 18, 20, 22, 24



**FG 147/TX**  
Chaves de caixa com ponta de perfil Torx 1/4"  
9, 10, 15, 20, 25, 27, 30, 40



**FG 150/TX**  
Chaves de ponta de perfil Torx 1/2"  
10, 15, 20, 25, 27, 30, 40, 45, 50, 55, 60



**FG 138/C**  
Chaves macho Torx  
TX9, TX10, TX15, TX20, TX25, TX27, TX30, TX40, TX45, TX50



**FG 150/R**  
Chaves de porta de perfil RIBE 1/2"  
4, 5, 6, 7, 8, 9, 10, 11, 12, 13, 14



**FG 150L/R**  
Chaves de ponta de perfil RIBE 1/2" série longa  
4, 5, 6, 7, 8, 9, 10, 11, 12, 13, 14



**FG 147/H**  
Chaves de caixa com ponta hexagonal 1/4"  
2,5, 3, 4, 5, 6, 7, 8, 10



**FG 147/PH**  
Chaves de caixa com ponta de perfil Phillips - 1/4"  
1, 2, 3, 4



**FG 147/PT**  
Chaves de caixa com ponta 5 nervuras e furo central - 1/4"  
1, 2, 3, 4



**FG 147/SL**  
Chaves de caixa com ponta de perfil de fenda 1/4"  
4, 5,5, 6,5, 8, 10



**FG 624/CS14**  
Cabo articulado com punho, quadra 1/4"

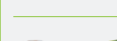

**FG 625/CS12**  
Cabo articulado com punho, quadra 1/2"

1.366,00€

499,00€



**FG 100/56D**

MÓDULO DE FERRAMENTAS DE MANUTENÇÃO GERAL

15  
PEÇAS



**FG 132/500**  
Martelos para mecânico com cabo de resina 500 Gr

**FG 136/30**  
Martelos com batentes plásticos intercambiável 30 Ø/mm

**FG 126/SN**  
Escopros planos série nervurada 125mm, 200mm

**FG 95/CA**  
Paquímetro leitura cinquagesimal 150mm

**FG 80/8AR**  
Limas meio-murças com punhos - redondo 8"

**FG 80/8AM**  
Limas meio-murças com punhos - medio redondo 8"

**FG 80/8AP**  
Limas meio-murças com punhos - plana 8"

**FG 80/8AQ**  
Limas meio-murças com punhos - triangular 8"

**FG 80/8AT**  
Limas meio-murças com punhos - quadrado 8"

**FG 50/AR**  
Serra de recortes compacta com pega Hoja 140mm

**FG 48/LG**  
X-acto com lâmina longa 16.7mm

**FG 497/OP2**  
Oleador pressurizado com palhinha de latão embutida 80cc

**FG 44/MT5**  
Fitas métricas, fita em aço 5 metri

**FG 79/SP4**  
Escova com fios de aço ondulados revestidos a latão 270mm

~~364,00€~~ 229,00€

**FG 100/95B**

MÓDULO DE FERRAMENTAS PARA LOJA DE PNEUS

18  
PEÇAS



**FG 536/2**  
Chaves dinamométricas reversível, para aperto direito-1/2" 40-200Nm

**FG 628/R**  
Chaves de porcas para rodas 17,19,21mm

**FG 198/PE**  
Alicate de remoção de pesos de equilíbrio das rodas

**FG 186P/S4**  
4 Colheres de nylon

**FG 628R/L**  
Chaves de porcas para rodas - modelo longo 17,19,21mm

**FG 126/P500**  
Ferros de desmontar rodas de liga leve

**FG 628/R**  
Chaves de porcas para rodas 16.5x17.5,18.5x19.5,21x21.5,22x22.5,27x27.5

~~684,50€~~ 399,00€

**FG 100/95C**

MÓDULO DE FERRAMENTAS PARA LOJA DE PNEUS

41  
PEÇAS



**FG 628/R**  
Chaves de porcas para rodas 17,19,21mm

**FG 628/C**  
Chave de caixa 1/2" hexagonal reforçado 10,11,12,13,14,15,16,17,18,19,20,21,22,23,24,25,26,27,30,32mm

**FG 628/L**  
Chave de caixa 1/2" hexagonais reforçado - série longa 10,13,14,17,19,21,22,24

**FG 152/RH**  
Chave de ponta reforçada hexagonais de 1/2" 5,6,7,8,10,12,14,17,19

**FGA 309**  
Chave de impacto 1/2"

~~818,50€~~ 449,00€



FG 128/2

~~700,00€~~

**349,00€**

**BANCADA THE TRABALHO 2.0MT**

Prateleira superior em chapa de aço galvanizado de 2 mm

Peso total: 59,5 kg

Capacidade de carga estática: 2000 Kg

Dimensões: 2000x670x880 mm



FG 128/D2

~~950,00€~~

**479,00€**

**BANCADA THE TRABALHO 2.0MT EQUIPADO COM 2 GAVETAS**

Prateleira superior em chapa de aço galvanizado de 2 mm

Peso total: 74,5 kg

Capacidade de carga estática: 2000 Kg

Dimensões: 2000x670x880 mm



FG 128/D2



FG 128/B2



FG 128/R2



FG 129/2

~~850,00€~~

**449,00€**

**BANCADA THE TRABALHO 2.0MT**

Prateleira superior em chapa de aço galvanizado de 3 mm

Peso total: 77 kg

Capacidade de carga estática: 2000 Kg

Dimensões: 2000x745x880 mm



FG 129/D2

~~1.100,00€~~

**579,00€**

**BANCADA THE TRABALHO 2.0MT EQUIPADO COM 2 GAVETAS**

Prateleira superior em chapa de aço galvanizado de 3 mm

Peso total: 92 kg

Capacidade de carga estática: 2000 Kg

Dimensões: 2000x745x880 mm



FG 129/D2



FG 129/B2



FG 129/R2





FG 129/1

~~550,00€~~

**289,00€**

**BANCADA THE TRABALHO 1.0MT**

Prateleira superior em chapa de aço galvanizado de **3 mm**  
Prateleira inferior em chapa de aço fornecida de série  
2 montantes  
Disposições para fixação ao solo  
Estrutura pintada com tinta epoxi  
Peso total: 58 Kg  
Capacidade de carga estática: 2000 Kg  
Dimensões: 1000x745x880 mm



FG 129/D1

~~690,00€~~

**359,00€**

**BANCADA THE TRABALHO 1.0MT EQUIPADO COM 1 GAVETAS**

Prateleira superior em chapa de aço galvanizado de **3 mm**  
Prateleira inferior em chapa de aço fornecida de série  
2 montantes  
Disposições para fixação ao solo  
Estrutura pintada com tinta epoxi  
Peso total: 64.5 Kg  
Capacidade de carga estática: 2000 Kg  
Dimensões: 1000x745x880 mm



FG 129/D1



FG 129/B1



FG 129/R1



FG 129/1.5

~~650,00€~~

**339,00€**

**BANCADA THE TRABALHO 1.5MT**

Prateleira superior em chapa de aço galvanizado de **3 mm**  
Prateleira inferior em chapa de aço fornecida de série  
2 montantes  
Disposições para fixação ao solo  
Estrutura pintada com tinta epoxi  
Peso total: 77 Kg  
Capacidade de carga estática: 2000 Kg  
Dimensões: 1500x745x880 mm

FG 129/D1.5

~~790,00€~~

**419,00€**

**BANCADA THE TRABALHO 1.5MT EQUIPADO COM 1 GAVETAS**

Prateleira superior em chapa de aço galvanizado de **3 mm**  
Prateleira inferior em chapa de aço fornecida de série  
2 montantes  
Disposições para fixação ao solo  
Estrutura pintada com tinta epoxi  
Peso total: 83.5 Kg  
Capacidade de carga estática: 2000 Kg  
Dimensões: 1500x745x880 mm



FG 129/D1.5



FG 129/B1.5



FG 129/R1.5





## CARROS E BANCOS



FG 137/D1.5

~~1.400,00€~~

**739,00€**

### BANCADA ESPECIAL 1.5MT COM TANQUE DE COLETA E RODAS GIRATÓRIAS

Peso total: 90 Kg  
Dimensões: 1500x745x880 mm  
Prateleira microperfurada



FG 137/D1.5

FG 137/B1.5

FG 137/R1.5

FG 131/D2

~~1.700,00€~~

**899,00€**

### BANCADA PROFISIONAL - 2.0M EQUIPADA COM 5 GAVETAS

Peso total: 121.5 Kg  
Dimensões: 2000x670x920 mm



FG 131/D2

FG 131/B2

FG 131/R2

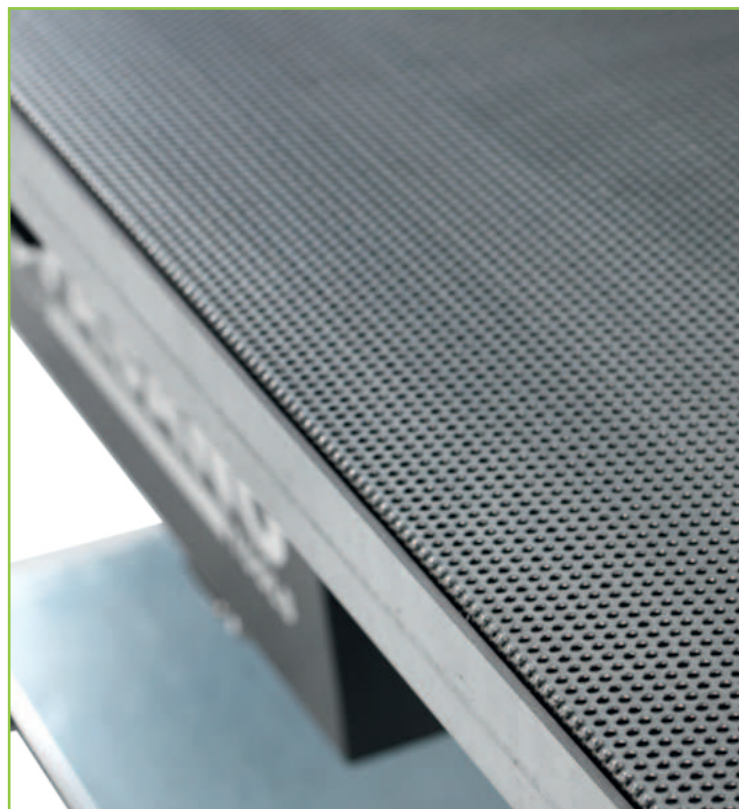





**FG 107/A**

~~165,00€~~

**89,00€**

**CARRO PORTA FERRAMENTAS**

Chapa de aço: 1mm  
 2 rodízios fixos e 2 rodízios giratórios com travão (Ø100mm)  
 Profundidade da prateleira: 7,8 cm  
 Capacidade de carga estática distribuída por 3 prateleiras: 90 kg  
 Dimensões: 730x380x780  
 Peso kg: 16,4



**FG 106/B**

~~320,00€~~

**189,00€**

**CARRO PORTA FERRAMENTAS**

Dimensões: 460x930x885 mm  
 Chapa de aço de 1,5 mm  
 Rodas montadas em suporte de placa rotativa com unidade de rolamento duplo de esferas  
 2 fixas, 1 giratória + 1 roda giratória com travão (Ø100mm)  
 Peso total: 22 Kg



**FG 106/C**

~~420,00€~~

**229,00€**

**CARRO PORTA FERRAMENTAS**

Dimensões: 560x1000x950 mm  
 Chapa de aço 2,0 mm  
 Rodas montadas em suporte de placa giratória com unidade de rolamento duplo de esferas  
 2 fixas, 1 giratória + 1 rodízio giratório com travão (Ø125mm)  
 Peso total: 44 Kg



MADE IN ITALY



PRODUÇÃO  
100% MADE IN ITALY

# MOBILIÁRIO FG 118 TÉCNICO



PINTURA  
SEMIBRILHO

## OS DETALHES QUE FAZEM A DIFERENÇA

TOMADAS COM LIGAÇÕES STANDARD, SCHUKO E USB  
CÓMODAS COM GAVETAS TOTALMENTE EQUIPADAS  
PODE SER ABERTO E EQUIPADO COM MATS  
EM BORRACHA RESISTENTE A RISCOS

- ARMÁRIOS COM 4 PRATELEIRAS INTERNAS E DOBRADIÇAS DE FECHO AUTOMÁTICO
- REVESTIMENTO SUPERIOR EM POLICARBONATO E NOVO ACABAMENTO RESISTENTE A RISCOS
- MÓVEIS DE PAREDE COM PORTAS EQUIPADAS COM PISTÕES A GÁS







**FG 118/C030V**

~~7.670,00€~~

**3.399,00€**

**CONFIGURAÇÃO TÉCNICA DO MOBILIÁRIO 3050MM**

FG 118V/205A: Estrutura básica para configuração de 2050mm, equipada com 2 unidades de parede superiores

FG 118D/40A: Módulo fixo com portas

FG 118D/7T: Módulo móvel com 7 gavetas

FG 118/69D7: Módulo fixo com 7 gavetas

FG 118/AR1D: Armário alto com portas

FG 118/AR1D: Armário alto com portas

Dimensão mm (LxPxH): 3050x757x2000

**MADE IN ITALY**



FG 118/C030D



FG 118/C030B



FG 118/C030R



**FG 118/C02V**

~~5.840,00€~~

**2.499,00€**

## CONFIGURAÇÃO TÉCNICA DO MOBILIÁRIO 2050MM

Configuração composta por:

FG 118V/69A: Módulo de armários com 2 portas

FG 118V/7T: Gaveteiro móvel com 7 gavetas

FG 118V/40F: Módulo porta-papel com gaveta de resíduos

2 porta-ferramentas

2 tomadas fornecidas: 1 x tomada de 2 pinos 220V, 1 x tomada de 2 pinos Schuko + USB

Dimensões: 2050x757x2000 mm

**MADE IN ITALY**



FG 118/C02D



FG 118/C02B



FG 118/C02R



**FG 118/C03V**

~~6.620,00€~~

**2.899,00€**

## CONFIGURAÇÃO TÉCNICA DO MOBILIÁRIO 2550MM

Configuração composta por:

FG 118V/AR1V: Armário metálico de arrumação com 1 porta

FG 118V/69A: Módulo de armário com 2 portas

FG 118V/7T: Gaveteiro móvel com 7 gavetas

FG 118V/40F: Módulo porta-papéis com gaveta de resíduos

2 porta-ferramentas

2 tomadas fornecidas: 1 x tomada de 2 pinos 220V, 1 x tomada de 2 pinos Schuko + USB

Dimensões: 2550x757x2000 mm

**MADE IN ITALY**



FG 118/C03D



FG 118/C03B



FG 118/C03R



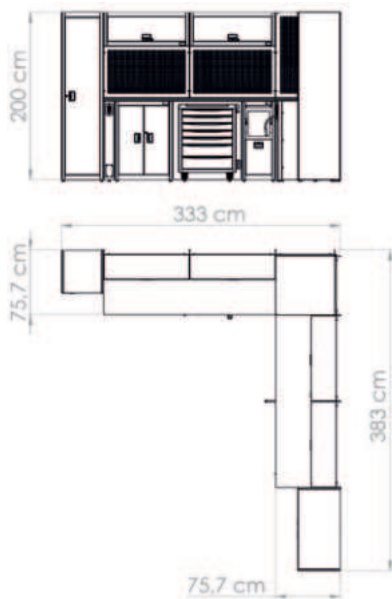

**FG 118/C022V**

**15.260,00€**

**7.899,00€**

**CONFIGURAÇÃO TÉCNICA DE MÓVEIS DE CANTO A PARTIR DE 7160**

Configuração composta por:

- FG 118/AR1V: Armário lateral de 500mm
- FG 118V69A: Módulo de armário de 2 portas
- FG 118V/7T: Módulo de gavetas móvel com 7 gavetas
- FG 118V/40F: Módulo porta-papel com gaveta de resíduos
- FG 118V/80AN: Armário de canto equipado com porta-ferramentas
- FG 118V/69E: Módulo de caixote do lixo
- FG 118M/40D: Módulo de distribuição de ar comprimido
- FG 118/69V7: Móvel de gavetas fixo com 7 gavetas
- FG 118/AR2V: Armário lateral com duas portas
- 4 armários superiores de parede equipados com pistões de gás e fechadura
- 4 porta-ferramentas
- 2 tomadas cada uma composta por 1 tomada 220V de 2 pinos, 1 tomada Schuko de 2 pinos, 1 tomada USB
- Dimensões 2500x3030x757x2000 mm

**MADE IN ITALY**



FG 118/C022D



FG 118/C022B

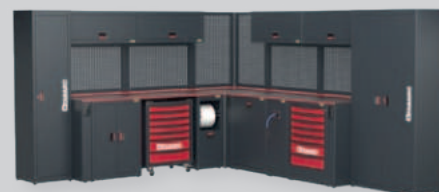

FG 118/C022R



**NEW**

**MADE IN ITALY**



**NOVO SISTEMA  
DE MOBILIÁRIO  
TÉCNICO**

**FG 117**



**NOVA CÔMODA FG 117**  
DISPONÍVEL EM 4 VARIAÇÕES DE CORES

**NOVO PLANO DE TRABALHO**

ESTANTE PINTADA EQUIPADA DE TOPO EM  
POLICARBONATO RESISTENTE A RISCOS

**DESIGN MAIS ELEGANTE E FUNCIONAL**

**COM CANTOS ARREDONDADOS**



**PRATELEIRAS  
INTERIORES**



**PINTURA DE  
CETIM MATE**



**COMPOSIÇÃO  
COMPACTO COM APENAS  
51 CM DE PROFUNDIDADE**





**NEW**



**FG 117/C024V**

~~6.000,00€~~ **2.499,00€**

**CONFIGURAÇÃO TÉCNICA DO MOBILIÁRIO 3065MM**

- FG 117V/207A: Estrutura básica equipada com 3 porta-ferramentas e 3 unidades de parede superiores
- FG 117D/7G: Gaveteiro móvel com 7 gavetas
- FG 117/68D7: Móvel de gavetas fixo com 7 gavetas
- FG 117V/68B: Módulo porta-papéis com gaveta de resíduos
- FG 117/AR2V: Armário lateral com duas portas
- Dimensões mm (LxPxH): 3065x510x2000

**MADE IN ITALY**



FG 117/C024D

FG 117/C024B

FG 117/C024R



**FG 117V/AS210**

**5.325,00€ 2.699,00€**

## CONFIGURAÇÃO TÉCNICA DO MOBILIÁRIO COM SORTIDO 210 FERRAMENTAS

FG 117V/207A: Estrutura básica equipada com 3 porta-ferramentas e 3 unidades de parede superiores

FG 117/68D7: Móvel de gavetas fixo com 7 gavetas

FG 117V/68A: Módulo de armário com 2 portas

FG 117V/68B: Módulo porta-papéis com gaveta de resíduos

FG 117/AR1V: Armário lateral com 1 portas

Sortido 210 ferramentas



FG 117D/AS210



FG 117B/AS210



FG 117R/AS210

MADE IN ITALY



1° CASSETTO



- FG 102/03G: Módulo 14 chaves boca/lunetas poligonais 6-19mm
- FG 102/03L: Módulo 6 chaves de bocas
- FG 102/21B: Módulo 25 ferramentas 1/2"

2° CASSETTO



- FG 102/17E: Módulo 18 ferramentas de 1/4"
- FG 102/19: Módulo 18 ferramentas 3/8"
- FG 102/45I: Módulo rígido 6 chaves de fenda torx

3° CASSETTO



- FG 102/39XT: Módulo 3 alicates
- FG 102/42C: Módulo rígido 4 alicates de freios
- FG 102/45D: Módulo rígido 6 chaves de fenda sl e ph

4° CASSETTO



- FG 102/56C: Módulo rígido ferramentas de percussão
- FG 102/65B: Módulo rígido 2 alicates ajustavel
- FG 102/48G: Módulo rígido 52 pontas de 10mm







**FG 117/C02V**

~~4.525,00€~~

**1.799,00€**

**CONFIGURAÇÃO TÉCNICA DO MOBILIÁRIO 2065MM**

FG 117V/207A: Estrutura básica equipada com 3 porta-ferramentas e 3 unidades de parede superiores

FG 117V/68A: Módulo de armário com 2 portas

FG 117V/7G: Gaveteiro móvel com 7 gavetas

FG 117V/68B: Módulo porta-papéis com gaveta de resíduos

Dimensões mm (LxPxH): 2070x490x2000

MADE IN ITALY



FG 117/C02D



FG 117/C02B



FG 117/C02R



**FG 117/C03V**

~~5.245,00€~~

**1.999,00€**

**CONFIGURAÇÃO TÉCNICA DO MOBILIÁRIO 2065MM + ARMÁRIO**

FG 117V/207A: Estrutura básica equipada com 3 porta-ferramentas e 3 unidades de parede superiores

FG 117V/68A: Módulo de armário com 2 portas

FG 117V/7G: Gaveteiro móvel com 7 gavetas

FG 117V/68B: Módulo porta-papéis com gaveta de resíduos

FG 117/AR1V: Armário lateral com 1 portas

Dimensões mm (LxPxH): 2565x510x2000

MADE IN ITALY



FG 117/C03D



FG 117/C03B



FG 117/C03R



FG 117/C016V

3.665,00€

1.599,00€

**CONFIGURAÇÃO TÉCNICA DO MOBILIÁRIO 1380MM + ARMÁRIO**

FG 117V/138A: Estrutura básica equipada com 2 porta-ferramentas e 2 unidades de parede superiores

FG 117V/68A: Módulo de armário com 2 portas

FG 117/68V5: Móvel de gavetas fixo com 5 gavetas

FG 117/AR1V: Armário lateral com 1 portas

Dimensões mm (LxPxH): 1875x510x2000

MADE IN ITALY



FG 117/C016D



FG 117/C016B



FG 117/C016R

FG 117/C030V

8.480,00€

3.499,00€

**CONFIGURAÇÃO TÉCNICA DE MÓVEIS DE CANTO**

FG 117V/207A: Estrutura básica equipada com 3 porta-ferramentas e 3 unidades de parede superiores

FG 117V/138A: Estrutura básica equipada com 2 porta-ferramentas e 2 unidades de parede superiores

FG 117V/68B: Módulo porta-papéis com gaveta de resíduos

FG 117V/7G: Gaveteiro móvel com 7 gavetas

FG 117/68V6: Móvel de gavetas fixo com 6 gavetas

FG 117V/68A: Módulo de armário com 2 portas

FG 117V/68A: Módulo de armário com 2 portas

Dimensões mm (LxPxH): 2566x490x2000 + 1885x490x2000



MADE IN ITALY



FG 117/C030D



FG 117/C030B



FG 117/C030R



FG 120  
**MAXI**  
>STATION<

COM A NOVA ESTAÇÃO MÓVEL  
FASANO TOOLS, O TRABALHO TORNA  
SE AINDA MAIS VERSÁTIL E FLEXÍVEL



PUXADOR DE AÇO INOXIDÁVEL



GAVETAS COM ABERTURA TOTAL

PRATELEIRA SUPERIOR  
EM AÇO COM TOP  
EM POLICARBONATO



NOVA TINTA  
SATIN MATE

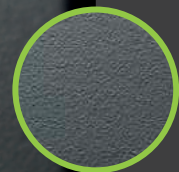

CAPAS DE  
RODAS  
DOBRÁVEIS





FG 120/C01V

2.690,00€

1.189,00€

**CONFIGURAÇÃO MAXI STATION**

Prateleira superior em aço com cobertura em policarbonato  
 Envernizamento mate enrugado  
 Pega em aço inoxidável  
 Gavetas de abertura total completo com tapetes anti-riscos e com divisórias  
 Coberturas de rodas dobráveis  
 4 rodas giratórias Ø 125mm com corpo em polipropileno e borracha vulcanizada (2 com travão)  
 Composto por:  
 FG 120V/7T - Módulo de gavetas fixo de 7 gavetas  
 FG 120V/A - Módulo fixo de uma porta  
 FG 120V/A - Módulo fixo de uma porta  
 Dimensão mm (LxPxH): 1540x460x1030



MADE IN ITALY



FG 120/C01D

FG 120/C01B

FG 120/C01R



FG 120/C02V

2.690,00€

1.249,00€

**CONFIGURAÇÃO MAXI STATION**

Prateleira superior em aço com cobertura em policarbonato  
 Envernizamento mate enrugado  
 Pega em aço inoxidável  
 Gavetas de abertura total completo com tapetes anti-riscos e com divisórias  
 Coberturas de rodas dobráveis  
 4 rodas giratórias Ø 125mm com corpo em polipropileno e borracha vulcanizada (2 com travão)  
 Composto por:  
 FG 120V/7T - Módulo de gavetas fixo de 7 gavetas  
 FG 120V/A - Módulo fixo de uma porta  
 FG 120V/B - Módulo para rolo de papel, com gaveta de lixo  
 Dimensão mm (LxPxH): 1540x460x1030



MADE IN ITALY



FG 120/C02D

FG 120/C02B

FG 120/C02R





**FG 120/C03V**

~~2.790,00€~~

**1.289,00€**

**CONFIGURAÇÃO MAXI STATION**

Prateleira superior em aço com cobertura em policarbonato  
 Envernizamento mate enrugado  
 Pega em aço inoxidável  
 Gavetas de abertura total completo com tapetes anti-riscos e com divisórias  
 Coberturas de rodas dobráveis  
 4 rodas giratórios Ø 125mm com corpo em polipropileno e borracha vulcanizada (2 com travão)  
 Composto por:  
 FG 120V/7T - Módulo de gavetas fixo de 7 gavetas  
 FG 120V/A - Módulo fixo de uma porta  
 FG 120V/C - Módulo fixo para ar comprimido  
 Dimensão mm (LxPxH) 1540x460x1030



**MADE IN ITALY**



FG 120/C03D

FG 120/C03B

FG 120/C03R



**FG 120/C04V**

~~2.960,00€~~

**1.399,00€**

**CONFIGURAÇÃO MAXI STATION**

Prateleira superior em aço com cobertura em policarbonato  
 Envernizamento mate enrugado  
 Pega em aço inoxidável  
 Gavetas de abertura total completo com tapetes anti-riscos e com divisórias  
 Coberturas de rodas dobráveis  
 4 rodas giratórios Ø 125mm com corpo em polipropileno e borracha vulcanizada (2 com travão)  
 Composto por:  
 FG 120V/7T - Módulo de gavetas fixo de 7 gavetas  
 FG 120V/B - Módulo para rolo de papel, com gaveta de lixo  
 FG 120M/E - Módulo fixo para ar comprimido + 3 enchuffs (1 shuko 16a + 2 bivalentes 16a)  
 Dimensão mm (LxPxH) 1540x460x1030



**MADE IN ITALY**



FG 120/C04D

FG 120/C04B

FG 120/C04R



**FG 120V/AS217**

~~4.204,50€~~

**1.699,00€**

## MAXI STATION FG 120 COM UM SORTIDO DE 217 FERRAMENTAS

Prateleira superior em aço com cobertura em policarbonato

Envernizamento mate enrugado

Pega em aço inoxidável

Gavetas de abertura total completo com tapetes anti-riscos e com divisórias

Coberturas de rodas dobráveis

4 rodas giratórios Ø 125mm com corpo em polipropileno e borracha vulcanizada (2 com travão)

Composto por:

FG 120V/7T - Módulo de gavetas fixo de 7 gavetas

FG 120V/A - Módulo fixo de uma porta

FG 120V/B - Módulo para rolo de papel, com gaveta de lixo

Dimensão mm (LxPxH): 1540x460x1030

Sortido 217 ferramentas



FG 120D/AS217



FG 120B/AS217



FG 120R/AS217



MADE IN ITALY

### 1° CASSETTO

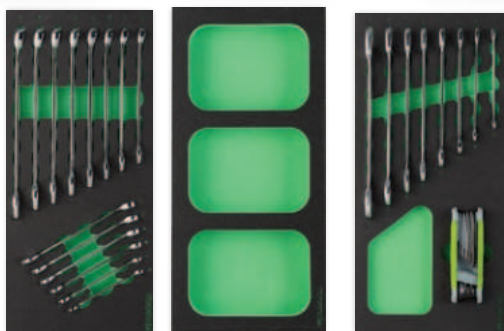

- FG 100/03G: Módulo 14 chaves boca/lunetas poligonais 6-19mm
- FG 100/VA1: Módulo rígido porta-objectos
- FG 100/03E: Módulo 8 chaves de bocas + Jogo de 9 chaves sextavadas macho

### 2° CASSETTO



- FG 100/17: Módulo 18 ferramentas de 1/4"
- FG 100/19: Módulo chaves de caixas 6PT
- FG 100/21B: Módulo 25 ferramentas 1/2"

### 3° CASSETTO



- FG 100/39XT: Módulo 3 alicate
- FG 100/48E: Módulo 98 insertos de 1/4" + 2 suportes e espaço vazio
- FG 100/65B: Módulo de alicates

### 4° CASSETTO



- FG 100/45F: Módulo 6 chaves de fenda
- FG 100/45G: Módulo de 7 chaves de fenda
- FG 100/56C: Módulo de percussão



## MAXI STATION FG 120 COM UM SORTIDO DE 217 FERRAMENTAS



**FG 120V/AS224**

~~4.468,00€~~ **1.799,00€**

**MAXI STATION FG 120 COM UM SORTIDO DE 224 FERRAMENTAS**

Prateleira superior em aço com cobertura em policarbonato  
 Envernizamento mate enrugado  
 Pega em aço inoxidável  
 Gavetas de abertura total completo com tapetes anti-riscos e com divisórias  
 Coberturas de rodas dobráveis  
 4 rodas giratórios ø 125mm com corpo em polipropileno e borracha vulcanizada (2 com travão)  
 Composto por:  
 FG 120V/7T - Módulo de gavetas fixo de 7 gavetas  
 FG 120V/A - Módulo fixo de uma porta  
 FG 120V/B - Módulo para rolo de papel, com gaveta de lixo  
 Dimensão mm (LxPxH): 1540x460x1030  
 Sortido 224 ferramentas



FG 120D/AS224



FG 120B/AS224



FG 120R/AS224



**MADE IN ITALY**

**1° CASSETTO**

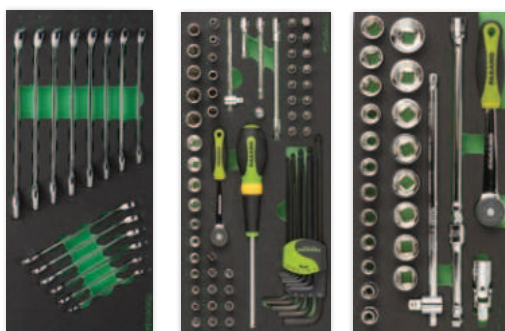

- FG 100/03G: Módulo 14 chaves boca/lunetas poligonais 6-19mm
- FG 100/17E: Módulo 65 ferramentas de 1/4"
- FG 100/21B: Módulo 25 ferramentas 1/2"

**2° CASSETTO**

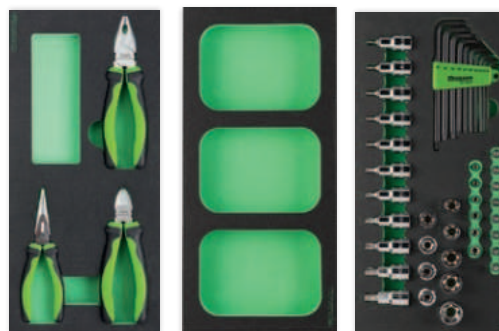

- FG 100/39XT: Módulo 3 alicate
- FG 100/VA1: Módulo rígido porta-objectos
- FG 100/21TX: Módulo rígido 44 ferramentas torx

**3° CASSETTO**

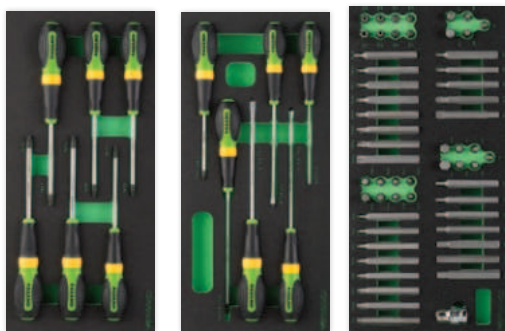

- FG 100/45I: Módulo de 6 chaves Torx
- FG 100/45D: Módulo 6 chaves de fenda SL e PH
- FG 100/48G: Módulo 52 pontas de 10mm

**4° CASSETTO**

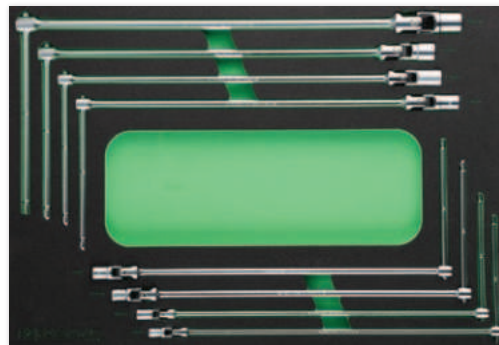

- FG 100/10C: Módulo 8 chaves em T hexagonais 7-19mm

**MAXI STATION FG 120  
 COM UM SORTIDO  
 DE 224 FERRAMENTAS**



## Mobiliário para vans!

Oferecemos aos nossos clientes a mais alta qualidade e eficiência, mesmo na estrada. O mobiliário **Fasano Tools** para carrinhas e veículos comerciais oferece a possibilidade de criar o ambiente de trabalho ideal para as suas necessidades.

Totalmente personalizável e modular, é composto por gavetas, armários, prateleiras e paredes equipadas com grelhas de ferramentas, porta-peças e uma vasta gama de acessórios.

**Tudo o que você precisa para trabalhar fora de sua própria oficina, mesmo que você sempre o carregue com você.**

O mobiliário técnico Fasano Tools dedicado aos veículos equipados adapta-se perfeitamente a todas as necessidades do trabalho diário. Escolha a cor e a composição ideais!

MADE IN ITALY

Módulos disponíveis em 3 variantes de cores

RAL 6018

RAL 5002

RAL 3001



MÓDULOS

MOBILIÁRIO PARA VANS!



ALÇAS ABS COM ALÇA ERGONÓMICA



GAVETAS COM ABERTURA TOTAL PARA MÓDULOS PORTA-FERRAMENTAS



MALAS MODULARES COM COMPARTIMENTOS SUPORTE PARA PEÇAS PEQUENAS



PORTAS DE ABERTURA TOTALMENTE EXTRAÍVEIS



BANDEJAS PLÁSTICAS PARA PEÇAS PEQUENAS



PLATAFORMAS ANTIDERRAPANTE





**FG 119V/C016**

**2.326,00**

**899,00€**

**CONFIGURAÇÃO DE MOBILIÁRIO TÉCNICO PARA VANS**

Dimensões mm: 980x400x1057

Peso kg: 61,8

Inclui (de cima para baixo)

FG 119/MRT40-9: par de montantes laterais

FG 119/RP40-92: Prateleira com divisórias amovíveis

FG 119V/C49-3: Cómada de 3 gavetas

FG 119V/C49-4: Cómada de 4 gavetas

FG 119V/BA98: móvel inferior aberto

FG 119/RI98: extensão para armários inferiores abertos ou fechados

FG 119/KS: kit de instalação

**MADE IN ITALY**



FG 119V/C016



FG 119B/C016



FG 119R/C016



**FG 119V/C012**

**2.869,00**

**1.199,00€**

**CONFIGURAÇÃO DE MOBILIÁRIO TÉCNICO PARA VANS**

Dimensões mm: 980x400x1592

Peso kg: 74,9

Inclui (de cima para baixo)

FG 119/M30-40: par de montantes laterais

FG 119/RV30-92: Prateleira com tabuleiros de plástico

FG 119/RP30-92: prateleira com divisórias amovíveis

FG 119/M40-23: pares de montantes laterais

FG 119/RP40-92: Prateleira com divisórias amovíveis

FG 119V/C49-3: Cómada de 3 gavetas

FG 119V/C49-4: Cómada de 4 gavetas

FG 119V/BA98: móvel inferior aberto

FG 119/RI98: extensão para armários inferiores abertos ou fechados

FG 119/KS: kit de instalação

**MADE IN ITALY**



FG 119V/C012



FG 119B/C012



FG 119R/C012



## MOBILIÁRIO PARA VANS



**FG 119V/C025**

**2.241,00**

**949,00€**

### CONFIGURAÇÃO DE MOBILIÁRIO TÉCNICO PARA VANS

Dimensões mm: 1225x400x1057

Peso kg: 76,2

Inclui (de cima para baixo)

FG 119/MRT40-9: par de montantes laterais

FG 119/RP40-116: Prateleira com divisórias amovíveis

FG 119V/C49-4: Cómada de 4 gavetas

FG 119V/C73-3: gaveteiro com 3 gavetas

FG 119/BVF-L122B: base alta com abertura frontal

FG 119/KS: kit de instalação

**MADE IN ITALY**



FG 119V/C025



FG 119B/C025



FG 119R/C025



**FG 119V/C022**

**2.794,00**

**1.199,00€**

### CONFIGURAÇÃO DE MOBILIÁRIO TÉCNICO PARA VANS

Dimensões mm: 1225x400x1592

Peso kg: 91,2

Inclui (de cima para baixo)

FG 119/M30-40: par de montantes laterais

FG 119/RV30-116: Prateleira com tabuleiros de plástico

FG 119/RP30-116: prateleira com divisórias amovíveis

FG 119/M40-23: pares de montantes laterais

FG 119/RP40-116: Prateleira com divisórias amovíveis

FG 119V/C49-4: Cómada de 4 gavetas

FG 119V/C73-3: gaveteiro com 3 gavetas

FG 119/BVF-L122B: base alta com abertura frontal

FG 119/KS: kit de instalação

**MADE IN ITALY**



FG 119V/C022



FG 119B/C022



FG 119R/C022





**FG 119V/C033**

**4.077,00**

**1.599,00€**

**CONFIGURAÇÃO DE MOBILIÁRIO TÉCNICO PARA VANS**

Dimensões mm: 1470x400x1360

Peso kg: 114

Inclui (de cima para baixo)

FG 119/M30-40: par de montantes laterais

FG 119/RP30-141: prateleira com divisórias amovíveis

FG 119/RV30-141: Prateleira com tabuleiros de plástico

FG 119V/C49-V1: módulo equipado com 4 caixas de peças pequenas

FG 119V/C98-3: Cómada de 3 gavetas

FG 119V/BA98: base aberta

FG 119V/C49-5B: móvel inferior com 5 gavetas

FG 119/RI98: base elevada para móveis abertos ou fechados

FG 119/KS: kit de instalação

**MADE IN ITALY**



FG 119V/C033

FG 119B/C033

FG 119R/C033



**FG 119V/C036**

**3.567,00**

**1.599,00€**

**CONFIGURAÇÃO DE MOBILIÁRIO TÉCNICO PARA VANS**

Dimensão mm (LxPxH): 1470x400x1057

Peso kg: 98,9

Inclui (de cima para baixo)

FG 119/MRT20-9 x 2: par de montantes laterais

FG 119/RP20-141 x 2: prateleira com divisórias amovíveis

FG 119M/C49-V2: módulo equipado com 4 caixas de peças pequenas

FG 119V/C98-3: Cómada de 3 gavetas

FG 119V/BA98: móvel inferior aberto

FG 119V/C49-5B: móvel inferior com 5 gavetas

FG 119/RI98: com elevação para armários inferiores abertos ou fechados

FG 119/KS: kit de instalação

**MADE IN ITALY**



FG 119V/C036

FG 119B/C036

FG 119R/C036



**FG 119V/C018**

~~2.375,00~~

**999,00€**

**CONFIGURAÇÃO DE MOBILIÁRIO TÉCNICO PARA VANS**

Dimensão mm (LxPxH): 980x400x980

Peso kg: 56,5

Inclui (de cima para baixo)

FG 119/98TL: bancada de madeira

FG 119/C49-3: Cómada de 3 gavetas

FG 119/C49-4: Cómada de 4 gavetas

FG 119V/BA98: móvel inferior aberto

FG 119/R198: elevação para armários inferiores abertos ou fechados

FG 119/KS: kit de instalação

**MADE IN ITALY**



FG 119V/C018



FG 119B/C018



FG 119R/C018

**FG 119V/C027**

~~2.390,00~~

**1.099,00€**

**CONFIGURAÇÃO DE MOBILIÁRIO TÉCNICO PARA VANS**

Dimensão mm (LxPxH): 1225x400x980

Peso kg: 71,6

Inclui (de cima para baixo)

FG 119/73TL: bancada de madeira

FG 119/49TL: bancada de madeira

FG 119/C49-4: Cómada de 4 gavetas

FG 119/C73-3: Cómada de 3 gavetas

FG 119/BVF-L122B: base alta com abertura frontal

FG 119/KS: kit de instalação

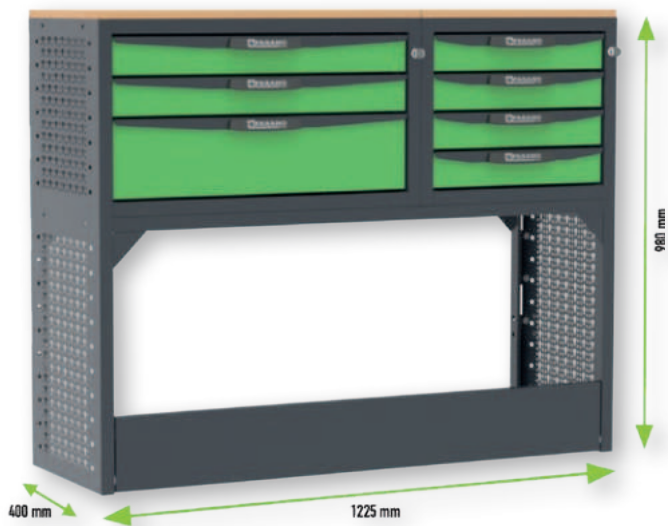

FG 119V/C027



FG 119B/C027



FG 119R/C027



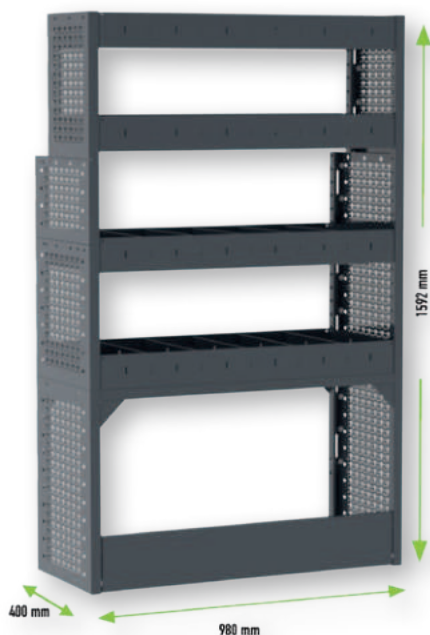

**FG 119M/C013**

~~1.493,00~~

**499,00€**

**CONFIGURAÇÃO DE MOBILIÁRIO TÉCNICO PARA VANS**

Dimensão mm (LxPxH): 980x400x1592

Peso kg: 40,4

Inclui (de cima para baixo)

FG 119/M30-40: par de montantes laterais

FG 119/RP30-92: prateleira com divisórias amovíveis

FG 119/RP30-92: Prateleira com divisórias amovíveis

FG 119/M40-23: Pares de montantes laterais

FG 119/M40-40: Pares de montantes laterais

FG 119/RP40-92: Prateleira com divisórias amovíveis

FG 119/RP40-92: Prateleira com divisórias amovíveis

FG 119/BVF-L98B: base com abertura frontal

FG 119/KS: kit de instalação

**MADE IN ITALY**



**FG 119M/C028**

~~1.573,00~~

**599,00€**

**CONFIGURAÇÃO DE MOBILIÁRIO TÉCNICO PARA VANS**

Dimensão mm (LxPxH): 1225x400x1592

Peso kg: 40,4

Inclui (de cima para baixo)

FG 119/M30-40: par de montantes laterais

2 x FG 119/RP30-141: prateleiras com divisórias amovíveis

FG 119/M40-23: pares de montantes laterais

FG 119/M40-40: Pares de montantes laterais

2 x FG 119/RP40-141: prateleiras com divisórias amovíveis

FG 119/BVF-L147B: base com painel frontal amovível

FG 119/KS: kit de instalação

**MADE IN ITALY**



**FG 119M/C037**

~~1.739,00~~

**699,00€**

**CONFIGURAÇÃO DE MOBILIÁRIO TÉCNICO PARA VANS**

Dimensão mm (LxPxH): 1470x400x1592

Peso kg: 40,4

Inclui (de cima para baixo)

FG 119/M30-40: par de montantes laterais

2 x FG 119/RP30-116: prateleiras com divisórias amovíveis

FG 119/M40-23: pares de montantes laterais

FG 119/M40-40: pares de montantes laterais

2 x FG 119/RP40-116: prateleiras com divisórias amovíveis

FG 119/BVF-L122B: base com painel frontal amovível

FG 119/KS: kit de instalação

**MADE IN ITALY**



## FERRAMENTAS ESPECIAIS PARA AUTOMOTIVE

FG 175/F074.5-8

~~50,00€~~

29,90€

CHAVE DE CAIXA PARA FILTROS DE ÓLEO FIAT, LANCIA, ALFA ROMEO  
Ø/mm: 74.5 - 8 lados



1/2"

FG 175/F084

~~57,00€~~

33,90€

CHAVES PARA FILTRO DE ÓLEO MERCEDES  
Ø/mm: 84 - 14 lados



1/2"

FG 175/HI

~~67,00€~~

39,90€

CHAVES PARA FILTRO DE ÓLEO- HYUNDAI TUCSON  
Ø/mm: 81 - 14 lados



1/2"

FG 175/OP1

~~46,50€~~

27,90€

CHAVE DE FILTRO DE ÓLEO OPEL/VAUXHALL  
Ø/mm: 74.7 - 15 lados



1/2"

FG 175/S30

~~221,50€~~

129,00€

JOGO 28 CHAVES PARA FILTRO DE ÓLEO



FG 175/S6

~~63,00€~~

39,90€

JOGO DE 6 CHAVES PARA CARTUCHOS DE FILTRO  
Conteúdo: 6pz





**FG 178/UF83**

~~35,00€~~

**20,90€**

CHAVE DE APERTO AUTOMÁTICO PARA REMOVER FILTROS DE ÓLEO

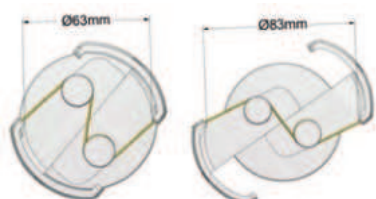

**NEW**



CHAVE DE FILTRO DE ÓLEO PARA APERTAR COM A MÃO DIREITA E ESQUERDA - MODELO PARA SERVIÇO PESADO

1/2"



CÓDIGO	ØMM	€/LISTA	€/PROMO
FG 178/UF110	80 - 110 mm	115,00€	69,00€
FG 178/UF145	104 - 145 mm	165,00€	99,00€

**FG 178/FL**

~~46,00€~~

**28,90€**

FUNIL FLEXÍVEL DE ALUMÍNIO REVESTIDO A BORRACHA



**NEW**



**FG 175/PR**

~~40,00€~~

**23,90€**

EXTENSÃO PARA CHAVES DE CAIXA PARA REMOÇÃO DE TAMPA DE ÓLEO

Com recipiente de óleo



**NEW**



**FG 175/S15**

~~135,00€~~

**79,90€**

JOGO 15 CHAVES MAGNÉTICAS PARA BUJÕES DE ÓLEO



**FG 175/S114**

~~265,00€~~

**159,00€**

FERRAMENTAS PARA REPARAÇÃO BUJÕES DE ÓLEO

- M 13x1.25
- M 13x1.5
- M 15x1.5
- M 17x1.5
- M 20x1.5
- M 22x1.5





FG 203/S20

~~370,00€~~

209,00€

**KIT PARA DETECÇÃO DE FUGAS E ENCHIMENTO RÁPIDO DE SISTEMAS DE REFRIGERAÇÃO**



FG 201/S7

~~340,00€~~

209,00€

**KIT PARA PRESSÃO NA SISTEMAS DE CIRCUITO DIESEL**

Novo modelo com bomba bidirecional



FG 176/S13

~~445,00€~~

259,00€

**APARELHO PARA O ENCHIMENTO DE ÓLEO NAS CAIXAS DE VELOCIDADES, TRANSMISSÕES, DIFERENCIAIS**

Equipado com 12 acessórios para ligação direta  
Equipado com válvula anti-retorno



TAMPAS OPCIONAIS PARA FG 203/S20

FG 203/BW1  
BMWFG 203/FO1  
FORD Fiesta  
from 2008FG 203/FO2  
FORDFG 203/OP1  
OPELFG 203/TO1  
TOYOTAFG 203/FT1  
FIAT

CÓDIGO	MARCAS	€/LISTA	€/PROMO
FG 203/BW1	BMW	36,50€	21,90€
FG 203/FO1	FORD FIESTA DAL 2008	36,50€	21,90€
FG 203/FO2	FORD	36,50€	21,90€
FG 203/FT1	FIAT	45,00€	26,90€
FG 203/OP1	OPEL	36,50€	21,90€
FG 203/TO1	TOYOTA	37,50€	22,90€

FG 203/S7

~~166,00€~~

99,00€

**FERRAMENTA PARA O PREENCHIMENTO DE DEPRESSÃO DOS CIRCUITOS DE REFRIGERAÇÃO**

Útil para uma purga perfeita devido à aspiração do circuito de arrefecimento



FG 491/200

~~38,00€~~

23,90€

**SERINGA PARA FLUIDOS**

Fornecido com 2 vedantes de substituição - Capacità 200cc

FG 491/1500

~~85,00€~~

51,90€

**SERINGA PARA ÓLEO**

Fornecido com 2 vedantes de substituição

Não adequado para combustíveis e óleos minerais - Capacità 1500cc



FG 491/DF1500

~~135,00€~~

79,90€

**SERINGA DE EXTRAÇÃO DE COMBUSTÍVEL DO CIRCUITO DIESEL**

Equipadas com adaptadores de ligação rápida - Capacità 1500cc





FG 191/S22

620,00€

389,00€

**EXTRACTOR UNIVERSAL PARA INJECTORES ELÉCTRICOS DEPLHI, BOSCH SIEMENS E DENSO**

Completo com martelo massa 4,8 kg

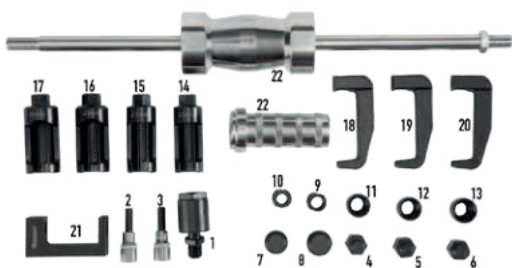
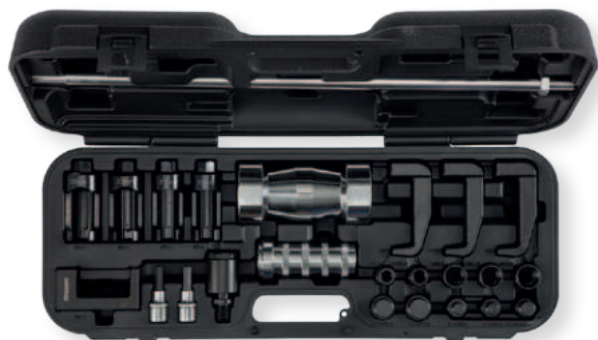

CÓDIGO	DESCRIÇÃO
FG 191/ES-SN	1- Junta de articulação universal
FG 190/EL1A	2- Ferramenta de remoção de eléctrodos electro-injectores Ø 7,5
FG 190/EL1	3- Ferramenta de remoção de eléctrodos injectores Ø 6,6
FG 191/ES-6	4- Adaptador com rosca exterior M16X1,0
FG 191/ES-7	5- Adaptador com rosca exterior M17X1
FG 191/ES-8	6- Adaptador com rosca exterior M20X1
FG 191/ES-9	7- Adaptador com rosca exterior M25X1
FG 191/ES-10	8- Adaptador com rosca externa M27X1
FG 191/ES-2	9- Adaptador com rosca interna M16X1.5
FG 191/ES-1	10- Adaptador com rosca interna M14X1.5
FG 191/ES-3	11- Adaptador com rosca interna M25X0.5
FG 191/ES-4	12- Adaptador com rosca interna M25X0,75
FG 191/ES-5	13- Adaptador com rosca interna M27X1,0
FG 190/A25	14- Casquilho para retirar a ligação eléctrica Ø 25
FG 190/A27	15- Tomada para retirar a ligação eléctrica Ø 27
FG 190/A29	16- Tomada para a remoção da ligação eléctrica Ø 29
FG 190/A30	17- Tomada para a remoção da ligação eléctrica Ø 30
FG 191/ES-11	18- Abertura do extrator de garfos 12 mm
FG 191/ES-12	19- Abertura do extrator de garfos 13,5 mm
FG 191/ES-13	20- Abertura do extrator de garfos 16 mm
FG 191/ES-14	21- Abertura do extrator de garfos 26 mm
FG 191/MI	22- Massa da alavanca 4,8 kg

FG 191/S24

470,00€

299,00€

**JOGO DE FERRAMENTAS DE EXTRAÇÃO PNEUMÁTICA PARA ELECTRO-INJECTORES BOSCH, DELPHI, SIEMENS E DENSO**

NEW



CÓDIGO	DESCRIÇÃO
FG 191/S24-1	1-Extrator
FG 191/S24-2	2-Adptador M14*1.5xM18*1.5x52L
FG 191/S24-4	4-Adptador M18*0.75xM14x66
FG 191/S24-5	5-Adptador M17*1.0xM14x66L
FG 191/S24-6	6-Adptador M10*1.5xM14x33L
FG 191/S24-7	7-Adptador M8*1.0xM14x33L
FG 191/S24-8	8-Adptador M8*1.5xM14x33L
FG 191/S24-9	9-Adptador M22*1.5xM14x33L
FG 191/S24-10	10-Adptador M20*1.5-M12*1.5(Interno)xM14x33L
FG 191/S24-11	11-Adptador M14*1.5x33L
FG 191/S24-12	12-Adptador M16*1.5xM14x33L
FG 191/S24-13	13-Adptador M18*1.5xM14 x33L
FG 191/S24-14	14-Adptador M31*0.75xM14x62L
FG 191/S24-15	15-Adptador M26*0.75xM14x62L
FG 191/S24-16	16-Adptador M27*1.0xM14x45L
FG 191/S24-17	17-Adptador M27*0.75xM14x45L
FG 191/S24-18	18-Adptador M25*1.0xM14x45L
FG 191/S24-19	19-Adptador M25*0.5xM14x45L
FG 191/S24-20	20-Adptador M29*1.0xM14x45L
FG 191/S24-3	3-Adptador M20*1.0xM14 x66L



**FG 191/S14**

~~150,00€~~

**89,00€**

**KIT DE LIMPEZA DO ASSENTO DO INJETOR**

No caso do ABS



CÓDIGO	DESCRIÇÃO
FG 191/S14-2	1- Haste roscada M5X0.8XL200mm
FG 191/S14-3	2- Tampa de fecho do assento do injetor
FG 191/S14-4	3- Escova longa para limpeza da sede do injetor
FG 191/S14-1	4- Extensão flexível
FG 191/S14-6	5- Escova para copos Ø 15
FG 191/S14-7	6- Escova para copos Ø 20
FG 191/S14-8	7- Escova Ø 24x85L
FG 191/S14-9	8- Escova Ø 18x85L
FG 191/S14-10	9- Escova Ø 21x85L

**FG 190/S6B**

~~165,00€~~

**99,00€**

**JOGO PARA LIMPEZA LOCAIS INJETORES**

No caso do ABS



**FG 175/FT2**

~~82,50€~~

**49,90€**

**CHAVE PARA BÓIAS DO RESERVATÓRIO DE COMBUSTÍVEL**

Para molduras de plástico Citroën e Peugeot  
L/mm 157



**FG 175/FT4**

~~72,50€~~

**42,90€**

**CHAVE PARA BÓIAS DO RESERVATÓRIO DE COMBUSTÍVEL**

Para virolas de plástico Grupo VAG  
L/mm 180



**FG 175/FT1**

~~67,00€~~

**39,90€**

**CHAVE PARA BÓIAS DO RESERVATÓRIO DE COMBUSTÍVEL**

Para virolas de alumínio Fiat, VW, Opel, Mercedes, BMW  
L/mm 170

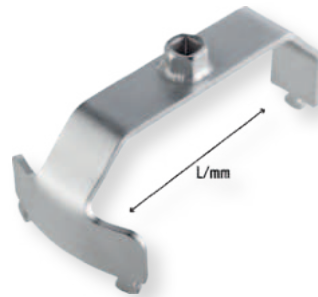

**FG 175/FT3**

~~85,00€~~

**51,90€**

**CHAVE PARA BÓIAS DO RESERVATÓRIO DE COMBUSTÍVEL**

Para lunetas de plástico FCA (Fiat Freemont, 500L, 500X, Jeep Renegade, etc.)  
L/mm 145

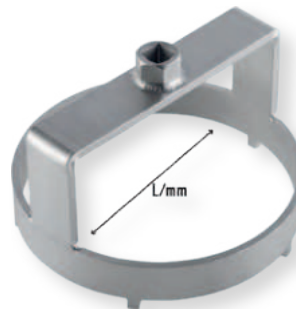

**FG 175/FT5**

~~72,50€~~

**42,90€**

**CHAVE PARA BÓIAS DO RESERVATÓRIO DE COMBUSTÍVEL**

Para molduras de alumínio Grupo OPEL





FG 174/F2

~~72,50€~~

43,50€

CHAVE PARA BÓIAS DO RESERVATÓRIO DE COMBUSTÍVEL GRUPO FCA  
L/MM 130

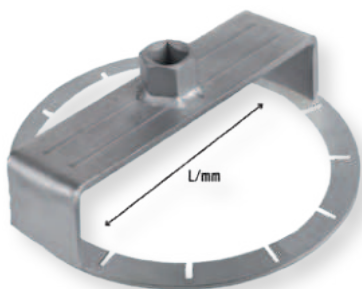

FG 174/SC

~~118,50€~~

74,90€

CHAVE REGULÁVEL PARA BÓIAS DO RESERVATÓRIO DE COMBUSTÍVEL  
Ømm: 88-170



FG 182/S16

~~530,00€~~

319,00€

JOGO FERRAMENTAS REMOÇÃO VELAS DE INCANDESCÊNCIA

No caso do ABS



Brocas de titânio



Cone/Extrator de centragem em aço

FG 183/S5

~~113,50€~~

69,00€

JOGO 5 CHAVES PARA VELAS INCANDESCÊNCIA DE MOTOR DIESEL  
Conteúdo: 8,9,10,12,14mm



FG 189/S13

~~250,00€~~

159,00€

TESTER ESPECIAL PARA CONTROLE DO SISTEMA TURBO

Utilizado para verificar a estanquicidade do sistema de combustível desde o coletor de admissão até ao rolo do compressor



FG 179/S16

~~160,00€~~

89,00€

JOGO CHAVES PARA POLIAS DE ALTERNADOR





FG 178/SF

~~1.820,00€~~

899,00€

**EXTRACTOR LÍQUIDO DOS TRAVÕES**

Fonte de alimentação de 12V com cabos de bateria  
Equipado com compartimento de arrumação traseiro e recipiente de recuperação de óleo  
Equipado com sensor de fim de líquido  
Pressão regulável até 2 bar  
Caixa em aço inoxidável



42 mm



44, 45, 46mm

2 tampas na caixa

FG 180/S12

~~85,00€~~

51,90€

**JOGO PARA EMBRAIAGENS**

Cones de centragem Ø 12-20mm



FG 180/S17

~~350,00€~~

199,00€

**KIT PARA AJUSTE DA EMBREAGEM DUPLA (DMF)**

FG 178SF/AD13

~~60,00€~~

35,90€

**TAPPI OPTIONAL SPECIFICI PER MOTORI FORD**

Fiesta 2011-2016

FG 178SF/AD14

~~60,00€~~

35,90€

**TAPPI OPTIONAL SPECIFICI PER MOTORI FORD**

Mondeo dal 2014 - Fiesta dal 2016 - Mazda CX3/CX5 2011-2016

FG 178SF/AD13  
(Fiesta 2011-2016)FG 178SF/AD14  
(Mondeo dal 2014, Fiesta dal 2016  
Mazda CX3/CX5)

FG 180/S38

~~700,00€~~

419,00€

**JOGO PARA EMBRAIAGENS SAC**

FG 178/S6

~~330,00€~~

189,00€

**JOGO DE FICHAS PARA VEÍCULOS ASIÁTICOS**

Toyota, Hyundai, Nissan, Mitsubishi, Mazda, Subaru, Honda, Suzuki





**FG 178/BF**

~~255,00€~~

**149,00€**

**EXTRACTOR DE LÍQUIDO DE TRAVÕES**

Equipado com sondas e ligações universais



**FG 199/PF**

~~230,00€~~

**139,00€**

**KIT PNEUMÁTICO PARA OS ÊBOLOS DOS DISCOS DOS TRAVÕES**

Para destros e canhotos



**FG 628/S7**

~~115,00€~~

**69,00€**

**JOGO 3 CHAVES PARA JANTES DE LIGA LEVE COM ADAPTADORES PARA PARAFUSOS DANIFICADOS**

17, 19, 21mm

1/2"



**FG 199/SF**

~~60,00€~~

**37,90€**

**SERINGA DE EXTRAÇÃO DE ÓLEO DO CIRCUITO DE FREIO**

Equipado com ligações específicas para os acessórios do circuito de travagem

Junta interna de VITON

Capacità 200cc



**FG 125/LV**

~~20,00€~~

**11,90€**

**GANCHO DE ALAVANCA UNIVERSAL PARA EIXOS**

Para montagem e desmontagem simples e segura de peças de veio.

Graças ao seu design especial pode ser colocado muito próximo da suspensão.

**FG 198/S11**

~~138,00€~~

**82,90€**

**KIT DE DESMONTAGEM PARAFUSOS PINÇA DE FREIO**

BMW, Ford, VAG, Mercedes



**NEW**





FG 168/GA

~~60,00€~~

37,90€

**FERRAMENTA UNIVERSAL DE ESPALHAMENTO**

Elevada capacidade  
Utilização universal  
Superfícies de pressão paralelas  
Capacidade 5 - 11,5 mm



FG 165/S26

~~720,00€~~

459,00€

**JOGO DE FERRAMENTAS PARA EXTRACÇÃO E COLOCAÇÃO DE SILENT BLOCK**

Bujes para Ø 44-82mm  
4 varillas roscadas M10, M12, M14, M16



FG 166/S7

~~520,00€~~

329,00€

**JOGO EXTRACTORES ANÉIS DE ROLAMENTOS**

Pinças: Ø 40-45mm, 45-51mm, 50-55mm, 55-61mm  
Chaves de porcas: Ø 82,7mm, 58,9mm



FG 168/S7

~~265,00€~~

169,00€

**EXTRATOR EM FORMA DE C PARA CASQUILHOS E ROLAMENTOS**

Construção robusta com estrutura em aço  
Com adaptadores para ligações de 1/4", 3/8", 1/2", 3/4" para utilização em automóveis, carrinhas e veículos comerciais  
Parafuso mm 165 - H/mm 89

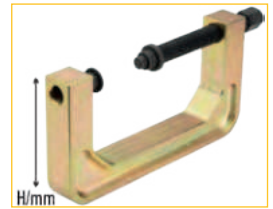

FG 159/PM

~~230,00€~~

139,00€

**COMPRESSORES DE AMORTECEDORES**

Equipado com 2 pares de hastes roscadas



FG 166/S28

~~475,00€~~

299,00€

**FERRAMENTAS PARA EXTRACÇÃO E COLOCAÇÃO OLAMENTOS DE RODAS**

Desmontagem Ø 34-45mm  
Montagem Ø 60-84mm

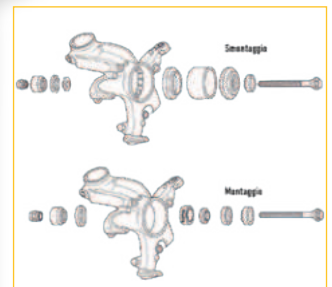



FG 98/A1

~~66,00€~~

41,90€

**CARREGADOR DE BATERIAS E MANTENEDOR DE CARGA 6/12V**

Pode ser utilizado com todos os tipos de baterias, tanto de chumbo-ácido como de lítio  
Indicador do nível de carga  
Proteção contra sobreaquecimento, inversão de polaridade, curto-circuito  
Fornecido com cabo com alicate e cabo com ilhós  
Tamanho 71x116 - Peso 170gr



FG 98/A6

~~120,00€~~

75,00€

**CARREGADOR DE BATERIAS E MANTENEDOR DE CARGA 6/12V**

Pode ser utilizado com todos os tipos de baterias, tanto de chumbo-ácido como de lítio  
Ecrã LCD  
Função WINTER (ciclo de carga otimizado a baixas temperaturas)  
Indicador do nível de carga  
Identificação das pilhas gastas  
Proteção contra sobreaquecimento, inversão de polaridade, curto-circuito  
Fornecido com cabo com alicate e cabo com ilhós  
Tamanho 200x76 mm - Peso 460gr



FG 98/A15

~~280,00€~~

179,00€

**CARREGADOR DE BATERIAS E MANTENEDOR DE CARGA 6/12/24V**

Pode ser utilizado com todos os tipos de baterias, tanto de chumbo-ácido como de lítio  
Ecrã LCD  
8 níveis de carga  
Função WINTER (ciclo de carga otimizado a baixas temperaturas)  
Função JUMP (carregamento para baterias muito fracas)  
Indicador do nível de carga  
Identificação das pilhas gastas  
Função de recuperação de bateria fraca para baterias de chumbo-ácido  
Proteção contra sobreaquecimento, inversão de polaridade, curto-circuito  
Cabo com pinças incluído  
Tamanho 200x120 mm - Peso 1300gr



FG 97/LT

~~250,00€~~

149,00€

**ARRANCADOR PORTÁTIL MULTI-FUNÇÕES**

Adequado para o arranque de emergência de motores com bateria de 12V  
Ecrã LCD  
2 saídas USB 5V 2.4A  
Cabo 12V 10A para tomada de isqueiro incluído  
Led com 5 modos  
3 modos de carregamento (incluído: carregador, cabo USB tipo C, adaptador 14V 1A para tomada de isqueiro)  
Função Power Bank  
Função Travel Lock  
Fornecido com o boost com pinças de arranque do motor, caixa



FG 220/BT

~~420,00€~~

249,00€

**TESTER DIGITAL PARA BATERIAS 12V E 24V**

Tensão de funcionamento: 9V a 35V DC  
Tempo de verificação da bateria: aprox. 1 minuto  
Pilha interna para a memória data/hora: CR1220 (1 unidade)  
Medidas mm 90x50x235



CARACTERÍSTICAS:	DISPLAY ILUMINADO
	SOFTWARE 6 LINGUAS: italiano; ingles; espanhol; polaco; alemão; francês
	IMPRESSORA INTEGRADA COM ROLO DE PAPEL TÉRMICO
	SISTEMA DE DETECÇÃO FALSA CONTACTO COM PINÇA
APLICAÇÃO:	TESTE DE BATERIA 12 E 24V
	TEST E DE ALTERADOR (INTELIGENTE E NORMAL) 12-24V CARGA
	TESTE DE SISTEMA DE ARRANQUE
SUPORTA BATERIAS DE:	PB, WET, GEL AGM, AGM FLAT, EFB
NORMAS:	CCA: 100-1700; IEC: 100-1000; EN: 100-1700; DIN: 100-1000; JIS
COMPRIMENTO DO CABO:	570 mm



FG 172/FA2

~~85,00€~~

53,90€

**ALICATE DE CATRACA PARA GRAMPOS DE MANGA**Função de aperto com roquete  
Abertura com mecanismo de mola

FG 172/AS2

~~113,00€~~

69,90€

**ALICATE COM EXTENSÃO PARA ABRAÇADEIRAS  
COM EXTENSÃO INTERCAMBIÁVEL**

Abertura mm 3-52



FG 172/FA

~~72,50€~~

39,90€

**ALICATE UNIVERSAL PARA ABRAÇADEIRAS**

FG 172/TC

~~35,00€~~

19,90€

**ALICATES PARA REMOVER PINOS DE CORRENTE**

FG 172/PA

~~70,00€~~

42,90€

**ALICATE PARA ABRAÇADEIRAS EM AÇO INOX**Também adequado para braçadeiras de cabos Panduit  
Ømm 4.7 - 9.5

FG 172/TG

~~49,50€~~

23,90€

**ALICATE PARA TUBOS DE ÁGUA E COMBUSTÍVEL**

FG 172/MA

~~98,00€~~

59,90€

**ALICATE DE PRESSÃO**

Com mordentes ajustáveis multi-grip

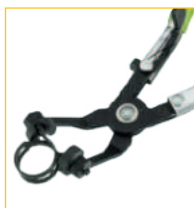

FG 181/PM2

~~93,00€~~

49,00€

**EXTRACTOR UNIVERSAL DE POLIAS**



FG 171/B

~~47,00€~~

28,90€

ALICATE DE LIGAÇÕES RÁPIDAS COMBUSTÍVEL



FG 172/G02

~~110,00€~~

62,90€

ALICATE PARA ABRAÇADEIRA OETIKER



3/8"



FG 198/PE

~~60,00€~~

37,90€

ALICATE DE REMOÇÃO DE PESOS DE EQUILÍBRIO DAS RODAS



FG 172/OT

~~56,00€~~

33,90€

ALICATE PARA ABRAÇADEIRA OETIKER



FG 184/S5

~~162,00€~~

99,00€

JOGO DE 5 CHAVES DE PORCA DO TENSOR DA CORREIA  
13,15,16,17,19mm



FG 172/S4

~~50,00€~~

19,90€

ADAPTADORES PARA REMOÇÃO DE UNIÕES DE FILTROS DIESEL



FG 171/FL

~~51,50€~~

29,90€

ALICATE GIRATÓRIO DE ENGATE RÁPIDO PARA TUBOS DE COMBUSTÍVEL,  
COM MANDÍBULAS ARTICULADAS



FG 172/CA

~~58,00€~~

34,90€

ALICATE PARA CACHIMBO DE VELA

Ømm: 14  
L/mm: 290





FG 215/S40

1.550,00€

899,00€



TESTER DIGITAL PARA COMPRESSÃO DO MOTOR COM INJETORES E VELAS DE INCANDESCÊNCIA FALSAS PARA SISTEMAS DIESEL

MADE IN ITALY



ACESSÓRIOS INCLUÍDOS:



TEST ALTERNADOR



TEST COMPRESSÃO

MADE IN ITALY



FG 219/S

3.350,00€

1999,00€



TESTER DIGITAL PARA COMPRESSÃO DO MOTOR, PRESSÃO DE COMBUSTÍVEL E PRESSÃO DO ÓLEO DO MOTOR

CARACTERÍSTICAS TÉCNICAS:

- PRECISÃO: 1%FS
- SOFTWARE EM 8 LÍNGUAS (IT, EN, DE, FR, ES, PT, GR, PL)
- ECRÃ LCD TOUCH SCREEN, 4.3"
- SENSOR 0-80 BAR E 0-2.500 BAR



TEST ALTERNADOR  
TEST COMPRESSÃO DO MOTOR  
TEST TENSÃO DE BATERIA



TEST COMPRESSÃO



TEST PRESSÃO COMBUSTÍVEL



TEST PRESSÃO ÓLEO DO MOTOR



FG 193DSG/S9

~~1.050,00€~~

629,00€

KIT PARA MONTAJE, DESMONTAJE Y REGISTRO EMBRAGUES DSG 7 VELOCIDADES

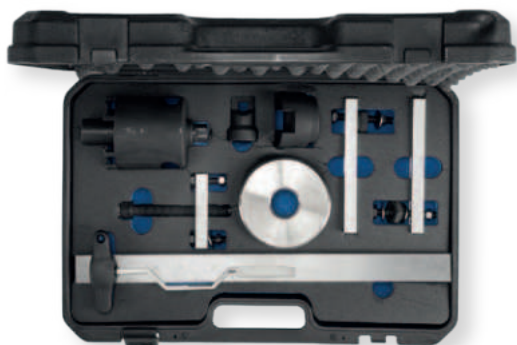

FG 193/S4

~~500,00€~~

299,00€

KIT EXTRATOR DE ROLAMENTOS DA CAIXA MANUAL VAG



FG 193/DCT

~~160,00€~~

99,00€

FERRAMENTA PARA GRUPO EMBRAIAGEM DCT

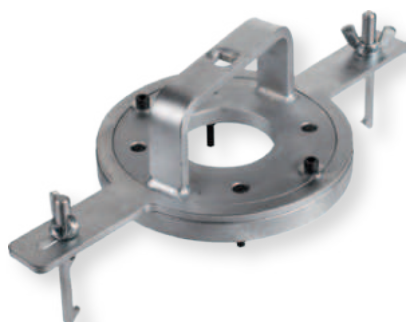

FG 194/TS

~~35,00€~~

21,90€

FERRAMENTA PARA CAIXA AUTOMÁTICA DSG COM DUPLA EMBRAIAGEM



FG 193/ATJ

~~45,00€~~

26,90€

FERRAMENTA PARA DESMONTAGEM TAMPA DE ÓLEO DA CAIXA AUTOMÁTICA



HASTES DE NÍVEL DE ÓLEO PARA CAIXAS AUTOMÁTICAS

Aplicações: Mercedes 722.6



FG 193/MB

~~65,00€~~

39,00€

FERRAMENTA DE MEDIÇÃO E DRENO ÓLEO DA CAIXA AUTOMÁTICA



CÓDIGO	€/LISTA	€/PROMO
FG 193/DS1	35,00€	19,90€
FG 193/DS2	35,00€	19,90€



## SETOR DA CARROCERIA

### Ferramentas de alto desempenho caracterizadas por detalhes dedicados à eficiência.

A nossa vasta e completa gama de ferramentas de carroçaria é dedicada ao trabalho de precisão e inclui kits de punção, jogos de raspadores, alavancas, facas, guias de arame, punhos, cunhas, saca-pinos, alicates, alavancas, alavancas de mola, ventosas, ferramentas dedicadas à remoção de farpas, ventosas e todas as ferramentas essenciais para os profissionais do setor.

Descubra todos na seção  
**AUTOMOTIVE**

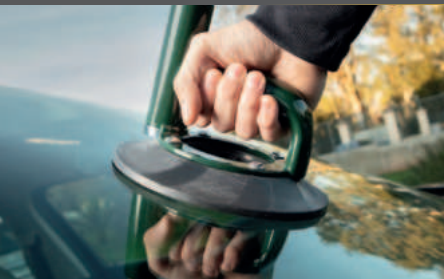

**VENTOSA EQUIPADO DE ADERÊNCIA E SISTEMA BOMBEANDO**



**FERRAMENTA DE REMOÇÃO PARA JUNTAS DE VIDRO**



**FERRAMENTA DE REMOÇÃO DE LASCAS**



**KIT 4 MINI VENTOSAS PARA JANELAS DE CARRO**



**RASPADOR MANUAL COM LÂMINA RETA**



**KIT DE 6 VENTOSAS SIMPLES**



FG 130AL/S5

~~37,50€~~

22,90€

**JOGO DE PUNÇÕES DE PLÁSTICO E PUNÇÃO DE ALUMÍNIO**

1 broca de alumínio ajustável 70mm-100mm  
Rosca M8x1,25  
4 punções de borracha dura, resistente a impactos e a riscos



FG 184/R2

~~23,00€~~

13,90€

**RASPADOR DE AÇO COM PROTEÇÃO EM PVC E CABO EM ABS**

L1/mm 275  
L2/mm: 25,6

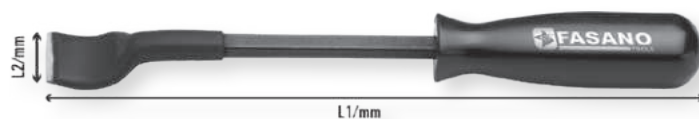

FG 184P/S3

~~26,00€~~

15,90€

**JOGO DE 3 RASPADORES DE PLÁSTICO**

Material: polipropileno de alta resistência



FG 186/S11

~~118,50€~~

69,00€

**JOGO 11 FERRAMENTAS EM NYLON PARA CARROÇARIAS**



FG 184/R1

~~21,00€~~

12,90€

**RASPADOR DE AÇO COM CABO DE ABS**

L1/mm 280  
L2/mm: 19



FG 188P/S2

~~41,50€~~

24,90€

**KIT DE CUNHA PARA REMOÇÃO DE MOLDURAS DE PLÁSTICO**

Material: polipropileno de alta resistência  
1 unidade com pega resistente à percussão  
1 unidade sem pega, ideal para espaços reduzidos



FG 184R/S3

~~46,50€~~

27,90€

**JOGO DE 3 RASPADORES DE AÇO COM CABO DE ABS**

L1/mm 280  
L2/mm: 10,8 - 25 - 40

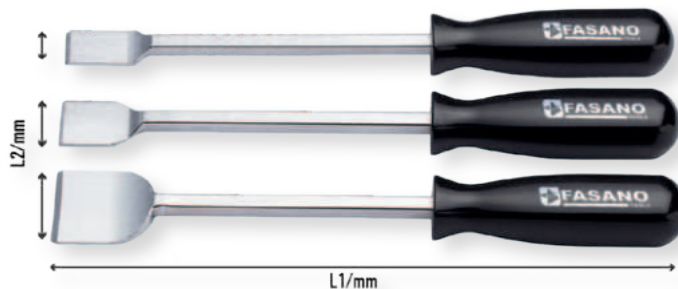



FG 188/P1

~~19,50€~~

11,90€

**ALAVANCA PARA PEÇAS PLÁSTICAS**

Material: Nylon e fibra de vidro  
Elevada resistência à torção  
Equipado com orifício para pendurar



FG 185P/S4

~~27,50€~~

16,90€

**KIT DE 4 ALAVANCAS PARA PEÇAS PLÁSTICAS**

Material: Nylon e fibra de vidro  
Elevada resistência à torção  
Equipado com orifício para pendurar

**KIT DE 3 ALAVANCAS DE PLÁSTICO**

CÓDIGO	€/LISTA	€/PROMO
FG 186/S3	12,00€	6,90€
FG 186/S3B	12,00€	6,90€

FG 186P/S5

~~37,50€~~

19,90€

**JOGO 5 EXTRACTORES DE CAVILHAS DE NYLON**

FG 185/S5

~~98,00€~~

59,00€

**JUEGO DE 5 EXTRACTORES DE CAVILHAS COM CABO DE ABS**

Conteúdo: FG 185/A1, FG 185/A2, FG 185/A6,  
FG 185/A7, FG 185/A8



FG 186/AL1

~~25,00€~~

14,90€

**ALAVANCA METÁLICA EXTRA PLANA**

Design único da lâmina com um lado curvo e outro reto para remover fixadores internos e externos mesmo nos espaços mais apertados  
Ponta fina e de alta resistência



FG 186/S5

~~98,00€~~

58,90€

**JOGO DE 5 EXTRACTOR DE CAVILHAS, LÂMINA DE AÇO INOXIDÁVEL**

FG 185B/S2

~~41,50€~~

24,90€

**JUEGO DE 2 EXTRACTORES DE CAVILHAS COM CABO DE ABS**



**FG 186/S4**

~~26,00€~~

**15,90€**

**JOGO DE 4 GANCHOS COM LÂMINA DE AÇO**

Com pega bimatéria



**FG 185/RM**

~~31,00€~~

**18,90€**

**FERRAMENTA DE REMOÇÃO DE PEGA DE APOIO DE MÃO - GRUPO VAG**

Pega em ABS  
L/mm 255



**FG 185/CR**

~~10,50€~~

**5,90€**

**FERRAMENTA DE REMOÇÃO DE MOLA**

Ideal para retirar as molas C das manivelas das janelas



**FG 185/OM**

~~30,00€~~

**18,90€**

**FERRAMENTA DE REMOÇÃO DO CLIP OMEGA**

Para Grupo VAG, Tesla, Mercedes-Benz (2008 ~ 2020)

Utilizável também para remover cliques semelhantes ao revestimento da bagagem Tesla (Modelo Y) e ao revestimento da porta Tesla (Modelo Y)



**NEW**

**FG 189/P01**

~~21,00€~~

**12,90€**

**FERRAMENTA DE REMOÇÃO DO CILINDRO DE TRAVAMENTO DA PORTA - GRUPO VAG**



**FG 189/P02**

~~40,00€~~

**23,90€**

**FERRAMENTA DE REMOÇÃO DO CILINDRO DE FECHO DAS PORTAS - VAG GROUP**



**FERRAMENTA DE REMOÇÃO DE FARPAS**

Ideal para a limpeza do canal da janela

Ponta esférica para evitar danificar as calhas das portas



**FG 183/RV1**

~~21,00€~~

**12,90€**

**FERRAMENTA DE REMOÇÃO DE VEDAÇÃO DE VIDRO**

Pega em ABS  
L/mm 255



CÓDIGO	L/MM	€/LISTA	€/PROMO
FG 182/RG10	255	19,50€	11,90€
FG 182/RG24	320	26,00€	15,90€



FG 183/CM

~~51,50€~~

29,90€

**FACA MANUAL EQUIPADA COM CABO E SISTEMA DE PARADA DE CABO**

Cabo e pega revestidos a PVC  
Fornecida com lâmina de 25 mm já montada



FG 183/RA1

~~26,00€~~

15,90€

**RASPADOR MANUAL DE LÂMINA RETA**

Fornecido com um cabo ABS de uma lâmina com orifício para pendurar  
Equipado com proteção da lâmina em ABS



**FACA DE CORTE**

Fornecido com cabo revestido a PVC de uma lâmina  
Sistema de bloqueio da lâmina com parafuso



FG 187/GR

~~29,50€~~

17,90€

**FERRAMENTA UNIVERSAL PARA FIXAÇÃO DE JUNTAS**

Equipado com 6 acessórios  
Sistema de guia de rolos  
Pega em ABS



CÓDIGO	L/MM	€/LISTA	€/PROMO
FG 183/CK250	250	22,00€	12,90€
FG 183/CK450	450	33,00€	19,90€
FG 183/CK600	600	41,50€	25,90€

FG 187/GU

~~29,50€~~

17,90€

**ALAVANCA PARA VIDROS**

L1/mm: 345 - L2/mm: 145



FG 187/GU2

~~27,50€~~

16,90€

**GUIA DE OS COM CABO EM T EM ABS**

L/mm: 320



FG 187/S7

~~220,00€~~

139,00€

**FERRAMENTAS PARA VIDROS DE VIATURAS**



FG 187/K25

~~46,00€~~

28,90€

**VENTOSA SIMPLES**

L/mm: 117  
Capacidade kg: 25





FG 187/S2

~~720,00€~~

439,00€

CONJUNTO DE REMOÇÃO DO PARA-BRISAS COM SISTEMA DE VENTOSA DE ROQUETE

Com caixa de ABS



FG 188P/S4

~~68,00€~~

42,90€

CONJUNTO DE PROTEÇÃO DO PAINEL DE INSTRUMENTOS COM PEGA



FG 187/K40

~~196,00€~~

119,00€

VENTOSA SIMPLE COM ALÇA E SISTEMA DE BOMBEAMENTO

Capacidade 40Kg

Diâmetro: 178mm - 7"



FG 165/BC1

~~45,50€~~

28,90€

EXTRACTOR BRAÇO LIMPA PÁRA-BRISAS

Ø/mm: 30-50

L/mm: 42



FG 187/K30

~~72,50€~~

43,90€

VENTOSA DUPLA

L1/mm: 117

L2/mm: 380

Capacidade kg: 30



FG 165/BC3

~~68,00€~~

42,90€

EXTRACTOR AJUSTÁVEL PARA BRAÇOS DO LIMPA PARA-BRISAS BMW

Max Ø/mm: 37,5

L/mm: 64

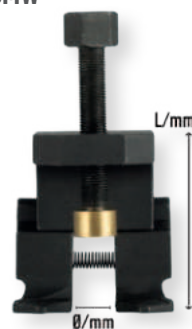

FG 187/PN

~~265,00€~~

169,00€

JOGO DE REPARAÇÃO MOSSAS, COM 3 VENTOSAS



FG 165BC/S6

~~230,00€~~

139,00€

JOGO DE 6 EXTRACTORES PARA BRAÇOS DO LIMPA PARA-BRISAS

1: VW, Porsche; 2: Ford, Seat, Mercedes; 3: BMW, VW; 4: Audi

A3-A4-A5-A6; 5: VW, Opel, Honda; 6: Audi Q7





## PROFESSIONAL EQUIPMENT

### PREGUIÇAS PARA VEÍCULOS



CE

CÓDIGO	CAPACITÀ KG	H-MIN/MAX MM	€/LISTA	€/PROMO
FG 725/3T	3000	285-425	100,00€	55,90€
FG 725/6T	6000	390-605	170,00€	95,00€
FG 725/12T	12000	495-720	300,00€	169,00€

**FG 750/A**

~~430,00€~~

**249,00€**

### ELEVADOR PARA RODAS DE VEÍCULOS

Capacidade 680 kg  
L1/mm: 550 - L2/mm: 620  
Sistema de elevação a pedal  
Equipado com 4 rodas giratórias



CE

### MACACOS DE GARRAFA HIDRÁULICOS



CE

CÓDIGO	CAPACITÀ KG	H-MIN/MAX MM	€/LISTA	€/PROMO
FG 735/4T	4000	193-373	85,00€	49,00€
FG 735/6T	6000	210-416	98,00€	55,00€
FG 735/10T	10000	230-460	142,00€	79,00€
FG 735/16T	16000	230-440	168,00€	89,00€
FG 735/20T	20000	242-452	210,00€	109,00€

**FG 748/0.5T**

~~250,00€~~

**139,00€**

### SUPORTE PARA MOTORES

Capacidade kg: 500Kg  
L/mm: 1550

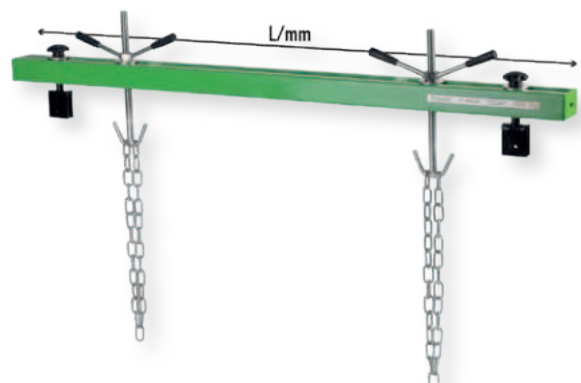



**CONFIÁVEL**

**RÁPIDO**

**SEGURO**



**FG 750**  
**PRENSA**  
**PNEUMÁTICA**  
**DE MOLA**  
**DOS AMORTECEDORES**

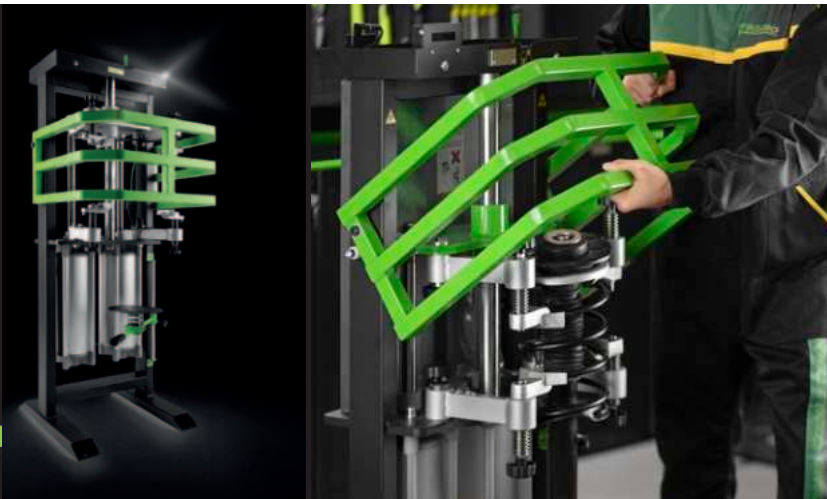

**MADE IN ITALY**

**FG 750/1P**

~~2.850,00€~~

**1.599,00€**

**PRENSA PNEUMÁTICA PARA MOLAS DE AMORTECEDORES**

Potência de impulso: 1,2 toneladas (10 bar) - 0,9 toneladas (8 bar)  
Curso de compressão da mola: 300 mm



**FG 750/2P**

~~3.400,00€~~

**1.899,00€**

**PRENSA PNEUMÁTICA PARA MOLAS DE AMORTECEDORES**

Potência de impulso: 2,4 toneladas (10 bar) - 1,9 toneladas (8 bar)  
Curso de compressão da mola: 300 mm



**FG 752/1P**

~~3.500,00€~~

**1.999,00€**

**PRENSA PNEUMÁTICA PARA MOLAS DE AMORTECEDORES COM DISPLAY DIGITAL**

O visor digital mostra a pressão aplicada durante a utilização



**FG 752/2P**

~~4.200,00€~~

**2.199,00€**

**PRENSA PNEUMÁTICA PARA MOLAS DE AMORTECEDORES COM DISPLAY DIGITAL**

O visor digital mostra a pressão aplicada durante a utilização



**FG 213/LT**~~330,00€~~**189,00€****ALAVANCA PARA PUXAR O BRAÇO E AMORTECEDORES****FG 740/0.5T**~~600,00€~~**319,00€****MACACO DE FOSSAS HIDRÁULICO**

Sistema de elevação a pedal  
Equipado com 4 rodas giratórias  
Portata 500 kg



CE

**FG 213/SM**~~790,00€~~**449,00€****SUPORTE PARA MOTORES INFERIOR**

Útil para apoiar o motor ou a caixa de velocidades durante os trabalhos de manutenção, tanto em veículos de passageiros como em veículos comerciais

**FG 738/1T**~~1.100,00€~~**599,00€****GRUA HIDRÁULICA REBATÍVEL**

Versão dobrável  
Rodas de aço para maior durabilidade e capacidade  
Portata 1.000 kg  
L2/mm: 800 - A/mm: 80

CE

**FG 745/CMR**~~950,00€~~**529,00€****SUPORTE PARA MOTORES DOBRÁVEL**

Versão dobrável  
Possibilidade de rotação de 360  
Rodas de aço para maior durabilidade e capacidade  
L1/mm: 995 - L2/mm 585



Sistema de rotação 360°  
com manivela



**FG 745/CMF**

~~470,00€~~

**269,00€**

**SUPOORTE PARA MOTORES**

Possibilidade de rotação de 360°  
Rodas de aço para maior durabilidade e capacidade  
L1/mm: 860 - L2/mm 725



Sistema de rotação de 360°

**FG 710/D**

~~245,00€~~

**129,00€**

**ASSENTO COM RODAS, EQUIPADO COM ACESSÓRIOS**

Gaveta grande montada em corrediças telescópicas  
Equipada com acessórios para peças pequenas e suportes para latas facilmente amovíveis



**FG 710/C**

~~150,00€~~

**85,00€**

**ASSENTO COM RODAS, EQUIPADO COM ACESSÓRIOS**

2 gavetas com corrediças telescópicas  
Acessório porta-latas em plástico à prova de choque  
Assento estofado e revestido a PVC



**FG 710/E**

~~150,00€~~

**85,00€**

**ESTERIA DE PLÁSTICO À PROVA DE CHOQUE**

6 rodízios giratórios

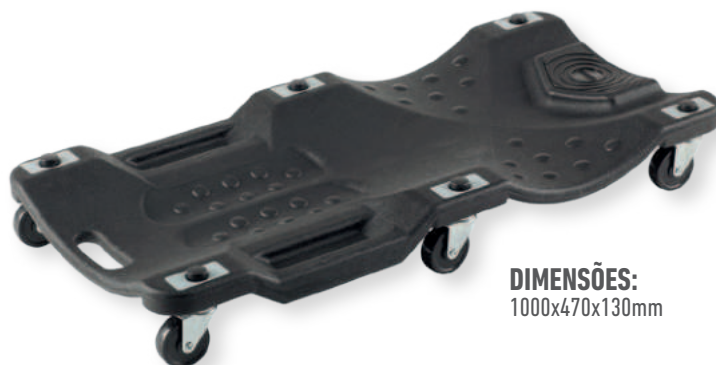

**DIMENSÕES:**  
1000x470x130mm



FG 718/2.5T

470,00€

269,00€

### MACACO HIDRÁULICO 2.5T MODELO CURTO

- Construção robusta em aço
- Velocidade de descida controlada
- Pega com borracha à prova de choque
- 4 rodas de nylon
- Válvula de purga de ar



FG 718/3.5T

562,00€

299,00€

### MACACO HIDRÁULICO 3.5T MODELO CURTO E ABAIXADO

- Design baixo, ideal para trabalhar em veículos com pouca distância ao solo
- Elevada capacidade de carga para utilização também em veículos todo-o-terreno e carrinhas
- Construção robusta em aço
- Velocidade de descida controlada
- Pega com borracha à prova de choque
- 4 rodas de nylon
- Válvula de purga de ar





FG 719/2T

~~740,00€~~

399,00€

**MACACO HIDRÁULICO 2T MODELO LONGO E ABAIXADO**

Design baixo, ideal para trabalhar em veículos com pouca distância ao solo  
 Versão longa  
 Elevação através de pega com borracha à prova de choque  
 Construção robusta em aço  
 Velocidade de descida controlada  
 4 rodas de nylon  
 Válvula de purga de ar

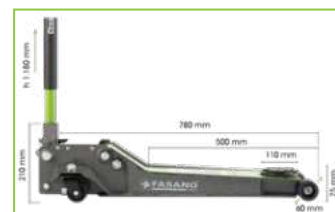

FG 721/2T

~~910,00€~~

479,00€

NEW

**MACACO HIDRÁULICO 2T - MODELO LONGO E ABAIXADO COM RODAS BASCULANTES DUPLAS**

É também ideal para trabalhar em veículos com pouca distância ao solo  
 Pega de elevação revestido a borracha anti choque  
 Construção robusta em aço  
 Velocidade de descida controlada  
 Equipado com válvula de libertação de ar  
 6 rodas de nylon



**MODELO REBAIXADO**  
 RODAS DIANTEIRAS INCLINÁVEIS

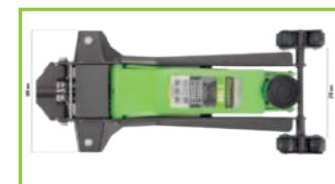

FG 722/5T

~~1.440,00€~~

799,00€

**MACACO HIDRÁULICO DE 5 TONELADAS - MODELO LONGO PARA VEÍCULOS PESADOS**

Sistema de elevação auxiliar com pedal  
 Rodas de aço montadas em rolamentos de esferas  
 Auto-retorno integrado



**SISTEMA DE ELEVAÇÃO AUXILIAR COM PEDAL**



**RODAS DE AÇO MONTADAS EM ROLAMENTOS DE ESFERAS**

CÓDIGO	PÁGINA	€/PROMO
FG BEST 108	10	139,00€
FG BEST 171	10	199,00€
FG 22/S6	14	21,90€
FG 22/S8B	14	31,90€
FG 22/S8	14	27,90€
FG 22/S12	14	49,90€
FG 22TX/S6	15	36,90€
FG 22RTX/S8	15	49,90€
FG 22FX/S10	15	89,90€
FG 22E/S6	18	34,90€
FG 22E/SZ6	18	34,90€
FG 39/S4	7	109,00€
FG 44/MT3	24	6,90€
FG 44/MT5	24	11,90€
FG 44/MT8	24	13,90€
FG 44/MT10	24	16,90€
FG 49/L	23	11,90€
FG 49/MU	23	17,90€
FG 49/TC	23	27,90€
FG 49/CF	23	17,90€
FG 49/HE200	23	13,90€
FG 49/HE250	23	16,90€
FG 49/HE300	23	21,90€
FG 49/HE350	23	24,90€
FG 49/TCX	23	34,90€
FG 51/S4	17	59,90€
FG 51/S4B	17	62,90€
FG 55/S4	17	79,90€
FG 55/S4B	17	82,90€
FG 58/C250	17	26,90€
FG 59XT/S3	17	49,90€
FG 59XT/S3B	17	59,90€
FG 59IS/S3	18	64,90€
FG 68U/S439	18	169,00€
FG 70/S110	22	199,00€
FG 75TIN/S25	22	139,00€
FG 75CO/S25	22	149,00€
FG 77/TT	23	5,90€
FG 77/PVC4	23	31,90€
FG 85/S31	16	39,90€
FG 85/175-S9	17	65,00€
FG 85/175-S10	17	69,00€
FG 88/25-S31	16	59,00€
FG 92/PM	25	11,90€
FG 92/PM4	25	13,90€
FG 92/GR	25	15,90€
FG 92/PF	25	14,90€
FG 93/M50	27	17,90€
FG 93/M95	27	17,90€
FG 94/MI	65	24,90€
FG 94/MS	65	18,90€
FG 94/R	65	11,90€
FG 94/T	65	9,90€
FG 95/CA	24	29,90€
FG 95/CA2	24	74,90€
FG 95/DG	24	56,90€
FG 96/DG	19	119,00€
FG 96/CA	24	32,90€
FG 96/CA2	24	69,00€
FG 96/SS36	26	39,90€
FG 96/SS30	26	29,90€
FG 96/SS60	26	36,00€
FG 97/DG	19	79,00€
FG 97/LT	133	149,00€
FG 98/DG	19	199,00€
FG 98/GAS	26	79,00€

CÓDIGO	PÁGINA	€/PROMO
FG 98/LT	26	119,00€
FG 98/A1	133	41,90€
FG 98/A6	133	75,00€
FG 98/A15	133	179,00€
FG 99/DG	19	149,00€
FG 100VD/7T	61	699,00€
FG 100VW/7T	61	699,00€
FG 100BW/7T	61	699,00€
FG 100BD/7T	61	699,00€
FG 100RD/7T	61	699,00€
FG 100RY/7T	61	699,00€
FG 100CW/7T	61	699,00€
FG 100MA/7T	61	699,00€
FG 100RW/7T	61	699,00€
FG 100RB/7T	61	699,00€
FG 100DP/7T	61	699,00€
FG 100DW/7T	61	699,00€
FG 100BY/7T	61	699,00€
FG 100GW/7T	61	699,00€
FG 100V/5T	61	519,00€
FG 100B/5T	61	519,00€
FG 100R/5T	61	519,00€
FG 100D/5T	61	519,00€
FG 100W/5T	61	519,00€
FG 100V/6T	61	539,00€
FG 100B/6T	61	539,00€
FG 100R/6T	61	539,00€
FG 100D/6T	61	539,00€
FG 100V/7T	61	559,00€
FG 100B/7T	61	559,00€
FG 100R/7T	61	559,00€
FG 100D/7T	61	559,00€
FG 100W/7T	61	559,00€
FG 100V/AS212	70	1.199,00€
FG 100B/AS212	70	1.199,00€
FG 100R/AS212	70	1.199,00€
FG 100D/AS212	70	1.199,00€
FG 100W/AS212	70	1.199,00€
FG 100V/AS183	71	1.199,00€
FG 100B/AS183	71	1.199,00€
FG 100R/AS183	71	1.199,00€
FG 100D/AS183	71	1.199,00€
FG 100W/AS183	71	1.199,00€
FG 100V/AS371	72	1.399,00€
FG 100B/AS371	72	1.399,00€
FG 100R/AS371	72	1.399,00€
FG 100D/AS371	72	1.399,00€
FG 100W/AS371	72	1.399,00€
FG 100V/AS224	79	1.199,00€
FG 100B/AS224	79	1.199,00€
FG 100R/AS224	79	1.199,00€
FG 100D/AS224	79	1.199,00€
FG 100W/AS224	79	1.199,00€
FG 100V/AS413	81	1.399,00€
FG 100B/AS413	81	1.399,00€
FG 100R/AS413	81	1.399,00€
FG 100D/AS413	81	1.399,00€
FG 100W/AS413	81	1.399,00€
FG 100V/AS230	82	1.399,00€
FG 100B/AS230	82	1.399,00€
FG 100R/AS230	82	1.399,00€
FG 100D/AS230	82	1.399,00€
FG 100W/AS230	82	1.399,00€
FG 100V/AS382	84	1.499,00€
FG 100B/AS382	84	1.499,00€

CÓDIGO	PÁGINA	€/PROMO
FG 100R/AS382	84	1.499,00€
FG 100D/AS382	84	1.499,00€
FG 100W/AS382	84	1.499,00€
FG 100VD/AS355	85	1.599,00€
FG 100VW/AS355	85	1.599,00€
FG 100BW/AS355	85	1.599,00€
FG 100RD/AS355	85	1.599,00€
FG 100RY/AS355	85	1.599,00€
FG 100CW/AS355	85	1.599,00€
FG 100MA/AS355	85	1.599,00€
FG 100RW/AS355	85	1.599,00€
FG 100RB/AS355	85	1.599,00€
FG 100DP/AS355	85	1.599,00€
FG 100DW/AS355	85	1.599,00€
FG 100BY/AS355	85	1.599,00€
FG 100GW/AS355	85	1.599,00€
FG 100V/AS56	91	1.299,00€
FG 100B/AS56	91	1.299,00€
FG 100R/AS56	91	1.299,00€
FG 100D/AS56	91	1.299,00€
FG 100W/AS56	91	1.299,00€
FG 100/03G	92	89,90€
FG 100/03G-A	92	99,90€
FG 100/03L	92	89,90€
FG 100/03L-A	92	99,90€
FG 100/03H	92	179,00€
FG 100/03H-A	92	189,00€
FG 100/03E	92	59,90€
FG 100/03F	92	69,00€
FG 100/07C	92	65,90€
FG 100/07D	92	95,90€
FG 100/08C	92	159,00€
FG 100/10C	92	249,00€
FG 100/10D	93	349,00€
FG 100/17	93	79,90€
FG 100/17E	93	169,00€
FG 100/18	93	179,00€
FG 100/19	93	139,00€
FG 100/21B	93	149,00€
FG 100/21C	93	149,00€
FG 100/21M	93	99,00€
FG 100/21D	93	99,00€
FG 100/21H	93	269,00€
FG 100/21TX	93	159,00€
FG 100/81F	93	119,00€
FG 100/23C	94	129,00€
FG 100/23B	94	219,00€
FG 100/39XT	94	66,90€
FG 100/41C	94	66,90€
FG 100/42C	94	73,90€
FG 100/65B	94	54,90€
FG 100/65C	94	86,90€
FG 100/45D	94	39,90€
FG 100/45E	94	49,90€
FG 100/45F	94	41,90€
FG 100/45G	94	41,90€
FG 100/45I	95	49,90€
FG 100/45T	95	52,90€
FG 100/45H	95	49,00€
FG 100/48G	95	79,90€
FG 100/51H	95	89,00€
FG 100/50F	95	53,90€
FG 100/50G	95	53,90€
FG 100/56C	95	89,90€
FG 100/54	95	119,00€

CÓDIGO	PÁGINA	€/PROMO
FG 100/76C	95	169,00€
FG 100/03M	92	279,00€
FG 100/45R	96	149,00€
FG 100/39F	97	239,00€
FG 100/39E	97	269,00€
FG 100/21F	98	599,00€
FG 100/81G	98	499,00€
FG 100/56D	99	229,00€
FG 100/95B	99	399,00€
FG 100/95C	99	449,00€
FG 101D/5G	64	359,00€
FG 101D/6G	64	379,00€
FG 101D/7G	64	399,00€
FG 101V/3G	65	249,00€
FG 101D/AS165	66	699,00€
FG 101D/AS196	67	799,00€
FG 102V/5G	60	469,00€
FG 102B/5G	60	469,00€
FG 102R/5G	60	469,00€
FG 102D/5G	60	469,00€
FG 102V/6G	60	499,00€
FG 102B/6G	60	499,00€
FG 102R/6G	60	499,00€
FG 102D/6G	60	499,00€
FG 102V/7G	60	529,00€
FG 102B/7G	60	529,00€
FG 102R/7G	60	529,00€
FG 102D/7G	60	529,00€
FG 102V/8G	60	559,00€
FG 102B/8G	60	559,00€
FG 102R/8G	60	559,00€
FG 102D/8G	60	559,00€
FG 102V/AS205	68	999,00€
FG 102B/AS205	68	999,00€
FG 102R/AS205	68	999,00€
FG 102D/AS205	68	999,00€
FG 102/03G	74	85,00€
FG 102/03L	74	89,00€
FG 102/03H	74	149,00€
FG 102/03E	74	51,90€
FG 102/03F	74	63,90€
FG 102/07C	74	59,90€
FG 102/07D	74	82,90€
FG 102/08C	74	149,00€
FG 102/10C	74	209,00€
FG 102/13C	74	119,00€
FG 102/17	75	79,90€
FG 102/17E	75	159,00€
FG 102/19	75	119,00€
FG 102/19B	75	119,00€
FG 102/21B	75	139,00€
FG 102/21C	75	139,00€
FG 102/21E	75	99,00€
FG 102/21D	75	99,00€
FG 102/21TX	75	139,00€
FG 102/21H	75	129,00€
FG 102/21R	75	139,00€
FG 102/25	75	239,00€
FG 102/25B	75	239,00€
FG 102/23C	76	89,00€
FG 102/51H	76	79,90€
FG 102/39XT	76	59,90€
FG 102/39D	76	45,90€
FG 102/41C	76	57,90€
FG 102/42C	76	59,90€
FG 102/45D	76	27,90€



CÓDIGO	PÁGINA	€/PROMO
FG 102/45E	76	33,90€
FG 102/45F	76	32,90€
FG 102/45G	76	32,90€
FG 102/45U	76	59,90€
FG 102/45I	77	39,90€
FG 102/45L	77	40,90€
FG 102/45T	77	39,90€
FG 102/48G	77	72,90€
FG 102/50F	77	45,90€
FG 102/50G	77	45,90€
FG 102/56C	77	79,90€
FG 102/60D	77	36,90€
FG 102/62B	77	59,90€
FG 102/65B	77	41,90€
FG 102/VA1	77	8,90€
FG 102V/AS335	89	1.499,00€
FG 102D/AS335	89	1.499,00€
FG 102B/AS335	89	1.499,00€
FG 102R/AS335	89	1.499,00€
FG 104V/6G	60	579,00€
FG 104B/6G	60	579,00€
FG 104R/6G	60	579,00€
FG 104D/6G	60	579,00€
FG 104V/7G	60	599,00€
FG 104B/7G	60	599,00€
FG 104R/7G	60	599,00€
FG 104D/7G	60	599,00€
FG 104V/AS284	88	1.599,00€
FG 104D/AS284	88	1.599,00€
FG 104B/AS284	88	1.599,00€
FG 104R/AS284	88	1.599,00€
FG 105V/5G	62	689,00€
FG 105B/5G	62	689,00€
FG 105R/5G	62	689,00€
FG 105D/5G	62	689,00€
FG 105V/6G	62	739,00€
FG 105B/6G	62	739,00€
FG 105R/6G	62	739,00€
FG 105D/6G	62	739,00€
FG 105V/7G	62	769,00€
FG 105B/7G	62	769,00€
FG 105R/7G	62	769,00€
FG 105D/7G	62	769,00€
FG 106/B	103	189,00€
FG 106/C	103	229,00€
FG 107/A	103	89,00€
FG 108/B	65	89,00€
FG 109V/6G	62	849,00€
FG 109B/6G	62	849,00€
FG 109R/6G	62	849,00€
FG 109D/6G	62	849,00€
FG 109V/7G	62	879,00€
FG 109B/7G	62	879,00€
FG 109R/7G	62	879,00€
FG 109D/7G	62	879,00€
FG 111/AS104	30	329,00€
FG 111/A	30	32,90€
FG 111/B	30	39,90€
FG 111/C	30	49,90€
FG 113/A	30	119,00€
FG 113/B	30	129,00€
FG 113/C	30	149,00€
FG 113/D	30	189,00€
FG 117/CO24V	109	2.499,00€
FG 117/CO24D	109	2.499,00€
FG 117/CO24B	109	2.499,00€

CÓDIGO	PÁGINA	€/PROMO
FG 117/CO24R	109	2.499,00€
FG 117V/AS210	110	2.699,00€
FG 117D/AS210	110	2.699,00€
FG 117B/AS210	110	2.699,00€
FG 117R/AS210	110	2.699,00€
FG 117/CO2V	111	1.799,00€
FG 117/CO2D	111	1.799,00€
FG 117/CO2B	111	1.799,00€
FG 117/CO2R	111	1.799,00€
FG 117/CO3V	111	1.999,00€
FG 117/CO3D	111	1.999,00€
FG 117/CO3B	111	1.999,00€
FG 117/CO3R	111	1.999,00€
FG 117/CO16V	112	1.599,00€
FG 117/CO16D	112	1.599,00€
FG 117/CO16B	112	1.599,00€
FG 117/CO16R	112	1.599,00€
FG 117/CO30V	112	3.499,00€
FG 117/CO30D	112	3.499,00€
FG 117/CO30B	112	3.499,00€
FG 117/CO30R	112	3.499,00€
FG 118/CO30V	105	3.399,00€
FG 118/CO30D	105	3.399,00€
FG 118/CO30B	105	3.399,00€
FG 118/CO30R	105	3.399,00€
FG 118/CO2V	106	2.499,00€
FG 118/CO2D	106	2.499,00€
FG 118/CO2B	106	2.499,00€
FG 118/CO2R	106	2.499,00€
FG 118/CO3V	106	2.899,00€
FG 118/CO3D	106	2.899,00€
FG 118/CO3B	106	2.899,00€
FG 118/CO3R	106	2.899,00€
FG 118/CO22V	107	7.899,00€
FG 118/CO22D	107	7.899,00€
FG 118/CO22B	107	7.899,00€
FG 118/CO22R	107	7.899,00€
FG 119V/CO16	119	899,00€
FG 119B/CO16	119	899,00€
FG 119R/CO16	119	899,00€
FG 119V/CO12	119	1.199,00€
FG 119B/CO12	119	1.199,00€
FG 119R/CO12	119	1.199,00€
FG 119V/CO25	120	949,00€
FG 119B/CO25	120	949,00€
FG 119R/CO25	120	949,00€
FG 119V/CO22	120	1.199,00€
FG 119B/CO22	120	1.199,00€
FG 119R/CO22	120	1.199,00€
FG 119V/CO33	121	1.599,00€
FG 119B/CO33	121	1.599,00€
FG 119R/CO33	121	1.599,00€
FG 119V/CO36	121	1.599,00€
FG 119B/CO36	121	1.599,00€
FG 119R/CO36	121	1.599,00€
FG 119V/CO18	122	999,00€
FG 119B/CO18	122	999,00€
FG 119R/CO18	122	999,00€
FG 119V/CO27	122	1.099,00€
FG 119B/CO27	122	1.099,00€
FG 119R/CO27	122	1.099,00€
FG 119M/CO13	123	499,00€
FG 119M/CO28	123	599,00€
FG 119M/CO37	123	699,00€
FG 120/CO1V	114	1.189,00€
FG 120/CO1D	114	1.189,00€

CÓDIGO	PÁGINA	€/PROMO
FG 120/CO1B	114	1.189,00€
FG 120/CO1R	114	1.189,00€
FG 120/CO2V	114	1.249,00€
FG 120/CO2D	114	1.249,00€
FG 120/CO2B	114	1.249,00€
FG 120/CO2R	114	1.249,00€
FG 120/CO3V	115	1.289,00€
FG 120/CO3D	115	1.289,00€
FG 120/CO3B	115	1.289,00€
FG 120/CO3R	115	1.289,00€
FG 120/CO4V	115	1.399,00€
FG 120/CO4D	115	1.399,00€
FG 120/CO4B	115	1.399,00€
FG 120/CO4R	115	1.399,00€
FG 120V/AS217	116	1.699,00€
FG 120D/AS217	116	1.699,00€
FG 120B/AS217	116	1.699,00€
FG 120R/AS217	116	1.699,00€
FG 120V/AS224	117	1.799,00€
FG 120D/AS224	117	1.799,00€
FG 120B/AS224	117	1.799,00€
FG 120R/AS224	117	1.799,00€
FG 121/B125	27	179,00€
FG 121/B150	27	229,00€
FG 121/B200	27	339,00€
FG 122V/5G	59	499,00€
FG 122D/5G	59	499,00€
FG 122B/5G	59	499,00€
FG 122R/5G	59	499,00€
FG 122V/6G	59	529,00€
FG 122D/6G	59	529,00€
FG 122B/6G	59	529,00€
FG 122R/6G	59	529,00€
FG 122V/7G	59	569,00€
FG 122D/7G	59	569,00€
FG 122B/7G	59	569,00€
FG 122R/7G	59	569,00€
FG 122V/AS168	69	1.199,00€
FG 122D/AS168	69	1.199,00€
FG 122B/AS168	69	1.199,00€
FG 122R/AS168	69	1.199,00€
FG 122V/AS217	78	1.099,00€
FG 122D/AS217	78	1.099,00€
FG 122B/AS217	78	1.099,00€
FG 122R/AS217	78	1.099,00€
FG 122V/AS283	80	1.349,00€
FG 122D/AS283	80	1.349,00€
FG 122B/AS283	80	1.349,00€
FG 122R/AS283	80	1.349,00€
FG 122V/AS402	83	1.499,00€
FG 122D/AS402	83	1.499,00€
FG 122B/AS402	83	1.499,00€
FG 122R/AS402	83	1.499,00€
FG 124V/6G	59	639,00€
FG 124D/6G	59	639,00€
FG 124B/6G	59	639,00€
FG 124R/6G	59	639,00€
FG 124V/7G	59	689,00€
FG 124D/7G	59	689,00€
FG 124B/7G	59	689,00€
FG 124R/7G	59	689,00€
FG 124V/AS231	73	1.499,00€
FG 124D/AS231	73	1.499,00€
FG 124B/AS231	73	1.499,00€
FG 124R/AS231	73	1.499,00€
FG 124V/AS322	86	1.599,00€

CÓDIGO	PÁGINA	€/PROMO
FG 124D/AS322	86	1.599,00€
FG 124B/AS322	86	1.599,00€
FG 124R/AS322	86	1.599,00€
FG 125/S3	27	41,90€
FG 125/LV	131	11,90€
FG 127/S1	25	29,90€
FG 128C/S6	25	27,90€
FG 128/2	100	349,00€
FG 128/D2	100	479,00€
FG 128/B2	100	479,00€
FG 128/R2	100	479,00€
FG 129/2	100	449,00€
FG 129/D2	100	579,00€
FG 129/B2	100	579,00€
FG 129/R2	100	579,00€
FG 129/1	101	289,00€
FG 129/D1	101	359,00€
FG 129/B1	101	359,00€
FG 129/R1	101	359,00€
FG 129/1.5	101	339,00€
FG 129/D1.5	101	419,00€
FG 129/B1.5	101	419,00€
FG 129/R1.5	101	419,00€
FG 130AL/S5	139	22,90€
FG 131/D2	102	899,00€
FG 131/B2	102	899,00€
FG 131/R2	102	899,00€
FG 132/200	27	11,90€
FG 132/300	27	12,90€
FG 132/500	27	13,90€
FG 132/800	27	17,90€
FG 132/1000	27	18,90€
FG 134/H800	27	13,90€
FG 134/H1000	27	14,90€
FG 134/H1250	27	15,90€
FG 134/H1500	27	18,90€
FG 134/H2000	27	22,90€
FG 137/D1.5	102	739,00€
FG 137/B1.5	102	739,00€
FG 137/R1.5	102	739,00€
FG 138/BP	16	35,90€
FG 138/M	16	37,90€
FG 138	16	29,90€
FG 138/B	16	17,90€
FG 138/C	16	19,90€
FG 139/B	15	9,90€
FG 139/C	15	13,90€
FG 139/LM	15	32,90€
FG 139	15	22,90€
FG 139/L	15	24,90€
FG 139/IN	15	22,90€
FG 150TX/S32	11	125,00€
FG 150M/S26	12	109,00€
FG 150H/S30	12	119,00€
FG 150D/5G	64	589,00€
FG 150R/5G	64	589,00€
FG 150D/6G	64	629,00€
FG 150R/6G	64	629,00€
FG 150D/7G	64	659,00€
FG 150R/7G	64	659,00€
FG 152/RTXS10	13	99,00€
FG 152RH/S9	13	69,00€
FG 152RM/S9	13	69,00€
FG 159/PM	132	139,00€
FG 160V/14L	63	1.699,00€
FG 160D/14L	63	1.699,00€

CÓDIGO	PÁGINA	€/PROMO
FG 160B/14L	63	1.699,00€
FG 160R/14L	63	1.699,00€
FG 162/S3	48	229,00€
FG 162/FR1	48	89,90€
FG 162/FR2	48	119,00€
FG 162/FR3	48	139,00€
FG 162V/14P	63	1.799,00€
FG 162D/14P	63	1.799,00€
FG 162B/14P	63	1.799,00€
FG 162R/14P	63	1.799,00€
FG 162V/AS288	87	2.799,00€
FG 162D/AS288	87	2.799,00€
FG 162B/AS288	87	2.799,00€
FG 162R/AS288	87	2.799,00€
FG 165/IE1	48	189,00€
FG 165/IE2	48	459,00€
FG 165/MB1	49	99,00€
FG 165/MB2	49	199,00€
FG 165/S26	132	459,00€
FG 165/BC1	145	28,90€
FG 165/BC3	145	42,90€
FG 165BC/S6	145	139,00€
FG 166/S7	132	329,00€
FG 166/S28	132	299,00€
FG 168/EF1	48	195,00€
FG 168/EF2	48	205,00€
FG 168SD/S4	49	95,00€
FG 168A/S5	49	69,00€
FG 168A/S13	49	129,00€
FG 168EP/S5	49	19,90€
FG 168/S25	49	79,00€
FG 168/S9	49	119,00€
FG 168/GA	132	37,90€
FG 168/S7	132	169,00€
FG 171/B	135	28,90€
FG 171/FL	135	29,90€
FG 172/FA2	134	53,90€
FG 172/FA	134	39,90€
FG 172/PA	134	42,90€
FG 172/MA	134	59,90€
FG 172/AS2	134	69,90€
FG 172/TC	134	19,90€
FG 172/TG	134	23,90€
FG 172/GO2	135	62,90€
FG 172/OT	135	33,90€
FG 172/S4	135	19,90€
FG 172/CA	135	34,90€
FG 174/F2	129	43,50€
FG 174/SC	129	74,90€
FG 175/FO74.5-8	124	29,90€
FG 175/HI	124	39,90€
FG 175/S30	124	129,00€
FG 175/FO84	124	33,90€
FG 175/OP1	124	27,90€
FG 175/S6	124	39,90€
FG 175/S15	125	79,90€
FG 175/PR	125	23,90€
FG 175/S114	125	159,00€
FG 175/FT2	128	49,90€
FG 175/FT4	128	42,90€
FG 175/FT1	128	39,90€
FG 175/FT3	128	51,90€
FG 175/FT5	128	42,90€
FG 176/S13	126	259,00€
FG 178/UF83	125	20,90€
FG 178/FL	125	28,90€

CÓDIGO	PÁGINA	€/PROMO
FG 178/UF110	125	69,00€
FG 178/UF145	125	99,00€
FG 178/SF	130	899,00€
FG 178SF/AD13	130	35,90€
FG 178SF/AD14	130	35,90€
FG 178/S6	130	189,00€
FG 178/BF	131	149,00€
FG 179/S16	129	89,00€
FG 180/SP9	5	129,00€
FG 180/S12	130	51,90€
FG 180/S17	130	199,00€
FG 180/S38	130	419,00€
FG 181/PM2	134	49,00€
FG 182/S5B	49	285,00€
FG 182/S14	49	149,00€
FG 182/S16	129	319,00€
FG 182/RG10	141	11,90€
FG 182/RG24	141	15,90€
FG 183/S5	129	69,00€
FG 183/RV1	141	12,90€
FG 183/CM	144	29,90€
FG 183/CK250	144	12,90€
FG 183/CK450	144	19,90€
FG 183/CK600	144	25,90€
FG 183/RA1	144	15,90€
FG 184/S5	135	99,00€
FG 184R/S3	139	27,90€
FG 184/R2	139	13,90€
FG 184P/S3	139	15,90€
FG 184/R1	139	12,90€
FG 185/S5	140	59,00€
FG 185B/S2	140	24,90€
FG 185P/S4	140	16,90€
FG 185/CR	141	5,90€
FG 185/RM	141	18,90€
FG 185/OM	141	18,90€
FG 186/S11	139	69,00€
FG 186/S3	140	6,90€
FG 186/S3B	140	6,90€
FG 186P/S5	140	19,90€
FG 186/AL1	140	14,90€
FG 186/S5	140	58,90€
FG 186/S4	141	15,90€
FG 187/GU	142	17,90€
FG 187/S7	142	139,00€
FG 187/GR	142	17,90€
FG 187/GU2	142	16,90€
FG 187/K25	142	28,90€
FG 187/S2	145	439,00€
FG 187/K40	145	119,00€
FG 187/K30	145	43,90€
FG 187/PN	145	169,00€
FG 188P/S2	139	24,90€
FG 188/P1	140	11,90€
FG 188P/S4	145	42,90€
FG 189/S13	129	159,00€
FG 189/PO1	141	12,90€
FG 189/PO2	141	23,90€
FG 190/S6B	128	99,00€
FG 191/S22	127	389,00€
FG 191/S24	127	299,00€
FG 191/S14	128	89,00€
FG 193DSG/S9	137	629,00€
FG 193/DCT	137	99,00€
FG 193/DS1	137	19,90€
FG 193/DS2	137	19,90€

CÓDIGO	PÁGINA	€/PROMO
FG 193/S4	137	299,00€
FG 193/ATJ	137	26,90€
FG 193/MB	137	39,00€
FG 194/TS	137	21,90€
FG 198/S11	131	82,90€
FG 198/PE	135	37,90€
FG 199/PF	131	139,00€
FG 199/SF	131	37,90€
FG 201	34	29,90€
FG 201/S7	126	209,00€
FG 202	34	33,90€
FG 203	32	12,90€
FG 203/S20	126	209,00€
FG 203/BW1	126	21,90€
FG 203/FO1	126	21,90€
FG 203/FO2	126	21,90€
FG 203/FT1	126	26,90€
FG 203/OP1	126	21,90€
FG 203/TO1	126	22,90€
FG 203/S7	126	99,00€
FG 204	32	19,90€
FG 205/B	35	49,90€
FG 206	34	33,90€
FG 207	33	37,90€
FG 207/B	33	59,90€
FG 209	37	149,00€
FG 210/B	37	49,90€
FG 210/C	36	99,00€
FG 210/W	38	44,90€
FG 211	33	59,90€
FG 212	33	42,90€
FG 213/L480	32	39,90€
FG 213/DP	38	56,90€
FG 213/W	39	62,90€
FG 213/S3	39	165,90€
FG 213/LT	146	189,00€
FG 213/SM	146	449,00€
FG 214/L600	34	39,90€
FG 215/S40	136	899,00€
FG 217/B	35	169,00€
FG 219/S	136	1.999,00€
FG 220/BT	133	249,00€
FG 221	36	159,00€
FG 222/A	35	49,00€
FG 222/B	37	169,00€
FG 224/L5200	36	129,00€
FG 224/SU	36	49,00€
FG 225/SK1.5	41	159,00€
FG 225/SK2.5	41	179,00€
FG 234	40	59,00€
FG 235	40	79,00€
FG 236	41	199,00€
FG 236/SU	41	59,00€
FG 305/LT2	44	499,00€
FG 310/LT2	44	539,00€
FG 315/LT2	45	599,00€
FG 320/LT2	45	649,00€
FG 330/LT2	45	549,00€
FG 360/LT1	46	299,00€
FG 363/LT1	46	309,00€
FG 366/LT1	46	319,00€
FG 370/LT1	47	369,00€
FG 373/LT1	47	359,00€
FG 380/LT1	47	319,00€
FG 383/LT1	47	299,00€
FGA 290	51	119,00€

CÓDIGO	PÁGINA	€/PROMO
FGA 291/D	51	119,00€
FGA 292/B	51	139,00€
FGA 302	51	139,00€
FGA 307	50	149,00€
FGA 307/AN	50	189,00€
FGA 309	50	179,00€
FGA 309/S4	51	239,00€
FGA 309/S10	51	249,00€
FGA 312	50	199,00€
FGA 316	52	449,00€
FGA 316/L	52	499,00€
FGA 319	52	699,00€
FGA 319/L	52	799,00€
FGA 321	52	649,00€
FGA 321/B	52	669,00€
FGA 321/C	52	749,00€
FGA 322	53	85,00€
FGA 330	55	179,00€
FGA 332	53	89,00€
FGA 332/AN	53	109,00€
FGA 333/AC	53	129,00€
FGA 333	53	109,00€
FGA 334	56	89,00€
FGA 334/AN115	56	109,00€
FGA 334/AN	56	109,00€
FGA 334/L	56	109,00€
FGA 335	55	119,00€
FGA 336	55	379,00€
FGA 337	55	79,00€
FGA 338	56	75,00€
FGA 338/B	56	99,00€
FGA 338/AN	56	99,00€
FGA 338/L	56	99,00€
FGA 339	55	199,00€
FGA 340	54	169,00€
FGA 340/B	54	169,00€
FGA 341	54	399,00€
FGA 342/B	54	169,00€
FGA 342	54	129,00€
FGA 343/N10	54	139,00€
FGA 343/N20	54	179,00€
FGA 346/B	55	139,00€
FGA 383/AR15	57	149,00€
FGA 385/AR15	57	199,00€
FGA 390	53	89,00€
FGA 416	57	13,90€
FGA 419	57	14,90€
FG 491/200	126	23,90€
FG 491/1500	126	51,90€
FG 491/DF1500	126	79,90€
FG 493/AL	27	28,90€
FG 493/N	27	23,90€
FG 494/S12	26	33,90€
FG 494/A180	26	109,00€
FG 531	20	132,00€
FG 533/2	20	142,00€
FG 536/1-IS	18	439,00€
FG 536/1	20	145,00€
FG 536/2	20	149,00€
FG 536/3	20	169,00€
FG 538/1	20	499,00€
FG 538/2	20	559,00€
FG 539/1	20	699,00€
FG 540/1	20	629,00€
FG 540/2	20	719,00€
FG 543/DG1	21	399,00€



CÓDIGO	PÁGINA	€/PROMO
FG 543/DG2	21	469,00€
FG 546/DG	21	199,00€
FG 547/DG	21	125,00€
FG 559/1	21	129,00€
FG 559/2	21	139,00€
FG 581/A	21	499,00€
FG 581/B	21	799,00€
FG 600A/SC16	4	149,00€
FG 600A/SC25	4	229,00€
FG 600/SC16	4	139,00€
FG 600/SC25	4	209,00€
FG 600TW/S12	5	115,00€
FG 600XL/SC11	5	219,00€
FG 602/SC13	4	95,00€
FG 603/S28A	90	539,00€
FG 603/S28B	90	539,00€
FG 603/TA1	91	159,00€
FG 605/ST11-B	7	145,00€
FG 605/SC15	7	159,00€
FG 606/SP9	7	85,00€
FG 610FL/SP11	7	179,00€
FG 613/S11	5	139,00€
FG 614C/S8	5	139,00€
FG 615/SC8	5	69,90€
FG 615A/S6	7	75,00€
FG 618/S7B	6	159,00€
FG 618/S7	6	179,00€
FG 618/S10	6	249,00€
FG 621H/S8	6	85,00€
FG 621H/S8C	6	89,00€
FG 621H/S14	6	179,00€
FG 622A/S2	7	49,00€
FG 623H/S6	6	79,20€
FG 623H/S8	6	119,00€
FG 623H/S14	6	239,00€
FG 624/S25	8	49,90€
FG 624/S25A	8	49,90€
FG 624/S45	9	129,00€
FG 624B/S80	9	119,00€
FG 625/S27	9	109,00€
FG 625/S110	11	259,00€
FG 625AM/S3	13	29,90€
FG 628/S12	13	79,00€
FG 628/S6	13	55,00€
FG 628/S7	131	69,00€
FG 629A/S15	12	339,00€
FG 629B/S15	12	339,00€
FG 629C/S10	13	169,00€
FG 630A/S14	13	499,00€
FG 710/C	147	85,00€
FG 710/E	147	85,00€
FG 710/D	147	129,00€
FG 712/L4	25	49,00€
FG 712/A	25	19,90€
FG 718/2.5T	148	269,00€
FG 718/3.5T	148	299,00€
FG 719/2T	149	399,00€
FG 721/2T	149	479,00€
FG 722/5T	149	799,00€
FG 725/3T	144	55,90€
FG 725/6T	144	95,00€
FG 725/12T	144	169,00€
FG 735/4T	144	49,00€
FG 735/6T	144	55,00€
FG 735/10T	144	79,00€
FG 735/16T	144	89,00€

CÓDIGO	PÁGINA	€/PROMO
FG 735/20T	144	109,00€
FG 738/1T	146	599,00€
FG 740/0.5T	146	319,00€
FG 745/CMR	146	529,00€
FG 745/CMF	147	269,00€
FG 748/0.5T	144	139,00€
FG 750/A	144	249,00€
FG 750/1P	145	1.599,00€
FG 750/2P	145	1.899,00€
FG 752/1P	145	1.999,00€
FG 752/2P	145	2.199,00€
FG 1450	28	83,90€
FG 1452	28	89,00€
FG 1454	28	119,00€
FG 1456	29	149,00€
FG 1460	29	89,00€
FG 1465	29	119,00€



**FASANGAS S.r.l.**

**SEDE LEGALE E LOGISTICA**

Viale Grecia 3, lotto 18 - 73100 Zona Ind.le LECCE - ITALY

**SEDE PRODUTTIVA**

Viale Irlanda 3 - 73100 Zona Ind.le LECCE - ITALY

(+39) 0832.362097/364265

info@fasanotools.com



**FASANOTOOLS.COM**

**VALIDADE: 01-04-2025 / 01-03-2026**

