



ZAVAGLI



ERLO

Drills / Units / CNC



FomIndustrie
Aluminium Working Machinery



del'air
COMPRESSORES

FRIULAIR®



ZMM
BULGARIA

VESPA
SABBIATRICI



MEMODERIVA®
MÁQUINAS & EQUIPAMENTOS INDUSTRIAIS

www.memoderiva.pt

MÁQUINAS DE LAVAR



POLO BASE
BOMBA INTERPUMP
ÁGUA FRIA
COM TOTAL STOP



PWP 120/11M
2200V - 120BAR
660L/H - 11L/M
2.2KW - 65KG

PWP 120 / 11M
€ 1.790

PWP 160 / 15 T
380V - 160BAR
900L/H - 15L/M
4KW - 77KG
1450RPM / 5.5HP

PWP 160 / 15 T
€ 1.890

PWP 250 / 15 T
380V - 250BAR
900L/H - 15L/M
7.5KW - 92KG
1450RPM / 10HP

PWP 200 / 21 T
€ 2.440

PWP 200 / 21 T
380V - 200BAR
1260L/H - 21L/M
7.5KW - 92KG
1450RPM / 10HP

PWP 200 / 15 T
€ 1.960

PWP 200 / 15 T
380V - 200BAR
900L/H - 15L/M
5.5KW - 92KG
1450RPM / 7.5HP

PWP 250 / 15 T
€ 2.480



POLO COMPACT

PWPC 170/13 T
380 V - 170 BAR
780 L/H - 13 L/MIN
4 KW - 47 KG
1450 RPM / 5.5 HP

€ 1.590

PWPC 200/11 T
380 V - 200 BAR
900 L/H - 15 L/MIN
4 KW - 47KG
1450 RPM / 5.5 HP

€ 1.590

BOMBA INTERPUMP



POLO PETROL BASE - GASOLINA



BOMBA INTERPUMP

PWPP 250 / 15 B
250 BAR
900 L/H - 15 L/M
9.5 KW - 70 KG
3400 RPM / 13 HP
MOTOR HONDA
GASOLINA

PWPP 250 / 15 BB
€ 2.950

PWPP 200 / 15 B
200 BAR
900 L/H - 15 L/M
8 KW - 70 KG
3400 RPM / 11 HP
MOTOR HONDA
GASOLINA

PWPP 200 / 15 BB
€ 2.850

QUALIDADE PREÇO - EXCELENTE
MOTOR HONDA A GASOLINA A 3000 RPM
MODO DE BY PASS EM STAND-BY



POLO PETROL BASE - DIESEL



COM ARRANQUE AUTOMÁTICO
BOMBA INTERPUMP

PWPP 200 / 15 DB
200 BAR
900 L/H - 15 L/M
8 KW - 70 KG
3400 RPM / 10 HP
MOTOR DIESEL
YANMAR

PWPP200/15DB
€ 3.950



MÁQUINAS DELAVAR



POWERWASH - GOLDBASE ÁGUA QUENTE

PWGB 160/15T
380 V - 160 BAR
900 L/H - 15 L/MIN
4KW - 138 KG
1450 RPM / 5.5 HP
DIESEL - 90°C

PWGB 200/15T
380 V - 200 BAR
900 L/H - 15 L/MIN
5.5KW - 145 KG
1450 RPM / 7.5 HP
DIESEL - 90°C

PWGB 200/21T
380 V - 200 BAR
1260 L/H - 21 L/MIN
7.5KW - 160 KG
1450 RPM / 10 HP
DIESEL-90°C

PWGB 250/15T
380 V - 250 BAR
900 L/H - 15 L/MIN
7.5KW - 160 KG
1450 RPM / 10 HP
DIESEL-90°C



BOMBA INTERPUMP

€ 3.550

€ 3.550

€ 3.940

€ 3.940



POWERWASH - SILVER BASE ÁGUA QUENTE

PWSB 160/14T
380 V - 160 BAR
780 L/H - 14 L/MIN
4KW - 120 KG - 80°C
1450 RPM / 5.5 HP
QUEIMADOR A
DIESEL COM

PWSB 200/10T
380 V - 200 BAR
660 L/H - 10 L/MIN
4KW - 120 KG - 80°C
1450 RPM / 5.5 HP
QUEIMADOR A
DIESEL COM



BOMBA INTERPUMP

€ 2.920

€ 2.920



POWERWASH - POLO BASE

PWPP 300/21 T STR
400 V - 300 BAR
1260 L/H - 21 L/MIN
12.5KW - 250 KG
1450 RPM / 17 HP



PWPP 500/15 T STR
400 V - 500 BAR
900 L/H - 15 L/MIN
15KW - 350 KG
1450 RPM / 20 HP

€ 5.280

€ 7.450



BOMBA INTERPUMP



MÁQUINAS DE LAVAR

LAVADORA ALTA PRESSÃO

VERTIGO 28 PLUS

160 BAR MAX - 510 L/H MAX
2800 W - 230 V - 4 HP
8 METROS MANGUEIRA
5 METROS CABO ALIMENTAÇÃO
6 DE BICOS DE LIMPEZA DIFERENTES
1 ESCOVA REDONDA PARA PAVIMENTO
1 ESCOVA ROTATIVA
1 TUBO PARA LIMPAR TUBOS

8.047.0020

€ 595

LAVOR
SIMPLY STRONGER



MÁQUINA DE LAVAR PAVIMENTO

FREE EVO 50 B

COM CARREGADOR E BATERIA INCLUÍDOS
DISCO DE ESCOVA 500/800MM
TANQUE DE ASPIRAÇÃO 44 LT
MOTOR VACUO 400 W - 24 V
550 W DE POTENCIA NO MOTOR DA ESCOVA

8.527.0010 € 3.650

ACESSÓRIOS OPCIONAIS:



DISCO Ø483 PARA
DISCOS ABRASIVOS

5.511.2242 € 149

MÁQUINA DE LAVAR PAVIMENTO COM TRAÇÃO

FREE EVO 50 BT

COM CARREGADOR E BATERIA INCLUÍDOS
DISCO DE ESCOVA 500/800MM
TANQUE DE ASPIRAÇÃO 44 LT
MOTOR VACUO 400 W - 24 V
550W POTÊNCIA NO MOTOR DA ESCOVA
2000 M²/H

8.527.0012 € 4.190

ACESSÓRIOS INCLUÍDOS:



CARREGADOR BATERIA DISCO BORRACHA



FÁCIL DESPEJO DO DEPÓSITO
FILTRO DE ÁGUA
RODAS ANTI MARCAÇÃO DE PAVIMENTO
MUITO COMPACTA
IDEAL PARA ÁREAS ATÉ 1.500M²
BAIXO RUÍDO
AVANÇO AUTOMÁTICO 150W



LAVADORA CARRO CONFORT XXS 66 BT

GRANDES ÁREAS ATÉ 3200 M²

REDUÇÃO DE SIGNIFICATIVA DE CUSTOS DE LIMPEZA
PRESSÃO DAS ESCOVAS: 32KG | ESCOVA DUPLA CONTRA-ROTATIVA
AUTONOMIA: ATÉ 4.5 HORAS COM 4 BATERIAS 6V 240Ah
TANQUE GRANDE DE CARGA: 85 LT | RODA MOTOR TRASEIRA
SISTEMA DE DOSEAMENTO DE DETERGENTE AUTOMÁTICO
POTÊNCIA: 24 V | 2 X 400W
PESO 142 KG | DIMENSÕES: 123X63X212

ACESSÓRIOS INCLUÍDOS:

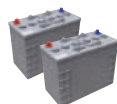

CARREGADOR 2XBATERIA 2XDISCO BORRACHA



8.579.0002

€ 8.490



LANÇA LAVAGEM SCP+AN28

Referência	Entrada	Saída	Pressão	Caudal	Temp.	Comp.	Preço
4030400001	M22x1,5 M	1/4 NPT F	280 bar	30 l/min	160°C	460 mm	23,20€

LANÇA ROTATIVA SC+TPR255

Referência	Entrada	Pressão	Caudal	Temp.	Bocal	Comp.	Preço
4042100004	M22x1,5 M	255 bar	11 l/min	160°C	03	463 mm	48,29€
4042100005	M22x1,5 M	255 bar	12,9 l/min	160°C	035	463 mm	
4042100007	M22x1,5 M	255 bar	16,3 l/min	160°	045	463 mm	

LANÇA ROTATIVA INOX

Referência	Entrada	Pressão	Caudal	Temp.	Bocal	Comp.	Preço
0202004400	M22x1,5 M	255 bar	11 l/min	100°C	03	470 mm	56,62€
0202004410	M22x1,5 M	255 bar	12,9 l/min	100°C	035	470 mm	
0202004420	M22x1,5 M	255 bar	14,5 l/min	100°C	04	470 mm	
0202004430	M22x1,5 M	255 bar	16,3 l/min	100°C	045	470 mm	
0202004440	M22x1,5 M	255 bar	18 l/min	100°C	05	470mm	
0202004450	M22x1,5 M	255 bar	20 l/min	100°C	055	470mm	

LANÇA CURVA MV 20/A + PU INOX

Referência	Entrada	Pressão	Caudal	Temp.	Comp.	Preço
0202000210	G 1/4 M	280 bar	40 l/min	150°C	900 mm	12,43€
0202000220	G 1/4 M	280 bar	40 l/min	150°C	1200 mm	15,52€

LANÇA DUPLA LD+MV30

Referência	Entrada	Saída	Pressão	Caudal	Temp.	Comp.	Preço
0202004711	M22x1,5 M	G 1/4 F	250 bar	40 l/min	150°C	565 mm	37,92€
0202004721	M22x1,5 M	G 1/4 F	250 bar	40 l/min	150°C	795 mm	44,23€

CABEÇA ROTATIVA - ROTOJET

Referência	Entrada	Pressão	Temp.	Bocal	Preço
0204007310	G 1/4 F	255 bar	100°C	025	43,73€
0204007320	G 1/4 F	255 bar	100°C	030	
0204007330	G 1/4 F	255 bar	100°C	035	
0204007340	G 1/4 F	255 bar	100°C	040	
0204007350	G 1/4 F	255 bar	100°C	045	
0204007360	G 1/4 F	255 bar	100°C	050	
0204007370	G 1/4 F	255 bar	100°C	055	
0204007380	G 1/4 F	255 bar	100°C	060	

**CABEÇA ROTATIVA ROTOJET**

Referência	Entrada	Pressão	Temp.	Bocal	Preço
0204006505	G 1/4 F	310 bar	100°C	055	60,07€

**CABEÇA ROTATIVA - ROTOJET**

Referência	Entrada	Pressão	Temp.	Bocal	Preço
0204006915	G 1/4 F	400 bar	90°C	045	96,23€

**CABEÇA IDROJET**

Referência	Entrada	Pressão	Temperatura	Ângulo	Bocal	Cor	Preço
0204008500	G 1/4 F	220 bar	150°	Variável	03		11,68€
0204008510	G 1/4 F	220 bar	150°	Variável	035		
0204008530	G 1/4 F	220 bar	150°	Variável	04		
0204008540	G 1/4 F	220 bar	150°	Variável	042		
0204008550	G 1/4 F	220 bar	150°	Variável	045		
0204008560	G 1/4 F	220 bar	150°	Variável	05		
0204008570	G 1/4 F	220 bar	150°	Variável	055		
0204008590	G 1/4 F	220 bar	150°	Variável	060		

**KIT REPARAÇÃO ROTOJET**

Referência	Entrada	Pressão	Ângulo	Bocal	Preço
0204107320	G 1/4 F	255 bar	20°	03	29,94€
0204107330	G 1/4 F	255 bar	20°	035	
0204107340	G 1/4 F	255 bar	20°	04	
0204107350	G 1/4 F	255 bar	20°	045	
0204107360	G 1/4 F	255 bar	20°	05	
0204107370	G 1/4 F	255 bar	20°	055	



PUNHO AI55

Referência	Entrada	Saída	Pressão	Caudal	Temp.	Preço
4012209007	G 3/8 F	G 1/4 F	350 bar	45 l/min	160°C	23,51€
4012209013	M22x1,5 M	G 1/4 F	350 bar	45 l/min	160°C	25,52€

PUNHO MV951 SWIVEL STD

Referência	Entrada	Saída	Pressão	Caudal	Temp.	Preço
4012206002	M22x1,5 M	G 1/4 F	350 bar	40 l/min	150°C	32,82€
4012206005	G 3/8 F	G 1/4 F	350 bar	40 l/min	150°C	

PUNHO COMPLETO MV 925 MV70

Referência	Entrada	Saída	Pressão	Caudal	Temp.	Preço
4022105010	G 3/8 M	M22x1,5 M	310 bar	30 l/min	160°C	32,82€
4022105011	M22x1,5 M	M22x1,5 M	310 bar	30 l/min	160°C	

PUNHO COMPLETO MV 925 SW TOP L35

Referência	Entrada	Saída	Pressão	Caudal	Temp.	Preço
4022205006	M22x1,5 M	M22x1,5 F	310 bar	30 l/min	160°C	47,27€

PUNHO COMPLETO MV 2009

Referência	Entrada	Saída	Pressão	Caudal	Temp.	Preço
4021109006	M22x1,5 M	M22x1,5 F	275 bar	30 l/min	100°C	21,87€
4021109013	G 3/8 M	M22x1,5 F	275 bar	30 l/min	100°C	

KIT JACTO AREIA TS 14

Referência	Entrada	Pressão	Temp.	Caudal	Bocal	Bico	Preço
4058000009	M 22x1,5	140 bar	60°C	9,4 l/min	035	1,3	44,88€

KIT JACTO AREIA TS 33

Referência	Entrada	Pressão	Temp.	Caudal	Bocal	Bico	Preço
0202903450	M 22x1,5 M	250 bar	90°C	10,8 l/min	03	1,2	93,42€
0202903480	M22x1,5 M	250 bar	90°C	16,2 l/min	045	1,5	

BICO PRESSÃO CERÂMICA



Referência	Conector	Pressão	Caudal	Temp.	Bico	Ângulo	Preço
0124002200	1/4 NPT M	350 bar	12,8 l/min	150°C	03	0°	8,91€
0124002210	1/4 NPT M	350 bar	12,8 l/min	150°C	03	15°	
0124002220	1/4 NPT M	350 bar	12,8 l/min	150°C	03	25°	
0124002310	1/4 NPT M	350 bar	14,9 l/min	150°C	035	15°	
0124002320	1/4 NPT M	350 bar	14,9 l/min	150°C	035	25°	
0124002410	1/4 NPT M	350 bar	17,1 l/min	150°C	04	15°	
0124002420	1/4 NPT M	350 bar	17,1 l/min	150°C	04	25°	
0124002510	1/4 NPT M	350 bar	19,2 l/min	150°C	045	15°	
0124002520	1/4 NPT M	350 bar	19,2 l/min	150°C	045	25°	
0124002610	1/4 NPT M	350 bar	21,3 l/min	150°C	05	15°	
0124002620	1/4 NPT M	350 bar	21,3 l/min	150°C	05	25°	
0124002710	1/4 NPT M	350 bar	23,5 l/min	150°C	055	15°	
0124002720	1/4 NPT M	350 bar	23,5 l/min	150°C	055	25°	
0124002810	1/4 NPT M	350 bar	25,6 l/min	150°C	06	15°	
0124002820	1/4 NPT M	350 bar	25,6 l/min	150°C	06	25°	
0124002910	1/4 NPT M	350 bar	27,7 l/min	150°C	065	15°	
0124002920	1/4 NPT M	350 bar	27,7 l/min	150°C	065	25°	

MEG

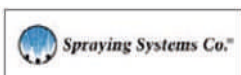

BICO ALTA PRESSÃO INOX

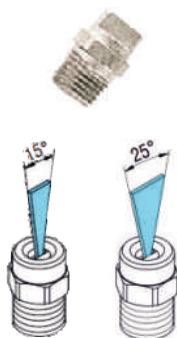

Referência	Conector	Pressão	Caudal	Temp.	Bico	Ângulo	Preço
0124720862	1/4 NPT M	280 bar	9,5 l/min	150°C	025	15°	10,08€
0124720872	1/4 NPT M	280 bar	11,4 l/min	150°C	03	15°	
0124720870	1/4 NPT M	280 bar	11,4 l/min	150°C	03	25°	
0124720882	1/4 NPT M	280 bar	13,3 l/min	150°C	035	15°	
0124720880	1/4 NPT M	280 bar	13,3 l/min	150°C	035	25°	
0124720892	1/4 NPT M	280 bar	15,3 l/min	150°C	04	15°	
0124720890	1/4 NPT M	280 bar	15,3 l/min	150°C	04	25°	
0124720902	1/4 NPT M	280 bar	17,2 l/min	150°C	045	15°	
0124720900	1/4 NPT M	280 bar	17,2 l/min	150°C	045	25°	
0124720912	1/4 NPT M	280 bar	19,1 l/min	150°C	05	15°	
0124720910	1/4 NPT M	280 bar	19,1 l/min	150°C	05	25°	
0124720922	1/4 NPT M	280 bar	21 l/min	150°C	055	15°	
0124720920	1/4 NPT M	280 bar	21 l/min	150°C	055	25°	

MEG

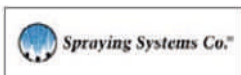

BICO ALTA PRESSÃO INOX



Referência	Conector	Pressão	Caudal	Temp.	Bico	Ângulo	Preço
0124723250	1/4 NPT M	350 bar	12,8 l/min	150°C	03	15°	4,31€
0124723260	1/4 NPT M	350 bar	14,9 l/min	150°C	035	15°	
0124723410	1/4 NPT M	350 bar	14,9 l/min	150°C	035	25°	
0124723270	1/4 NPT M	350 bar	17,1 l/min	150°C	04	15°	
0124723280	1/4 NPT M	350 bar	19,2 l/min	150°C	045	15°	
0124723430	1/4 NPT M	350 bar	19,2 l/min	150°C	045	25°	
0124720882	1/4 NPT M	350 bar	21,3 l/min	150°C	05	15°	





ASPIRADOR CUBA INOX

3 MOTORES
78 LITROS
220 V - 3600 W

E2375 MS

€ 615

2 MOTORES
77 LITROS
220 V - 2400 W

E2220 MS

€ 510

1 MOTOR
23 LITROS
220 V - 1400 W

E 2125 S

€ 250



ASPIRADOR CUBA ABS

3 MOTORES
78 LITROS
220 V - 3600 W

E 2375 MP

€ 499

2 MOTORES
77 LITROS
220 V - 2400 W

E 2220 MP

€ 408



ASPIRADOR COM EXTRACÇÃO

COM EXTRAÇÃO PARA LIXADEIRA
LIGAÇÃO ELÉTRICA E PNEUMÁTICA
76 LITROS - CUBA EM INOX
220 V - 2600 W - 2 MOTORES

E2VI125EAS

€ 710

E2EB250EAS

€ 729



MÁQUINA DE LAVAR ESTOFOS

2 MOTORES
76 LITROS
CUBA EM INOX
220 V - 2600 W

E 2250 LVS

€ 780



ASPIRADOR ALL BLACK

1 MOTOR
76 LITROS - CUBA EM INOX
220 V - 1700 W
DEPÓSITO INDEPENDENTE
COM RODAS

BL175EAS

€ 790





Ø40 INTERNO
ROSCA TUBO 48
305 COMPRIMENTO

ACIM040C/R € 10,31



Ø45 INTERNO
Ø50 EXTERNO
ALTURA DO PELO 30MM

ACPE040 € 4,82



400MM COMPRIDO
COM RODAS
Ø44 EXT Ø38 INT

ACCS400A/P € 10,21



ESCOVA SÓLIDOS
400MM COMPRIDO
PARA SUPORTE

ACIP400 € 9,48



400MM COMPRIDO
COM ESCOVA
Ø48 EXT Ø38 INT

ACCS400F € 19,75



Ø48 INT
Ø53EXT
ROSCA TUBO Ø48

ACMA048F € 8,56



285 COMPRIMENTO
100 LARGURA
Ø40 EXT - Ø35 INT

ACSP036 € 24,81



TUBO FLEXÍVEL
38MM
2,5 MTS COMPRIMENTO

ACTF38/2,5/C € 28,44



CESTO
PARA
FILTRO

CPTF252 € 17,96



FILTRO
LÍQUIDOS

ACCA165A € 11,75



JOGO 5 FILTROS
POLYESTER

FI005P/5

€ 74,96



JOGO
10 SACOS

FI003C/10

€ 21,33



FILTRO C/ ARO

FA044P

€ 41

RENNER
Kompressoren

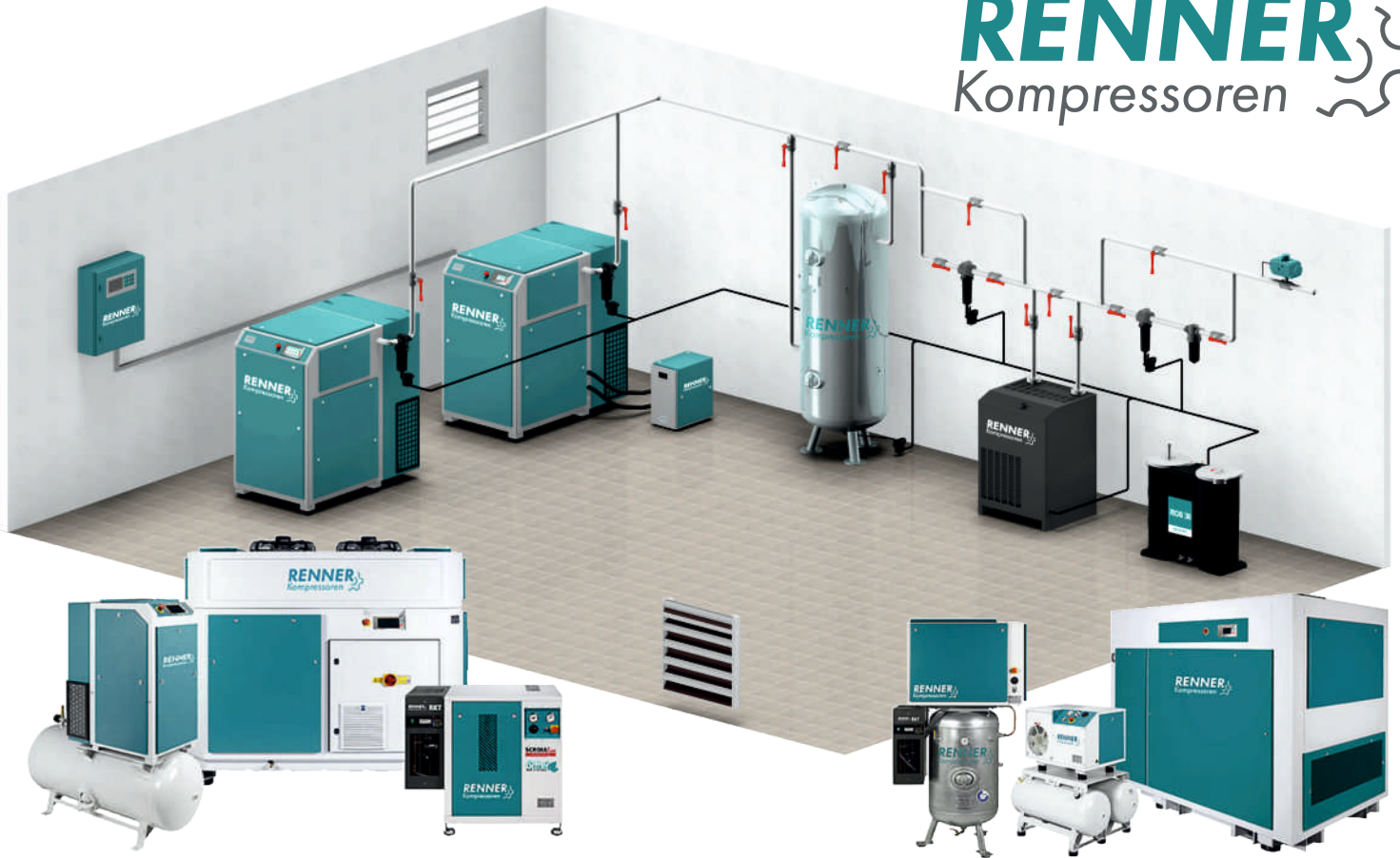

AR COMPRIMIDO

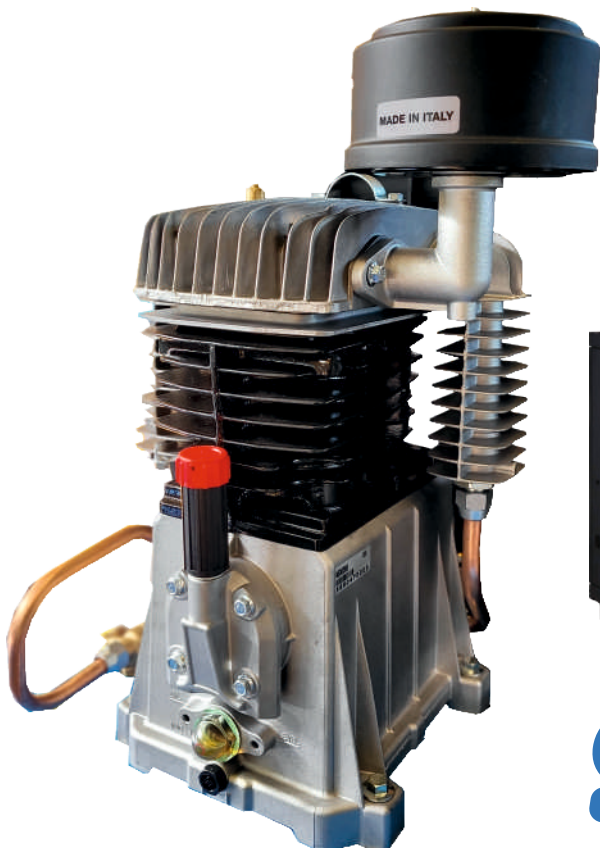

del'air
COMPRESSORES

made in italy



COMPRESSOR DE PARAFUSO

RS-PRO 7.5 KW

7.5 KW | 10 HP
7.5 bar 1.25 M³/MIN CFM 44
10 bar 1.09 M³/MIN CFM 39
13 bar 0.86 M³/MIN CFM 30
15 bar 0.79 M³/MIN CFM 28

SAÍDA 1/2"

€ 6.670

RENNER
Kompressoren

RS-PRO 11.0 KW

11 KW | 15 HP
7.5 bar 1.61 M³/MIN CFM 57
10 bar 1.56 M³/MIN CFM 55
13 bar 1.29 M³/MIN CFM 46
15 bar 1.11 M³/MIN CFM 39

SAÍDA 1/2"

€ 7.800

RS-PRO 15 KW

15 KW | 20 HP
7.5 bar 2.67 M³/MIN CFM 94
10 bar 2.31 M³/MIN CFM 82
13 bar 1.86 M³/MIN CFM 66
15 bar 1.69 M³/MIN CFM 60

SAÍDA 3/4"

€ 9.490

RS-PRO 2-18.5 KW

18.5 KW | 25 HP
7.5 bar 3.41 M³/MIN CFM 121
10 bar 2.91 M³/MIN CFM 103
13 bar 2.40 M³/MIN CFM 85
15 bar 2.06 M³/MIN CFM 73

SAÍDA 1"

€ 11.090



RS-PRO 22 KW

22 KW | 29.5 HP
7.5 bar 3.93 M³/MIN CFM 139
10 bar 3.44 M³/MIN CFM 122
13 bar 2.72 M³/MIN CFM 96
15 bar 2.51 M³/MIN CFM 89

SAÍDA 1"

€ 11.630

RS-PRO 30 KW

30 KW | 40 HP
7.5 bar 5.15 M³/MIN CFM 182
10 bar 4.51 M³/MIN CFM 159
13 bar 3.97 M³/MIN CFM 140
15 bar 3.55 M³/MIN CFM 125

SAÍDA 1.1/4"

€ 13.900

RS-PRO 37 KW

37 KW | 49.5 HP
7.5 bar 5.54 M³/MIN CFM 196
10 bar 5.23 M³/MIN CFM 185
13 bar 4.39 M³/MIN CFM 155
15 bar 4.08 M³/MIN CFM 144

SAÍDA 1.1/4"

€ 14.360

RS-PRO 45 KW

45 KW | 60.5 HP
7.5 bar 7.70 M³/MIN CFM 272
10 bar 6.92 M³/MIN CFM 245
13 bar 5.71 M³/MIN CFM 202
15 bar 4.99 M³/MIN CFM 176

SAÍDA 1.1/2"

€ 21.390

RS-PRO 55 KW

55 KW | 75 HP
7.5 bar 9.02 M³/MIN CFM 319
10 bar 7.94 M³/MIN CFM 281
13 bar 6.93 M³/MIN CFM 245
15 bar 6.09 M³/MIN CFM 215

SAÍDA 1.1/2"

€ 23.590



COMPRESSORES DE PARAFUSO

COMPRESSOR DE PARAFUSO COM VARIADOR DE FREQUÊNCIA
+ DE 35% POUPANÇA NA ENERGIA



RSF-PRO 7.5 KW

7.5 KW | 10 HP
6 bar 1.37 M³/MIN CFM 48
8 bar 1.24 M³/MIN CFM 44
10 bar 1.09 M³/MIN CFM 39
13 bar 0.43-.86 M³/MIN CFM 15-30
15 bar 0.40-0.79 M³/MIN CFM 14-28

SAÍDA 1/2"

€ 10.500

RSF-PRO 11 KW

11 KW | 15 HP
6 bar 1.64 M³/MIN CFM 58
8 bar 1.60 M³/MIN CFM 57
10 bar 1.56 M³/MIN CFM 55
13 bar 0.65-1.29 M³/MIN CFM 23-46
15 bar 0.56-1.11 M³/MIN CFM 20-39

SAÍDA 1/2"

€ 12.580

RSF-PRO 15 KW

15 KW | 20 HP
6 bar 2.74 M³/MIN CFM 97
8 bar 2.57 M³/MIN CFM 91
10 bar 2.31 M³/MIN CFM 82
13 bar 0.93-1.86 M³/MIN CFM 33-66
15 bar 0.84-1.69 M³/MIN CFM 30-60

SAÍDA 3/4"

€ 15.330

RSF-PRO 18.5 KW

18.5 KW | 25 HP
6 bar 2.82 M³/MIN CFM 100
8 bar 2.64 M³/MIN CFM 93
10 bar 2.45 M³/MIN CFM 87
13 bar 0.98-1.96 M³/MIN CFM 35-69
15 bar 0.89-1.78 M³/MIN CFM 31-63

SAÍDA 3/4"

€ 15.980

RSF-PRO 2-18.5 KW

18.5 KW | 25 HP
6 bar 3.98 M³/MIN CFM 141
8 bar 3.55 M³/MIN CFM 125
10 bar 3.20 M³/MIN CFM 113
13 bar 1.21-2.57 M³/MIN CFM 43-91
15 bar 1.16-2.27 M³/MIN CFM 41-80

SAÍDA 1"

€ 17.840



RSF-PRO 22 KW

22 KW | 29.5 HP
6 bar 4.40 M³/MIN CFM 155
8 bar 3.99 M³/MIN CFM 141
10 bar 3.54 M³/MIN CFM 125
13 bar 1.24-2.93 M³/MIN CFM 44-103
15 bar 1.18-2.68 M³/MIN CFM 42-95

SAÍDA 1"

€ 18.430

RSF-PRO 30 KW

30 KW | 40 HP
6 bar 5.60 M³/MIN CFM 198
8 bar 5.09 M³/MIN CFM 180
10 bar 4.51 M³/MIN CFM 159
13 bar 1.92-3.90 M³/MIN CFM 68-138
15 bar 1.84-3.54 M³/MIN CFM 65-125

SAÍDA 1.1/4"

€ 21.930

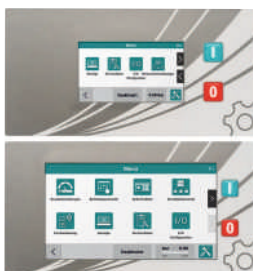

RSF-PRO 37 KW

37 KW | 49.5 HP
6 bar 5.77 M³/MIN CFM 204
8 bar 5.49 M³/MIN CFM 194
10 bar 5.30 M³/MIN CFM 187
13 bar 1.94-4.60 M³/MIN CFM 69-162
15 bar 1.89-4.16 M³/MIN CFM 67-147

SAÍDA 1.1/4"

€ 23.520

RSF-PRO 45 KW

45 KW | 60.5 HP
6 bar 8.32 M³/MIN CFM 294
8 bar 7.63 M³/MIN CFM 270
10 bar 6.86 M³/MIN CFM 242
13 bar 1.69-5.71 M³/MIN CFM 60-201
15 bar 1.45-4.99 M³/MIN CFM 51-175

SAÍDA 1.1/2"

€ 32.080



COMPRESSORES DE PARAFUSO



COMPRESSOR DE PARAFUSO COM VARIADOR DE FREQUÊNCIA
+ DE 35% POUPANÇA NA ENERGIA

RSF-PRO 55 KW

55 KW | 74 HP
6 bar 8.79M³/MIN CFM 311
8 bar 8.27 M³/MIN CFM 292
10 bar 7.74 M³/MIN CFM 274
13 bar 2.01-6.93 M³/MIN CFM 71-245
15 bar 1.73-6.09 M³/MIN CFM 61-123

SAÍDA 2"

€ 35.920

RSF 75 KW

75 KW | 100 HP
6 bar 12.83 M³/MIN CFM 453
8 bar 11.59 M³/MIN CFM 410
10 bar 10.35 M³/MIN CFM 366
13 bar 3.66-9.20M³/MIN CFM 129-325
15 bar 3.23-8.10 M³/MIN CFM 114-286

SAÍDA 2"

€ 41.090



LINHAS DE AR COMPRIMIDO

PROCURE A MELHOR DISTRIBUIÇÃO DE AR COMPRIMIDO PARA A SUA INDÚSTRIA E OBTENHA OS MELHORES RESULTADOS. MANTENHA A SUA LINHA SEM FUGAS, E GASTE APENAS O NECESSÁRIO. FALE CONNOSCO.

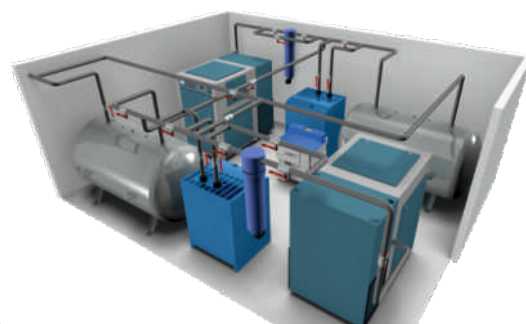
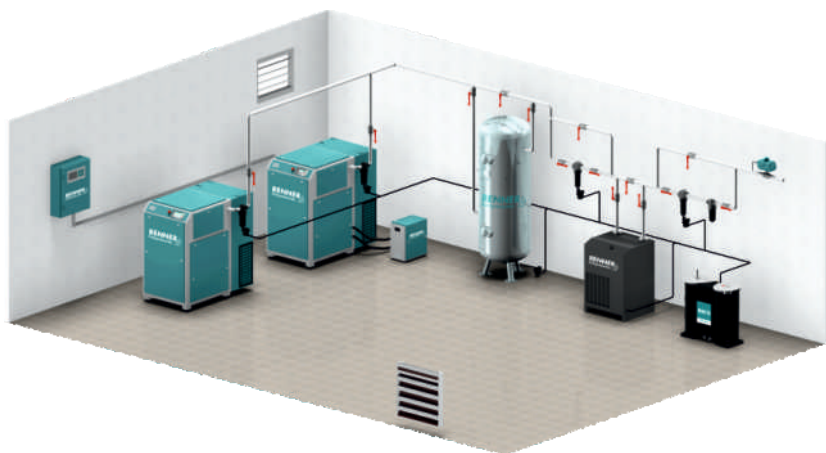

PERMUTADOR DE CALOR - 94% DE EFICIÊNCIA

OTIMIZE AO MÁXIMO O SEU COMPRESSOR, APROVEITANDO O CALOR GERADO COM A PRODUÇÃO DO AR, TORNANDO SUPER EFICIENTE O PROCESSO.

PERMUTADOR RENNER

€ SOB CONSULTA



COMPRESSORES DE PARAFUSO

COMPRESSOR DE TRANSMISSÃO DIRETA
COM VARIADOR DE FREQUÊNCIA



RSF-PRO 3-11.0D

11 KW | 15 HP
6 bar 2.39 M³/MIN CFM 84
8 bar 2.20 M³/MIN CFM 78
10 bar 2.02 M³/MIN CFM 71

SAÍDA 1"

€ 16.490

EQUADOS COM:
RENNER TRONNIC TOUCH



RSF-PRO 2-15.0D

15 KW | 20 HP
6 bar 3.33 M³/MIN CFM 118
8 bar 3.09 M³/MIN CFM 109
10 bar 2.86 M³/MIN CFM 101
13 bar 2.53 M³/MIN CFM 89
15 bar 2.28 M³/MIN CFM 81

SAÍDA 1"

€ 17.060

RSF-PRO 2-18.5D

18.5 KW | 25 HP
6 bar 4.00 M³/MIN CFM 141
8 bar 3.71 M³/MIN CFM 131
10 bar 3.42 M³/MIN CFM 121
13 bar 2.98 M³/MIN CFM 105
15 bar 2.69 M³/MIN CFM 95

SAÍDA 1"

€ 20.780

RSF-PRO 2-22.0D

22 KW | 29.5 HP
6 bar 4.42 M³/MIN CFM 156
8 bar 4.06 M³/MIN CFM 143
10 bar 3.71 M³/MIN CFM 131
13 bar 3.19 M³/MIN CFM 113
15 bar 2.75 M³/MIN CFM 97

SAÍDA 1"

€ 23.180

RSF-PRO 2-30D

30 KW | 40 HP
6 bar 5.42 M³/MIN CFM 192
8 bar 5.19 M³/MIN CFM 183
10 bar 4.71 M³/MIN CFM 166
13 bar 4.02 M³/MIN CFM 142

SAÍDA 1.1/4"

€ 27.600

RSF-PRO 2-37D

37 KW | 50 HP
6 bar 6.83 M³/MIN CFM 241
8 bar 6.29 M³/MIN CFM 222
10 bar 5.83 M³/MIN CFM 206
13 bar 5.11 M³/MIN CFM 181
15 bar 4.62 M³/MIN CFM 163

SAÍDA 1.1/4"

€ 30.400

RSF-PRO 45.0D

45 KW | 60 HP
6 bar 8.38 M³/MIN CFM 296
8 bar 7.69 M³/MIN CFM 272
10 bar 6.92 M³/MIN CFM 245
13 bar 5.87 M³/MIN CFM 207
15 bar 5.46 M³/MIN CFM 193

SAÍDA 1.1/2"

€ 34.940

RS-PRO 55.0D

55 KW | 75 HP
6 bar 9.21 M³/MIN CFM 325
8 bar 8.69 M³/MIN CFM 307
10 bar 8.17 M³/MIN CFM 289
13 bar 7.37 M³/MIN CFM 260
15 bar 6.92 M³/MIN CFM 245

SAÍDA 1.1/2"

€ 38.845

SISTEMA DE AQUECIMENTO DE ÁGUA

PERMUTADOR DE CALOR, QUE ARREFECE O ÓLEO DO COMPRESSOR E AQUECE ÁGUA PARA USO NAS DIVERSAS APLICAÇÕES INCLUÍDO AQS (ÁGUAS QUENTES SANITÁRIAS).

OPCIONAL EM
TODOS OS MODELOS

- Água quente
- Sistema de aquecimento
- Sistema de arrefecimento



COMPRESSORES DE TRANSMISSÃO DIRETA

del'air
COMPRESSORES



N50000C

€ 720

2 CILINDROS - 11 BAR MAX
MOTOR 5.5 HP - 4 KW - NB5
660 L/MIN - 1100 RPM



N10002A

€ 1.290

2 CILINDROS - 11 BAR MAX - NB10
MOTOR 10 HP - 7.5 KW - 1130 L/MIN - 900 RPM

N70001C

€ 890

2 CILINDROS - 11 BAR MAX - NB7
MOTOR 7.5 HP - 5.5 KW - 950 L/MIN - 750 RPM



2800000

€ 290

2 CILINDROS - 10 BAR MAX - B2800
MOTOR 2 HP - 1.5 KW - 254 L/MIN - 1250 RPM
MOTOR 3 HP - 2.2 KW - 320 L/MIN - 1570 RPM



370000B

3 HP/ 4HP

€ 410

2 CILINDROS - 10 BAR MAX - B3800
MOTOR 3 HP - 2.2 KW - 387 L/MIN - 1100 RPM
MOTOR 4 HP - 3 KW - 476 L/MIN - 1400 RPM

COMPRESSOR TRANSMISSÃO DIRETA

FCBB404ABC
COM ÓLEO
6 LITROS - 2850 RPM
220 V - 2 HP - 8 BAR
ASPIRAÇÃO 220 LT / MIN

€ 134



RCCC404 - 25 KG
COM ÓLEO - 2850 RPM
24 LITROS - RC2/24
220 V - 2 HP - 8 BAR
ASPIRAÇÃO 210 LT / MIN

€ 189



RCDV404 - 36 KG
COM ÓLEO - 2850 RPM
50 LITROS - RC2/50
220 V - 2 HP - 8 BAR
ASPIRAÇÃO 210 LT / MIN

€ 249



COMPRESSOR TRANSMISSÃO POR CORREIAS



B2800/50 CM2
2 CILINDROS EM FERRO FUNDIDO
50 LT - 1250 RPM - CABEÇA EM ALUMINIO
220 V - 2 HP - 10 BAR - 50 LT
ASPIRAÇÃO 255 LT / MIN

€ 550 28DC404 - 220 V

del'air



B2800/100 CM2 - B2800/100 CT2
2 CILINDROS EM FERRO FUNDIDO
100 LT - 1250 RPM - CABEÇA EM ALUMINIO
2 HP - 10 BAR - 100 LT
ASPIRAÇÃO 255 LT / MIN

€ 554 28FC404 - 220 V

€ 565 28FC441- 400 V



del'air



B3800B/200 CM3 - B3800B/200 CT3
2 CILINDROS EM FERRO FUNDIDO
200 LT - 1200/1570 RPM - CABEÇA EM ALUMINIO
3 HP - 10 BAR - 200 LT
ASPIRAÇÃO 390 LT / MIN

€ 768 36LC504 - 220 V

€ 817 36LC541 - 400 V



COMPRESSOR TRANSMISSÃO POR CORREIAS

B3800B/270 CT4
2 CILINDROS EM FERRO FUNDIDO
270 LT - 1400 RPM - CABEÇA EM ALUMINIO
4 HP - 10 BAR
400 V - 270 LT
ASPIRAÇÃO 480 LT / MIN

36NC601 € 942



del'air

NB5/5.5CT/270
2 CILINDROS EM FERRO FUNDIDO
270 LT - 1370 RPM
CABEÇA EM ALUMINIO NS39
BISTADIO - 5.5 HP
400 V - 10 BAR - 270 LT
ASPIRAÇÃO 582 LT / MIN

N5NC701 € 1.490



del'air

NB7/7.5CT/270
2 CILINDROS EM FERRO FUNDIDO
270 LT - 1450 RPM
CABEÇA EM ALUMINIO NS59
BISTADIO - 7.5 HP
400 V - 10 BAR - 270 LT
ASPIRAÇÃO 860 LT / MIN

N7NC801 € 1.650



del'air

NB10/10CT/270
2 CILINDROS EM FERRO FUNDIDO
270 LT - 950 RPM
CABEÇA EM ALUMINIO NS59S
BISTADIO - 10 HP
400 V - 10 BAR
ASPIRAÇÃO 1230 LT / MIN

N1NC901 € 2.130



COMPRESSORES DE PISTON

O compressor DEL'AIR® de 3+3 vem equipado com dois motores independentes e dois térmicos.

O compressor DEL'AIR® de 4+4 vem equipado com dois motores e centralina de arranque temporizado.



36NW541

€ 1.600

B3800/270FT3+3TD
2 CILINDROS EM FERRO FUNDIDO
270 LT - 1300 RPM
CABEÇA EM ALUMÍNIO NS39S
3 + 3 HP
400 V - 10 BAR
ASPIRAÇÃO 780 LT / MIN



36NW601

€ 1.960

B3800B/270FT4+4 TD
2 CILINDROS EM FERRO FUNDIDO
270 LT - 1450 RPM
CABEÇA EM ALUMÍNIO NS59S
4 + 4 HP BISTADIO
400 V - 10 BAR
ASPIRAÇÃO 960 LT / MIN



B3800B/270 FM3+3 TD
2 CILINDROS EM FERRO FUNDIDO
270 L - 1 100 RPM
CABEÇA EM ALUMÍNIO
3+3 HP
220V - 10 BAR
ASPIRAÇÃO - 780L/MIN

€ 2.250

BORRACHA PARA VÁLVULAS DE RETENÇÃO EM SILICONE



Referência	Dimensão	Preço
F161-0	Ø16x6 mm	€ 4,50
F162-0	Ø21x8 mm	€ 6,60
F163-0	Ø25x10 mm	€ 5,70
F164-0	Ø27x10 mm	€ 6,00

del'air

PRESSOSTATOS



MONOFÁSICO 12 BAR
BLOCO DE 4 VIAS

41090051 € 22

TRIFÁSICO 12 BAR
BLOCO DE 4 VIAS

41090121 € 25

TRIFÁSICO COM TÉRMICO
DE PROTEÇÃO BLOCO DE 4 VIAS



ET 24V 4/6,3AMP
ET 24V 6/10AMP
ET 24V 10/16AMP
ET 24V 13/18AMP

€ 95

del'air

PÁS DE PROJECTAR REBOCO PAREDE

NC 223 P4 - 4 ORIFÍCIOS DE SAÍDA
INDICADO PARA REBOCAR PAREDES
GRANDE VELOCIDADE DE REBOCO
CONSUMO MÍNIMO 350 L/MIN
INOX

€ 246

PÁS DE PROJECTAR REBOCO TECTO

NC 228 S4 - 4 ORIFÍCIOS DE SAÍDA
INDICADO PARA REBOCAR TECTOS
GRANDE VELOCIDADE DE REBOCO
CONSUMO MÍNIMO 350 L/MIN
INOX

€ 246



COMPRESSOR TRANSMISSÃO POR CORREIAS

DELAIR AIRSIL2

4 HP

NB4/4T 400 V

N4AT601 € 2.290

DELAIR AIRSIL2

5.5 HP

NB5/5.5FT 400 V

N5AT701 € 2.700

DELAIR AIRSIL3

10 HP

NB10/10FT 400V

N1AT901 € 3.100



Painel de controlo de fácil leitura. Versões com estrela triângulo têm aviso electrónico de falhas.



Equipado com porta frontal para facilitar a manutenção. Nível de óleo facilmente visível e a recarga é simples graças ao posicionamento da cabeça.



Cabeça potente que assegura um enorme desempenho e uma elevada fiabilidade.

del'air

SILENCIOSO COM DEPÓSITO

DELAIR AIRSIL2

4 HP - 400 V - 270 LT

NB4/4FT/270

SOLUÇÃO INTEGRADA

N4NT601

€ 2.580

DELAIR AIRSIL2

5.5 HP - 400 V - 270 LT

NB5/5.5FT/270

N5NT701

€ 2.780

DELAIR AIRSIL2

7.5 HP - 400 V - 270 LT

NB7/7.5FT/270

N7NT801

€ 3.080



FMD

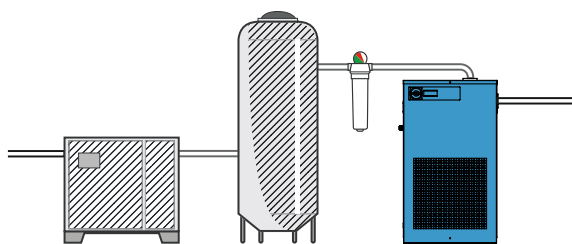

- € 950 FMD 6 - 600 L/min :: 36 m³/H :: 1/2" BSP-F :: 230 V :: 360X480X520:: SCFM 21
- € 1.010 FMD 9 - 950 L/min :: 57 m³/H :: 1/2" BSP-F :: 230 V :: 360X480X520 :: SCFM 34
- € 1.099 FMD 12 - 1200 L/min :: 72 m³/H :: 1/2" BSP-F :: 230 V :: 360X480X520 :: SCFM 42
- € 1.208 FMD 18 - 1800 L/min :: 108 m³/H :: 1/2" BSP-F :: 230 V :: 360X480X520 :: SCFM 64
- € 1.405 FMD 25 - 2500 L/min :: 150 m³/H :: 1" BSP-F :: 230 V :: 345X450X755 :: SCFM 88
- € 1.780 FMD 32 - 3200 L/min :: 192 m³/H :: 1 1/4" BSP-F :: 230 V :: 345X450X755 :: SCFM 113
- € 2.170 FMD 43 - 4300 L/min :: 258 m³/H :: 1 1/4" BSP-F :: 230 V :: 345X450X755 :: SCFM 152
- € 2.410 FMD 52 - 5200 L/min :: 312 m³/H :: 1 1/4" BSP-F :: 230 V :: 475X740X790 :: SCFM 184
- € 2.780 FMD 61 - 6100 L/min :: 366 m³/H :: 1 1/2" BSP-F :: 230 V :: 475X740X790 :: SCFM 216

GÁS AMIGO DO AMBIENTE
R513A

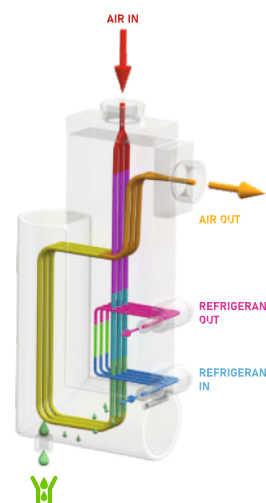

INDUSTRY
Ready 4.0



ACT Dryer Series

FRIULAIR
Dryers

ACT 5 - GÁS R134.a :: 550 L/min :: 21 m³/H :: 1/2" BSP-F :: 230 V :: 345X420X740 :: SCFM 12

€ 1.008

ACT 8 - GÁS R134.a :: 850 L/min :: 51 m³/H :: 1/2" BSP-F :: 230 V :: 345X420X740 :: SCFM 19

€ 1.290

ACT 12 - GÁS R134.a :: 1200 L/min :: 72 m³/H :: 1/2" BSP-F :: 230 V :: 345X420X740 :: SCFM 42

€ 1.470

ACT 18 - GÁS R134.a :: 1800 L/min :: 108 m³/H :: 1" BSP-F :: 230 V :: 345X420X740 :: SCFM 64

€ 1.640

ACT 23 - GÁS R134.a :: 2300 L/min :: 138 m³/H :: 1" BSP-F :: 230 V :: 345X420X740 :: SCFM 81

€ 1.850

ACT 30 - GÁS R407C :: 3100 L/min :: 138 m³/H :: 1 1/4" BSP-F :: 230 V :: 485X455X825 :: SCFM 109

€ 2.400

ACT 40 - GÁS R407C :: 4000 L/min :: 138 m³/H :: 1 1/4" BSP-F :: 230 V :: 485X455X825 :: SCFM 141

€ 2.590

ACT 55 - GÁS R407C :: 5500 L/min :: 330 m³/H :: 1. 1/2" BSP-F :: 230 V :: 555X580X885 :: SCFM 194

€ 2.870

ACT 60 - GÁS R407C :: 6200 L/min :: 372 m³/H :: 1. 1/2" BSP-F :: 230 V :: 555X580X885 :: SCFM 219

€ 3.160

ACT 80 - GÁS R407C :: 8100 L/min :: 486 m³/H :: 2" BSP-F :: 230 V :: 555X625X975 :: SCFM 286

€ 4.680

FRIULAIR
Dryers

SCFM - STANDARD CUBIC FEET PER MINUTE

Pés cúbicos padrão por minuto (SCFM) é a taxa de fluxo de um gás ou ar através de um compressor em condições padrão de temperatura e pressão.

A temperatura padrão para calcular a vazão do SCFM varia de 60°F a 68°F, a uma pressão de 14,7psi e umidade relativa de 36%. Como o SCFM mede o fluxo de ar volumétrico em condições padrão, ele é sempre superior que o valor CFM para um compressor de ar.



DEPÓSITOS VERTICAIS DEL'AIR



del'air
COMPRESSORES



INCLUI MANÓMETRO E
VÁLVULA NÃO AFERIDOS



87NY000054 - DEPÓSITO AR COMPRIMIDO 270 LTS - 11 bar

€ 558

87XY100054 - DEPÓSITO AR COMPRIMIDO 270 LTS 15 BAR

€ 810

S 500 - DEPÓSITO AR COMPRIMIDO 500 LTS - 11 bar

€ 906

S 720 - DEPÓSITO AR COMPRIMIDO 720 LTS - 11 bar

€ 1.200

S 1000 - DEPÓSITO AR COMPRIMIDO 900 LTS - 11 bar

€ 1.430

S 2000 - DEPÓSITO AR COMPRIMIDO 2000 LT - 11 bar

€ 3.510

MANÓMETRO E VÁLVULA NÃO AFERIDOS

FRIULAIR
Dryers

PURGA MECÂNICA 1/2



SCG20

€ 82

PURGA AUTOMÁTICA 1/2



ENTRADA - 1/2
SAÍDA - Ø 6 - 230 V

90990
2012215SCE001

€ 140

PURGA AUTOMÁTICA 3/4



ENTRADA - 3/4
SAÍDA - Ø 6 - 230 V

2215SCE005N

€ 230



ACESSÓRIOS PARA AR COMPRIMIDO



19900000010 - VÁLVULA CERTIFICADA
10 BAR

€ 295

19900000040 - VÁLVULA CERTIFICADA
14 BAR

€ 295



10101322210 - MANÓMETRO CERTIFICADO 10 BAR

€ 145

10101322214 - MANÓMETRO CERTIFICADO 14 BAR

€ 145

VALIDADE CERTIFICAÇÃO 1 ANO | OUTRAS VÁLVULAS E MANÓMETROS AFERIDOS C/ PREÇO SOB CONSULTA



PRÉ-FILTROS SEPARADORES DE ÓLEO SERIES
LFS DE 1 MICRON E LFX DE 0.01 MICRON PARA
LINHAS DE AR COM COMPRESSORES DE PARAFUSO



LFS006 - 1 MICRON - 1/2"
550 L/MIN

€ 110

LFX006 - 0.01 MICRON - 1/2"
550 L/MIN

€ 110

LFS012 - 1 MICRON - 3/4"
1200 L/MIN

€ 114

LFX012 - 0.01 MICRON - 3/4"
1200 L/MIN

€ 114

LFS018 - 1 MICRON - 3/4"
1800 L/MIN

€ 122

LFX018 - 0.01 MICRON - 3/4"
1800 L/MIN

€ 122

LFS023 - 1 MICRON - 3/4"
2300 L/MIN

€ 125

LFX023 - 0.01 MICRON - 3/4"
2300 L/MIN

€ 125

LFS039 - 1 MICRON - 1"
3900 L/MIN

€ 145

LFX039 - 0.01 MICRON - 1"
3900 L/MIN

€ 140

LFS045 - 1 MICRON - 1 1/4"
4500 L/MIN

€ 182

LFX045 - 0.01 MICRON - 1 1/4"
4500 L/MIN

€ 182

LFS061 - 1 MICRON - 1 1/4"
6100 L/MIN

€ 210

LFX061 - 0.01 MICRON - 1 1/4"
6100 L/MIN

€ 210



ACESSÓRIOS PARA LINHAS DE AR

FILTROS SEPARADORES DE ÁGUA E ÓLEO



FRIULAIR Dryers	COMPRESSOR DE PARAFUSO		COMPRESSOR DE PISTON	
	ÓLEO	ÓLEO SINTÉTICO	ÓLEO	ÓLEO SINTÉTICO
WOSS 24	2.4	1.9	1.7	1.4
WOSS 49	4.9	3.8	3.4	2.8
WOSS 73	7.3	5.6	5.1	4.2

WOSS 24

€ 520

FILTRO PARA WOSS24

2235FTL024 € 175

WOSS 49

€ 880

FILTRO PARA WOSS49

WOSS 73

€ 1.590

2235FTL049 € 260

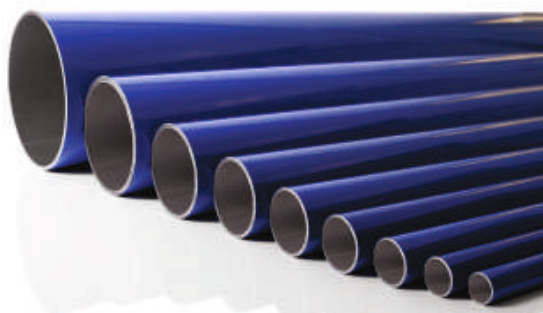

CORES DISPONÍVEIS:



TUBOS PARA CONDUTAS DE AR COMPRIMIDO

ALUMÍNIO CALBRADO CÓD: 90000

MAX 16 BAR - ALUMÍNIO - VARAS 4 METROS

Ø20	€ 33,03	Ø40	€ 64,81
Ø25	€ 40,05	Ø50	€ 106,13
Ø32	€ 51,81	Ø63	€ 127,19

CÓD: 90006

MAX 16 BAR - ALUMÍNIO - VARAS 6 METROS

Ø20	€ 49,56	Ø40	€ 95,50
Ø25	€ 62,31	Ø50	€ 145,94
Ø32	€ 74,49	Ø63	€ 187,38

Dilatações e contrações térmicas

Para calcular a dilatação - contração linear utilizamos a seguinte fórmula:

$$\Delta L = \Delta T \times L \times a \quad \text{onde:}$$

ΔL = Dilatação - contração linear em mm

ΔT = Variação de temperatura entre a temperatura de trabalho e a de instalação em °C

L = Comprimento do tubo em m

a = Coeficiente de dilatação térmica linear que para o alumínio é 0.024 mm/m °C

A instalação deve ser feita de modo que nas extremidades se considere um espaço de permita a dilatação-contração, e os suportes devem ser posicionados como mostra a figura:





Ø20	Ø25	JOELHO 90° 90130
€ 12,51	€ 18,27	
Ø32	Ø40	
€ 29,50	€ 40,50	

Ø20	Ø25	JOELHO 45° 90140
€ 13,41	€ 18,36	
Ø32	Ø40	
€ 27,67	€ 41,61	

Ø20	Ø25	TÊ 90230
€ 17,94	€ 26,10	
Ø32	Ø40	
€ 40,07	€ 57	

Ø20	Ø25	UNIÃO 90040
€ 12,13	€ 16,62	
Ø32	Ø40	
€ 25,51	€ 38,10	

Ø32 - Ø20	Ø40 - Ø20	PICAGEM PARA BAIXADA 90240
€ 37,81	€ 45,51	
Ø40 - Ø25	Ø50 - Ø25	
€ 47,03	€ 57,26	

Ø20 - 1/2	REPARTIDOR COM VÁLVULA 90664
€ 54,49	
Ø25 - 1/2	
€ 70,64	

Ø20	Ø25	VÁLVULA 90700
€ 33,03	€ 46,85	
Ø32	Ø40	
€ 67,89	€ 99,66	

Ø20 - 1/2	Ø25 - 3/4	BAIXADA COM PATER 90600
€ 12,57	€ 15,38	
Ø32 - 1"		
€ 22,92		

Ø20 - 1/2	Ø20 - 3/4	Ø25 - 1/2	Ø25 - 3/4	UNIÃO DE TRANSIÇÃO 90010
€ 7,93	€ 9,39	€ 10,49	€ 10,49	
Ø32 - 1"	Ø40 - 1'	Ø40 - 1'1/4	Ø40 - 1'1/2	
€ 16,39	€ 23,79	€ 23,79	€ 31,02	



Ø20 - Ø20	Ø25 - Ø20	Ø32 - Ø20	Ø32 - Ø25	TÊ DE BAIXADA 90235
€ 20,49	€ 27,20	€ 36,58	€ 37,81	
Ø40 - 20	Ø40 - 25			
€ 52,43	€ 53,78			



ACESSÓRIOS PARA PNEUMÁTICA



FILTRO REGULADOR DE PRESSÃO

1 - 3/8 € 29,19



FILTRO REGULADOR DE PRESSÃO

2 - 1/2 € 31,28



FILTRO REGULADOR DE PRESSÃO

3 - 3/8 € 29,95

4 - 1/2 € 32,04

INFLATOR DUPLO 300 COM PEGA



MOD. T1 € 8,5

INFLATOR DUPLO



MOT. T2 € 5,9

PISTOLA SILICONE



28 G € 23,78

APLIQUE DIRETO

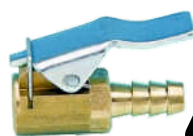

Ø 8
27D
€ 2,23

PISTOLA DE AR



27B
€ 5,29

PISTOLA DE AR



27A € 4,21



AG € 37,58

6-8 bar
250 - 300 l/min

PISTOLA DECAPAR



Ø 6
28 HSS € 34,85

AERÓGRAFO Ø 0.2/0.3



MOD. A1 € 169



27AV
€ 5,44



28E1 € 20,27

6-8 bar
250 - 300 l/min



27C € 8,66



28H
€ 17,33

6-8 bar
250 - 300 l/min

MANGUEIRA



B5 5 € 10



28BA € 14,67

PISTOLA LAVAGEM

PIPO PARA ÁGUA



26 D € 5,35

PISTOLA REGULÁVEL

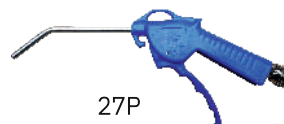

27P
€ 5,9

WJET € 33,71

CONJUNTO PISTOLA E MANGUEIRA



PISTOLA LAVAGEM
28A
€ 12,11



PISTOLA LAVAGEM
28B
€ 12,66



27 A TRUCK
€ 21,18



ACESSÓRIOS PARA PNEUMÁTICA



ENGATE UNIVERSAL
FÊMEA



15A2U	1/4 M	€ 4,22
	3/8 M	€ 4,22
	1/2 M	€ 4,69

ENGATE UNIVERSAL
MACHO



13AM	1/8 M	€ 0,78
	1/4 M	€ 0,80
	3/8 M	€ 1,23
	1/2 M	€ 1,64

ENGATE UNIVERSAL
FÊMEA



142U	6 MM	€ 4,53
	8 MM	€ 4,53
	10 MM	€ 4,69
	12 MM	€ 4,88

ENGATE UNIVERSAL
FÊMEA



14A2U	6X14	€ 5,17
	6X15	€ 5,72
	8X15	€ 5,33
	8X17	€ 5,33
	10X17	€ 6,53
	10X19	€ 6,84

ENGATE UNIVERSAL
FÊMEA



15C2U	1/8 M	€ 4,49
	1/4 M	€ 4,49
	3/8 M	€ 4,49
	1/2 M	€ 5,70

ENGATE UNIVERSAL
MACHO



13AF	1/8 M	€ 0,81
	1/4 M	€ 0,84
	3/8 M	€ 1,23
	1/2 M	€ 1,73

ENGATE DE APERTO



18A	1/8 M	€ 3,95
	1/4 M	€ 4,12
	3/8 M	€ 4,12
	1/2 M	€ 4,78

ENGATE MACHO MACHO



MOD. 12	6	€ 0,71
	8	€ 0,71
	10	€ 0,78
	12	€ 0,84

ENGATE FEMÊA



38F3U	4X6	€ 3,9
	6X8	€ 3,99
	8X10	€ 3,99
	10X12	€ 4,2

TUBO NYLON DIREITO
B8



B8	Ø6-8	€ 53
	Ø8-10	€ 68
	Ø10-12	€ 83

TUBO PA12 POLIAMIDA FLEXIVEL
ROLOS DE 25 OU 100 METROS



	25 METROS	100 METROS
Ø6-8	€ 28	€ 90
Ø8-10	€ 35	€ 116
Ø10-12	€ 42	€ 132





SUPER PROFISSIONAL

MANOMETRO CE Ø80
0-12 BAR

27GSP RIF.2

€ 37,78



PROFISSIONAL

MANOMETRO Ø63
0-12 BAR

27G

€ 13,11

SUPER PROFISSIONAL

MANOMETRO Ø63

27G1

€ 24,58



MANOMETRO Ø80
0-12 BAR
CERTIFICADA CE

27G CE

€ 21



28 C

DISPONÍVEL COM BICO
DE 1.2 MM OU 1.4 MM

28C12
28C14

€ 24,22



28DS

DISPONÍVEL COM BICO
1.4 MM

28DS14

€ 44,44

THE FIRST



COPO SUPERIOR
1.4 MM SUPER PRO
400-500 LT/MIN

THEFIRSTTS14

€ 100,22



COPO INFERIOR
1.4 MM SUPER PRO
400-500 LT/MIN

THEFIRST14

€ 127,56



ACESSÓRIOS PARA PNEUMÁTICA



NOVO MODELO
MAIS FÁCIL DE LIMPAR
COM MICRÓMETRO E REGULDAOR
PARA UMA PINTURA PERFEITA
MINIMIZA O DESPERDÍCIO
MANÓMETRO PARA CONTROLO
IMEDIATO DA PRESSÃO UTILIZADA



INFINITY HVLP € 162,22



REGULADOR DE PRESSÃO

0-12 BAR Ø40
1/4

04POS2

€ 12,56



REGULADOR

- R 1/4 € 21,88
- R 3/8 € 41,86
- R 1/2 € 112,18
- R 3/4 € 112,18
- R 1' € 112,18



FILTRO AR

- FM 1/4 € 24,66
- FM 3/8 € 36,15
- FM 1/2 € 88,13
- FM 3/4 € 88,13
- FM 1' € 88,13



FILTRO AR + DEPURADOR

FDM1/4

€ 85

FDM3/8

€ 100

FDM1/2

€ 100



LUBRIFICADOR AR

- LM 1/4 € 26,07
- LM 3/8 € 41,48
- LM 1/2 € 113,40
- LM 3/4 € 113,40
- LM 1' € 113,40



FILTRO REGULADOR AR

- FRM 1/4 € 43,76
- FRM 3/8 € 57,46
- FRM 1/2 € 189,13
- FRM 3/4 € 189,13
- FRM 1' € 189,13



GRUPO FILTRO + LUBRIFICADOR

FRL2M1/4

€ 70,93

FRL2M3/8

€ 102,75

FRL2M1/2

€ 102,75



GRUPO FILTRO + REGULADOR E LUBRIFICADOR

- FRL3M1/4 € 76,11
- FRL3M3/8 € 114,17
- FRL3M1/2 € 114,17
- FRL3M3/4 € 313,64
- FRL3M1' € 313,64



SECADOR DE AR LINHA S

S3/8 € 102

S1/2 € 298



DEPURADOR AR

DM 1/4 € 77,78

DM 3/8 € 92,22

DM 1/2 € 92,22

DM 3/4 € 95



MR63 - 1/4

€ 9,10



MP40 - 1/8
MP50 - 1/4

€ 7,2



ACESSÓRIOS PARA PNEUMÁTICA



1/4 € 1,62
3/8 € 2,83
1/2 € 6,05



1/4 € 1,62
3/8 € 2,83
1/2 € 6,05



1/4 € 1,62
3/8 € 2,83
1/2 € 6,05



1/4 € 3,16
3/8 € 4,99
1/2 € 10,72



1/4 € 2,53
3/8 € 3,96
1/2 € 7,93



1/4 € 2,53
3/8 € 3,96
1/2 € 7,93



1/4 € 1,30
3/8 € 1,36
1/2 € 1,67



1/4 € 1,81
3/8 € 2,83
1/2 € 7,26



1/4 € 1,81
3/8 € 2,83
1/2 € 7,26



M1/4-F1/4 € 0,64
M1/4-F3/8 € 0,82
M1/4-F1/2 € 1,45
M3/8-F3/8 € 0,91
M3/8-F1/2 € 1,51
M1/2-F1/2 € 1,54
M1/2-F3/4 € 2,88
M3/4-F3/4 € 2,79



1/4 € 3,16
3/8 € 4,99
1/2 € 10,72



1/4 € 3,16
3/8 € 4,99
1/2 € 10,72



1/4 € 2,53
3/8 € 3,96
1/2 € 7,93



1/4-1/8 € 0,52
3/8-1/8 € 0,81
3/8-1/4 € 0,82
1/2-1/8 € 1,29
1/2-1/4 € 1,29
1/2-3/8 € 1,30
3/4-1/4 € 2,31
3/4-3/8 € 2,18
3/4-1/2 € 1,95
1'-3/8 € 5,36



1/4 € 1,07
3/8 € 1,23

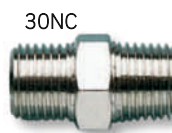

1/4-1/4 € 0,68
3/8-3/8 € 0,93
1/2-1/2 € 1,29
1/4-3/8 € 0,93
1/4-1/2 € 1,32
3/8-1/2 € 1,35
1/2-3/4 € 2,50
3/4-3/4 € 2,77



1/4 € 2,53
3/8 € 3,96
1/2 € 7,93



1/4 € 2,53
3/8 € 3,96
1/2 € 7,93



1/4 € 2,53
3/8 € 3,96
1/2 € 7,93



ACESSÓRIOS PARA PNEUMÁTICA



1/4-1/4 € 0,62

3/8-3/8 € 0,86

1/2-1/2 € 1,24

1/8-1/4 € 0,66

1/8-3/8 € 0,70

1/8-1/2 € 1,16

1/4-3/8 € 0,79

1/4-1/2 € 1,20

3/8-1/2 € 1,85

1/2-3/4 € 4,94

3/4-3/4 € 6,17

1'-1' € 6,79

Ø6 € 2,10

Ø8 € 2,15

Ø10 € 2,20

Ø12 € 2,30

1/4 € 1,52

3/8 € 2,17

1/2 € 2,76

Ø8-6 € 1,10

Ø10-8 € 1,25

Ø12-10 € 1,50

Ø6 € 0,88

Ø8 € 0,94

Ø10 € 1,25

Ø12 € 1,35

12A

6X14 € 1,46

6X15 € 1,46

7X16 € 1,50

8X15 € 1,52

8X17 € 1,52

10X17 € 1,70

10X19 € 1,79



30M

1/4-1/4 € 0,59

3/8-3/8 € 0,96

1/2-1/2 € 1,52

1/4-3/8 € 0,98

1/4-1/2 € 1,74

3/8-1/2 € 1,81

1/2-3/4 € 3,34

3/4-3/4 € 3,10

1/8 - Ø6 € 1,15

1/4 - Ø6 € 1,50

3/8 - Ø6 € 1,65

1/8 - Ø8 € 1,25

1/4 - Ø8 € 1,60

3/8 - Ø8 € 1,90

1/2 - Ø8 € 2,00

1/8 - Ø10 € 1,75

1/4 - Ø10 € 1,80

3/8 - Ø10 € 2,10

1/2 - Ø10 € 2,15

1/2 - Ø12 € 2,90

M5 - Ø6 € 1,19

1/8 - Ø6 € 1,00

1/4 - Ø6 € 1,10

3/8 - Ø6 € 1,45

1/8 - Ø8 € 1,45

1/4 - Ø8 € 1,25

3/8 - Ø8 € 1,55

1/2 - Ø8 € 2,35

1/8 - Ø10 € 1,65

1/4 - Ø10 € 1,90

3/8 - Ø10 € 1,95

1/2 - Ø10 € 2,90

1/8" Ø6 € 0,47

1/4" Ø6 € 0,80

3/8" Ø8 € 0,94

1/2" Ø10 € 1,37

3/4" Ø16 € 4,20

1" Ø25 € 6,17



AP3



AP6

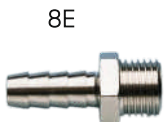

8E

TAMPÃO 1/4 € 0,45
3/8 € 0,65
1/2 € 1,23
30 T 1/8 € 0,39

R7 1/4 € 5,71
3/8 € 5,71
1/2 € 6,46
3/4 € 3,70

18B 1/4 € 4,79
3/8 € 4,79
1/2 € 5,45

R8 1/4 € 5,71
3/8 € 5,71
1/2 € 6,46
3/4 € 3,70

M5 - Ø6 € 1,48
1/4 - Ø6 € 0,85
3/8 - Ø6 € 1,20
1/4 - Ø8 € 1,00

3/8 - Ø8 € 1,25
1/2 - Ø8 € 2,10
AP1 1/4 - Ø10 € 1,35
3/8 - Ø10 € 1,55

1/2 - Ø10 € 2,60
3/8 - Ø12 € 2,10
1/2 - Ø12 € 2,60

AP16 Ø6 € 1,20
Ø8 € 1,20
Ø10 € 1,45
Ø12 € 1,70

AP15 Ø6 € 1,00
Ø8 € 1,10
Ø10 € 1,20
Ø12 € 1,30

VR F3/8 - M3/8 € 5,30
F1/2 - M1/2 € 6,50
M1/2 - M1/2 € 6,50
F1/2 - M3/8 € 5,30

F3/4 - M3/4 € 14,50



ACESSÓRIOS PARA PNEUMÁTICA



AP11



Dimensão	Preço
M5 - Ø6	€ 2,45
1/4 - Ø6	€ 2,01
3/8 - Ø6	€ 2,80
1/4 - Ø8	€ 2,15
3/8 - Ø8	€ 2,10
1/2 - Ø8	€ 3,28
1/4 - Ø10	€ 2,15
3/8 - Ø10	€ 2,20
1/2 - Ø10	€ 3,85
3/8 - Ø12	€ 4,75
1/2 - Ø12	€ 4,40

AP10



Dimensão	Preço
M5 - Ø6	€ 2,05
1/4 - Ø6	€ 1,85
3/8 - Ø6	€ 2,30
1/4 - Ø8	€ 1,90
3/8 - Ø8	€ 2,40
1/2 - Ø8	€ 2,50
1/4 - Ø10	€ 2,00
3/8 - Ø10	€ 2,50
1/2 - Ø10	€ 2,55
3/8 - Ø12	€ 2,60
1/2 - Ø12	€ 2,75

AP9



Dimensão	Preço
M5 - Ø6	€ 1,20
1/4 - Ø6	€ 1,80
3/8 - Ø6	€ 2,10
1/4 - Ø8	€ 1,90
3/8 - Ø8	€ 2,10
1/2 - Ø8	€ 2,98
1/4 - Ø10	€ 2,15
3/8 - Ø10	€ 2,20
1/2 - Ø10	€ 3,76
3/8 - Ø12	€ 2,65
1/2 - Ø12	€ 3,92

AP18



Dimensão	Preço
Ø6	€ 1,15
Ø8	€ 1,15
Ø10	€ 1,45
Ø12	€ 1,80

AP20



Dimensão	Preço
Ø6	€ 2,10
Ø8	€ 2,00
Ø10	€ 2,50
Ø12	€ 3,00

AP6-F



Dimensão	Preço
M5 - Ø6	€ 1,65
1/4 - Ø6	€ 1,89
3/8 - Ø6	€ 1,85
1/4 - Ø8	€ 1,75
3/8 - Ø8	€ 1,85
1/2 - Ø8	€ 2,10
1/4 - Ø10	€ 1,85
3/8 - Ø10	€ 2,00
1/2 - Ø10	€ 2,15

KIT PINTURA BEERGMAN
EM CAIXA DE CARTÃO AA500K

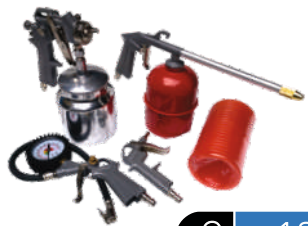

€ 18

PISTOLA DE PINTURA
COM COMPRESSOR 220V ES1



€ 26,5

PISTOLA DE PINTURA
COPO SUPERIOR WF108AL



€ 16

PISTOLA DE PINTURA
COPO INFERIOR 1 LT 4001S



€ 20



TUBOS PARA INDÚSTRIA

COMPOSTO DE BORRACHA SBR / EPDM,
RESISTENTE À ABRASÃO E ÀS INTEMPÉRIES

BITUBO PARA OXIGÉNIO E GÁS

6+6

€ 2,91

8+8

€ 3,45

PREÇO POR METRO

WELTWIN 20



MEDIDA INTERIOR		MEDIDA EXTERIOR		PESO	WP		BP		ROLOS
mm	inch	mm	inch	kg/m	bar	psi	bar	psi	m
6+6	1/4 +1/4	13	1/2	0.35	20	300	60	900	50/100
8+8	5/16 +5/16	15	19/32	0.40	20	300	60	900	50/100



TUBO DE SUÇÃO E DISTRIBUIÇÃO PARA ÁGUA QUENTE,
LÍQUIDOS REFRIGERANTES. MUITO FLEXÍVEL

TUBO PARA RADIADORES

0220304A0N4 - 22X30

€ 16,5

0250334A0N4 - 25X33

€ 16,5

CALORFLEX SD/5

0280364A0N4 - 28X36

€ 18

PREÇO POR METRO



MEDIDA INTERIOR		PESO	WP		BP		RATO DE DOBRA	VACUO	ROLOS
mm	inch	kg/m	bar	psi	bar	psi	mm	bar	m
15	19/32	0.42	5	75	15	225	55	0.8	40
16	5/8	0.45	5	75	15	225	60	0.8	40
18	45/64	0.48	5	75	15	225	65	0.8	40
19	3/4	0.50	5	75	15	225	70	0.8	40
20	25/32	0.52	5	75	15	225	70	0.8	40
22	7/8	0.54	5	75	15	225	75	0.8	40
25	1	0.58	5	75	15	225	85	0.8	40
28	1 7/64	0.64	5	75	15	225	95	0.8	40
30	1 3/16	0.68	5	75	15	225	100	0.8	40
32	1 1/4	0.73	5	75	15	225	105	0.8	40
35	1 3/8	0.82	5	75	15	225	115	0.8	40
38	1 1/2	0.93	5	75	15	225	130	0.8	40
40	1 37/64	1.00	5	75	15	225	135	0.8	40
42	1 21/32	1.05	5	75	15	225	140	0.8	40
45	1 25/32	1.18	5	75	15	225	150	0.8	40
50	1 31/32	1.30	5	75	15	225	165	0.8	40
55	2 11/64	1.50	5	75	15	225	180	0.8	40
60	2 23/64	1.70	5	75	15	225	200	0.8	40
63.5	2 1/2	1.74	5	75	15	225	210	0.8	40
70	2 3/4	2.00	5	75	15	225	220	0.8	40
76	3	2.17	5	75	15	225	250	0.8	40
80	3 5/32	2.25	5	75	15	225	270	0.8	40
90	3 35/64	2.57	5	75	15	225	300	0.8	40
102	4	3.17	5	75	15	225	340	0.8	40

OUTROS DIÂMETROS E PRESSÕES ESTÃO DISPONÍVEIS MEDIANTE PEDIDO.
DADOS TÉCNICOS, ESTRUTURAIS E POLÍMEROS PODEM SER ALTERADOS SEM AVISO PRÉVIO.



TUBOS PARA INDÚSTRIA



TUBOS PARA TRANSPORTE, ENTREGA E RECOLHA DE LÍQUIDOS E SÓLIDOS, RESISTENTES À ABRASÃO E INTEMPÉRIES. LISOS E CORRUGADOS.

TUBOS PARA ÁGUA
BORRACHA SBR
PARA FLUÍDOS INERTES
NÃO CORROSIVOS



TUBOS PARA ÁGUA
BORRACHA EPDM
LONGAS DISTÂNCIAS
ÁGUAS E DETERGENTES



TUBOS PARA PROPANO
BORRACHA NBR
LINHAS GPL, INDÚSTRIA
E SOLDADURA



TUBOS PARA CERVEJA
BORRACHA NBR
VINHO, ÁLCOOL, ALIMENTAR
REFRIGERANTES



TUBOS PARA VAPOR
BORRACHA EPM
PARA RADIORES,
REFRIGERAÇÃO...



TUBOS PARA ÁGUA
BORRACHA EPDM
INDÚSTRIA DO VIDRO
NÃO CONDUTORA



TUBOS PARA AREIA
ANTIESTÁTICO CBR/NR/PVC
PARA DECAPAGENS A
AREIA E GRANALHA



TUBOS PARA GASES
BORRACHA EPDM
EXTRACÇÃO DE GASES
OFICINAS, INDUSTRIA, ETC



TUBOS PARA ÁGUA
BORRACHA EPDM
LONGAS DISTÂNCIAS
ÁGUAS E DETERGENTES



TUBOS PARA AR COMP
BORRACHA SBR/EPDM
AR COMP. E FLUÍDOS IN.
REFORÇO DE FIO DE AÇO



TUBOS SUÇÃO
CORRUGADO CR
PEDRAS, ROCHAS, AREIA
MINAS, TUNEIS, CONSTRUÇÃO



TUBOS BETÃO E GESSO
QUATRO CAMADAS SBR/NR
GESSO, BETÃO, PARA
CAMIÕES BOMBA ETC..



TUBO PARA ACETILENO
WELRED 20 L/L BORRACHA 20 BAR MAX

DIMENSÃO €/MT
8x15 € 1,52 GL20A2



ID		OD		WEIGHT	WP		BP		COIL LENGTH
mm	inch	mm	inch	kg/m	bar	psi	bar	psi	m
6	1/4	13	1/2	0,16	20	300	60	900	50/100
8	5/16	15	19/32	0,18	20	300	60	900	50/100
9	23/64	16	5/8	0,20	20	300	60	900	50/100
10	3/8	17	43/64	0,21	20	300	60	900	50/100
13	1/2	23	29/32	0,40	20	300	60	900	50/100
16	5/8	26	15/16	0,53	20	300	60	900	50/100
19	3/4	30	13/16	0,62	20	300	60	900	50/100
25	1	37	129/64	0,86	20	300	60	900	50/100

TUBO DE BORRACHA PARA AR COMPRIMIDO
AERGEN 20 L/L BORRACHA 20 BAR MAX

DIMENSÃO €/MT

6x14 € 1,48 15x25 € 2,54

8x17 € 1,77 16x26 € 2,75

10x19 € 1,80 19x30 € 3,45

13x23 € 2,72 25x32 € 5,30

€/MT

TUBO DE BORRACHA PARA OXIGÉNIO
WELBLU 20 L/L BORRACHA 20 BAR MAX

DIMENSÃO

6x13 € 1,15 13x23 € 3,38

8x15 € 1,73 16x26 € 3,92

9x16 € 1,72 19x30 € 5,08

10x17 € 1,86 25x37 € 7,34



AL20A0



GL20A3





MECÂNICA E ELEVAÇÃO



ZAVAGLI



CAPACIDADE - 3500 KG
 MOTOR - 3 KW - 4 HP
 380 V - 50/60 HZ
 TEMPO DE SUBIDA m/S - 0.033
 TEMPO DESCIDA m/S - 0.033
 PORCAS DE SEGURANÇA EM MATERIAL
 AUTOLUBRIFICANTE
 BRAÇO COM TRINCO DE ROTAÇÃO AUTOMÁTICO
 PROTEÇÃO DE PÉS
 2480 MM ENTRE COLUNAS

Z51 / 3S
 ELECTROMECAÂNICO COM BASE

€ 4.050



Z4 OPCIONAL

€ 465

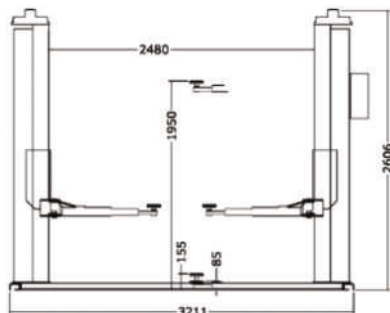
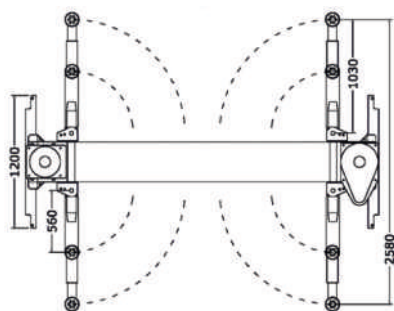

ZAVAGLI



Z52 / 3S
 ELECTROMECAÂNICO SEM BASE

CAPACIDADE - 3500 KG
 2 MOTORES - 1.1 KW + 1.1 KW
 380 V - 50/60 HZ
 TEMPO DE SUBIDA m/S - 0.033
 TEMPO DESCIDA m/S - 0.033
 PORCAS DE SEGURANÇA EM MATERIAL
 AUTOLUBRIFICADNTE
 PROTEÇÃO DE PÉS
 2480 MM ENTRE COLUNAS
 BRAÇO COM TRINCO DE ROTAÇÃO
 AUTOMÁTICO

€ 4.960

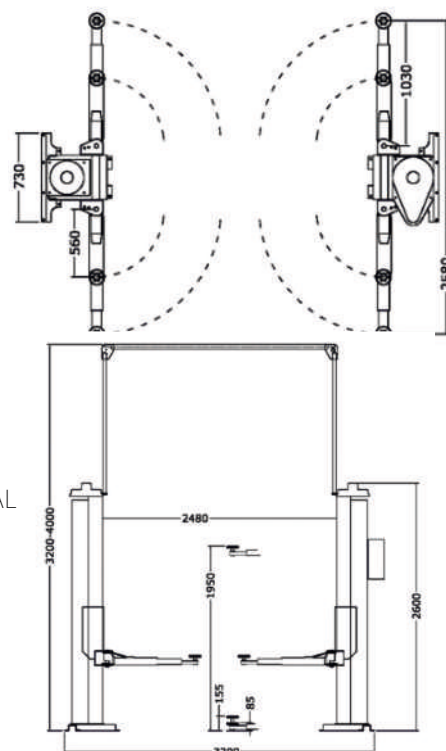

ELEVADORES ELECTRO-MECÂNICOS

CAPACIDADE - 3500 KG

MOTOR - 3 KW - 4 HP

380 V - 50/60 HZ

TEMPO DE SUBIDA m/S - 0.033

TEMPO DESCIDA m/S - 0.033

PORCAS DE SEGURANÇA EM MATERIAL

AUTOLUBRIFICANTE

PROTEÇÃO DE PÉS

2650 MM ENTRE COLUNAS

BRAÇO COM TRINCO DE ROTAÇÃO

AUTOMÁTICO

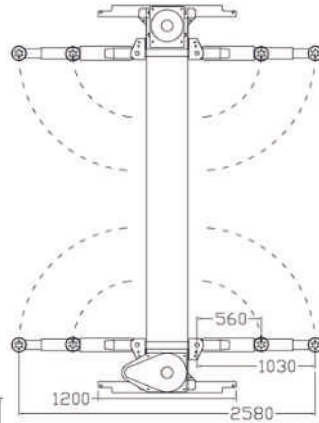

Z51 / 3SL
ELECTROMECHANICO COM BASE

€ 4.690

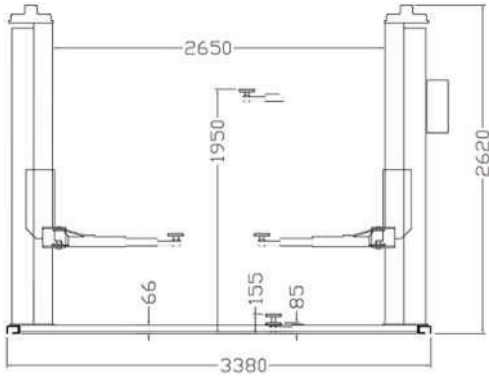

ZAVAGLI

Z61 / 3S
ELECTRO HIDRÁULICO C/ 2 CILINDROS E BASE



CAPACIDADE - 3500 KG

MOTOR - 1.5 kw

380 V - 50/60 HZ

TEMPO DE SUBIDA m/S - 0.033

TEMPO DESCIDA m/S - 0.033

PORCAS DE SEGURANÇA EM MATERIAL

AUTOLUBRIFICADNTE

PROTEÇÃO DE PÉS

2480 MM ENTRE COLUNAS

BRAÇO COM TRINCO DE ROTAÇÃO

AUTOMÁTICO

€ 4.580

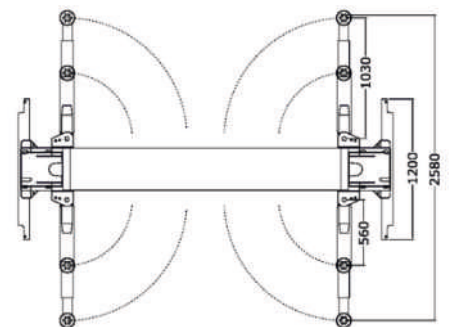
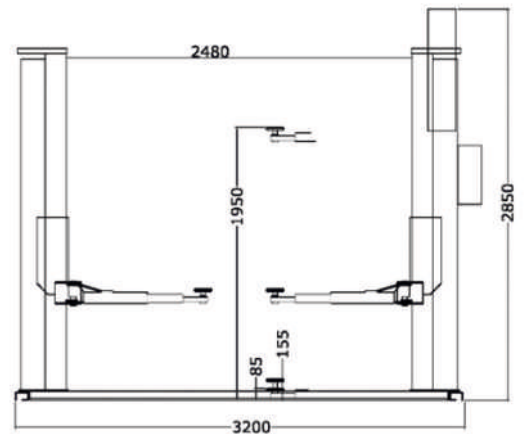

ZAVAGLI



Z63 / 3S
ELECTRO HIDRAULICO C/ 2 CILINDROS
SEM BASE

CAPACIDADE - 3500 KG
MOTOR - 1.5 KW
380 V - 50/60 HZ
TEMPO DE SUBIDA m/S - 0.033
TEMPO DESCIDA m/S - 0.033
PROTEÇÃO DE PÉS
2480 MM ENTRE COLUNAS
BRAÇO COM TRINCO DE ROTAÇÃO
AUTOMÁTICO

€ 4.800

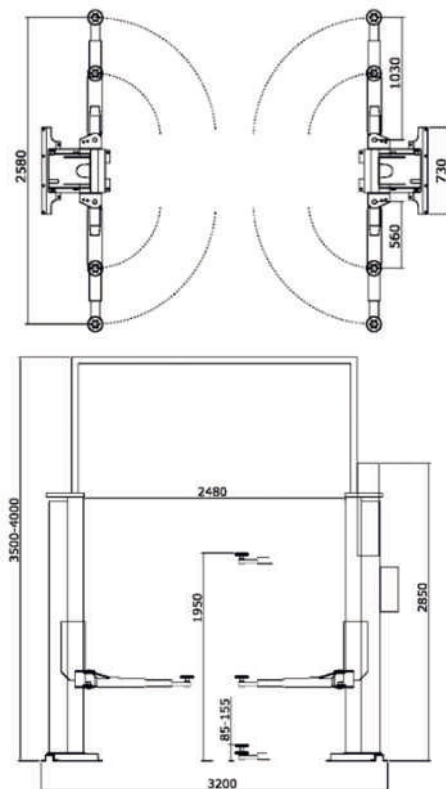

Königstein



DISPONÍVEL: MONOFÁSICO
E TRIFÁSICO

3.0 KW
KN3245PSX PRO
4.5 TON

€ 4.050

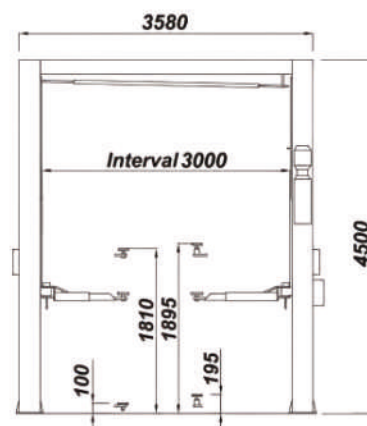
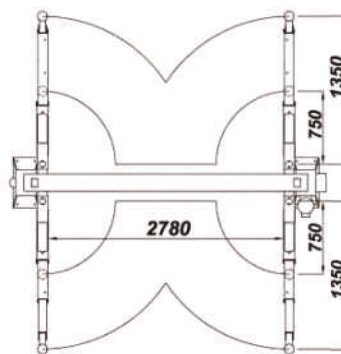

COLUNAS EM AÇO DE
5 MM DE ESPESSURA
CABO SINCRONIZADOR DE 12 MM
QUADRO COM 2 DIF. DE SEGURANÇA
TEMPO DE SUBIDA/DESCIDA < 50 S
ALTURA 4500 MM
BRAÇOS 580-1140 MM
BRAÇOS 900-1430 MM
PESO 720 KG
3 METROS ENTRE COLUNAS
LIMITADOR DE SUBIDA



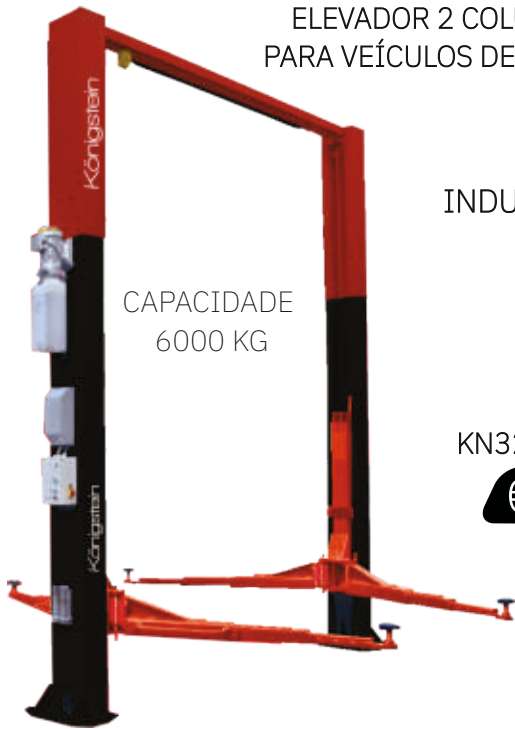

ELEVADOR 2 COLUNAS
PARA VEÍCULOS DE CARGA

INDUSTRIAL

CAPACIDADE
6000 KG

KN3260PSX

€ 6.760

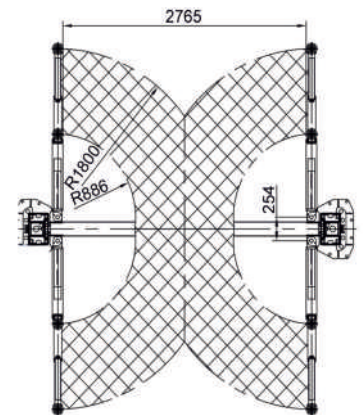
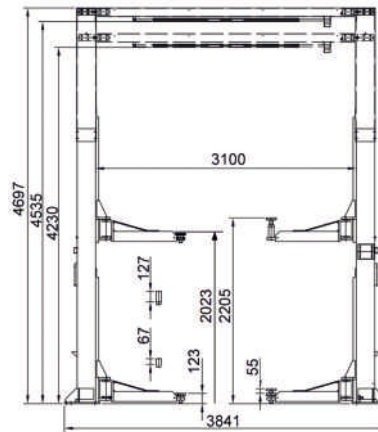

ELEVADOR AJUSTÁVEL EM ALTURA
SEGURANÇAS ELECTROMAGNÉTICAS
BRAÇOS EXTENSÍVEIS EM 3 PEÇAS
BARRA SUPERIOR DE FIM DE CURSO
TACOS DE 67 MM E 127 MM INCLUÍDOS
ALTURA MÍNIMA - 123 MM
TEMPO DE ELEVAÇÃO - 50 S
PESO - 1100 KG

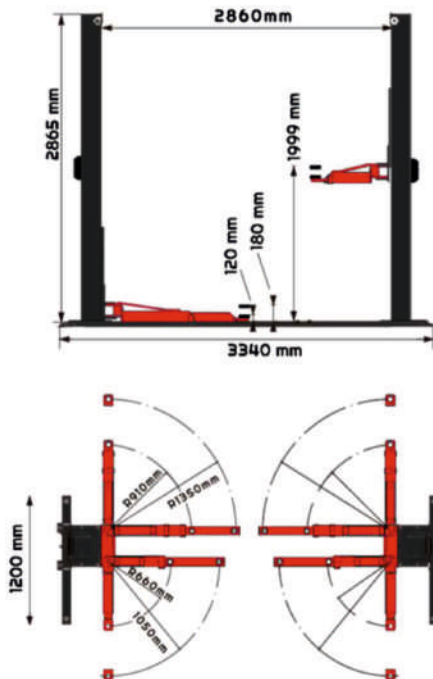

Königstein

MONOFÁSICO
KN3245AB PRO

€ 3.930

TRIFÁSICO
KN3245AB PRO

€ 3.890



ELEVADOR 2 COLUNAS
ELECTROHIDRÁULICO
COM BASE H 4.5 TON

BRAÇOS ESTICAM 1350 MM
2860 MM UTIL INTERNO

SOBE ATÉ 1835 MM
CAPACIDADE 4.500 KG
ALTURA - 2865 MM
LARGURA 3340 MM
MOTOR 2.2 KW
COLUNAS EM CHAPA DE 5 MM
GRANDE DISTANCIA ENTRE COLUNAS

OPCIONAIS:
BRAÇOS ARTICULADOS

€ 940

BRAÇO DE PERFIL BAIXO
85 MM

€ 550



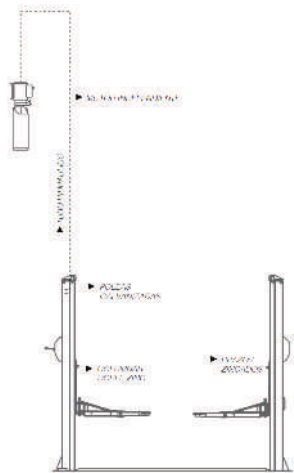

ESPECIAL PARA LAVAGENS

ELEVADOR HIDRÁULICO DE 2 COLUNAS
CAPACIDADE - 4000 KG
PESO 650 KG
PAINEL DE CONTROLO
CORRENTE DE FUNCIONAMENTO: 380V OU 220V

KN3240WL WATERLIFT

€ 5.350

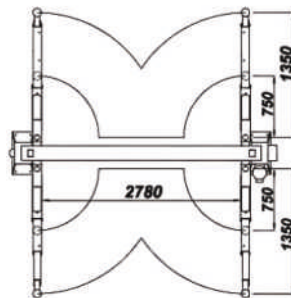
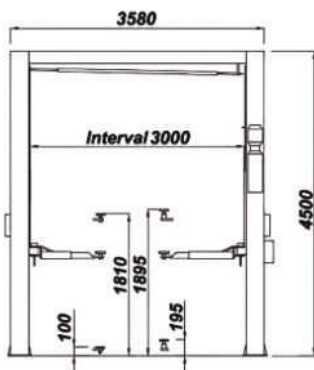

NEW



CAPACIDADE - 4500 KG
ALTURA MINIMA - 195 MM
ALTURA MÁXIMA - 4500 MM
LARGURA 3580 MM
COLUNAS EM FERRO 5MM
PESO 700 KG

ESPECIAL CARROS ELÉTRICOS

KN3245PSX PRO EV

€ 5.450



ELEVADORES ELECTROHIDRÁULICOS



ELEVADOR DE TESOURA
ELECTROHIDRÁULICO PARA ALINHAMENTO

VERSÃO DE
ENCASTRAR

VERSÃO 4.2 TON



KN3642DT € 14.990

CAPACIDADE - 4200 KG
TEMPO DE ELEVAÇÃO - 60 S
COMP. DA PLATAFORMA 4845 MM
PERFIL MÍNIMO 75 MM
POTÊNCIA 2.2 kW
COMPRIMENTO 5.5 MTS
ESPAÇO PARA PLACAS DE ALINHAMENTO
SINCRONIZAÇÃO E NIVELAMENTO ELÉCTRICO
SISTEMA DE SEGURANÇA MECÂNICO
TRANCAS PNEUMÁTICAS

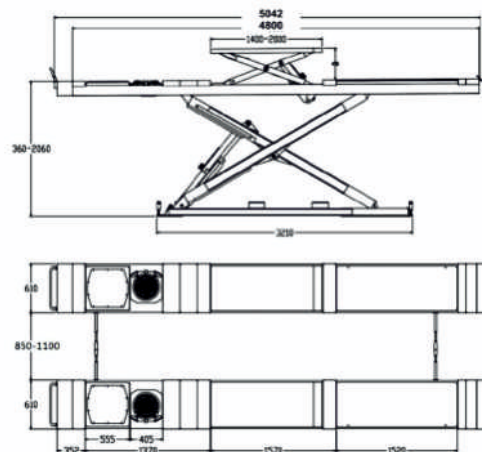

RAMPAS OPCIONAIS PARA
INSTALAÇÃO À SUPERFÍCIE

KN-R10

€ 1.500



ELEVADOR DE TESOURA
KN3645 DTS

VERSÃO SUPERFÍCIE

€ 15.700



CAPACIDADE - 4500 KG
IDEAL PARA VEÍCULOS COMPRIDOS
SUBIDA ATÉ 2080 MM
ALTURA MÍNIMA - 240 MM



RAMPAS EXTENSÍVEIS PARA
VEÍCULOS COMPRIDOS
MOTOR 3 KW - 400V

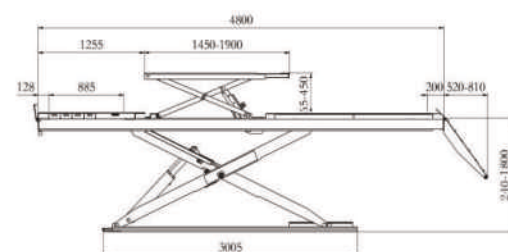
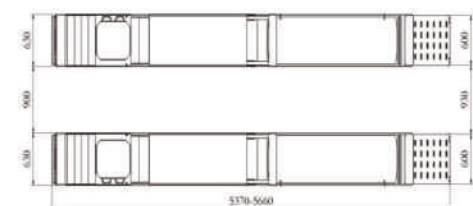

ELEVADOR DE TESOURA
KN3655DT PRO

VERSÃO 5.5 TON

KN-R11- RAMPAS

€ 17.990

ELECTROHIDRÁULICO
PARA ALINHAMENTO

€ 1.500



CAPACIDADE - 5500 KG
IDEAL PARA VEÍCULOS COMPRIDOS
SUBIDA ATÉ 1950 MM
RAMPAS EXTENSÍVEIS PARA
VEÍCULOS COMPRIDOS
MOTOR 3 KW - 400V

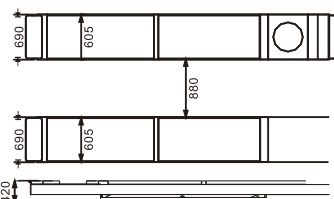
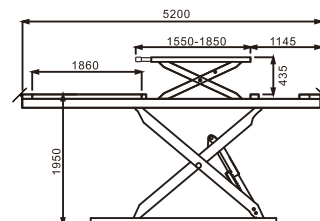

KN3655DTX PRO +
DETETOR DE FOLGAS € 20.900



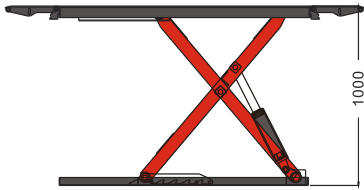

ELEVADOR TESOURA

CAPACIDADE - 3000 KG
SUBIDA ATÉ 1000 MM
MONOFÁSICO - 230V
MOTOR 2.2 KW
ALTURA MÍNIMA DO SOLO 110 MM
DESBLOQUEIO PNEUMÁTICO
FIM DE CURSO

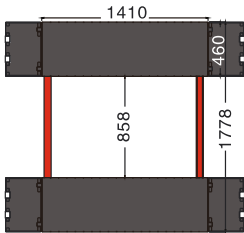

Kn3630 N

€ 2.890



ELEVADOR TESOURA PARA ENCASTRAR

CAPACIDADE - 4000 KG
ALTURA MÁX - 1999 MM
TRIFÁSICO - 400V
MOTOR 3.0 KW
ALTURA MÍNIMA DO SOLO 330 MM
ATÉ 2060 DE COMPRIMENTO

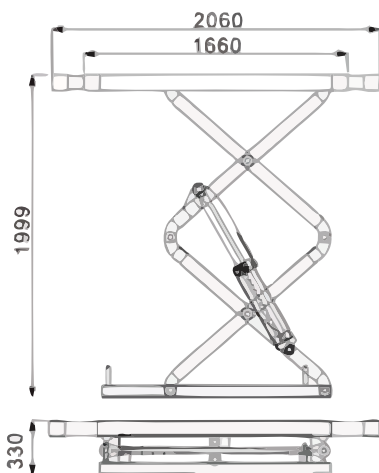

KN3640 E

€ 4.880





ELEVADOR DE TESOURA
ELECTROHIDRÁULICO PARA MOTOS

KN3610MT

€ 2.790



CAPACIDADE - 1000 KG
ALTURA DE ELEVAÇÃO - 1200 MM
PERFIL MÍNIMO 115 MM
TRANCA MECÂNICA
DUPLO CILINDRO
GRAMPO DA RODA ZINCADO
RAMPA MÓVEL

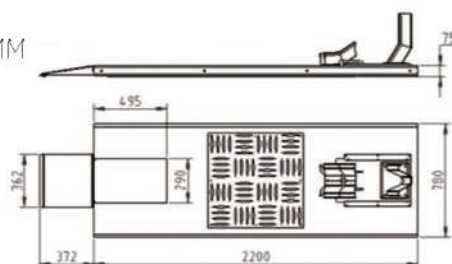
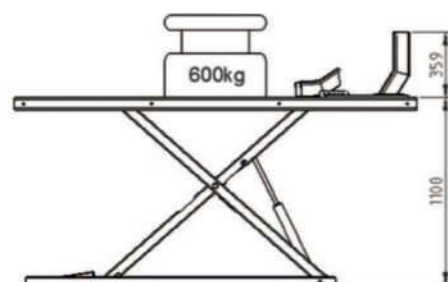

ELEVADOR DE TESOURA
VERSÃO À SUPERFÍCIE
5 TON

KN3650DTS

€ 16.350



RAMPA ARTICULADA INTEGRADA
RAMPAS EXTENSÍVEIS INTEGRADAS
IDEAL PARA VEÍCULOS LONGOS
CAPACIDADE - 5000 KG - 4000 KG (RAMPA)
ALTURA DE ELEVAÇÃO - 1800MM (PLATAFORMAS PRINCIPAIS)
ALTURA MÍNIMA - 240MM
PLATAFORMA - 5300 MM
400/50 V
ILUMINAÇÃO LED INCLUÍDA



ELEVADORES TESOURA

GRANGE TEAM
TERMOMECCANICA GL

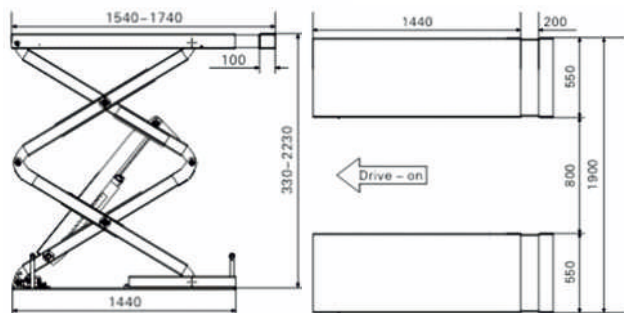

CAPACIDADE - 3500 KG
 ALTURA MÍNIMA - 330 MM
 ALTURA MÁXIMA - 2230 MM
 TEMPO DE SUBIDA - 60 S
 400 V
 AZUL (RAL5015)
 TRAVÃO AUTOMÁTICO EM
 CASO DE FALTA DE PRESSÃO
 DE ENCASTRAR

STD 7335

€ 5.250

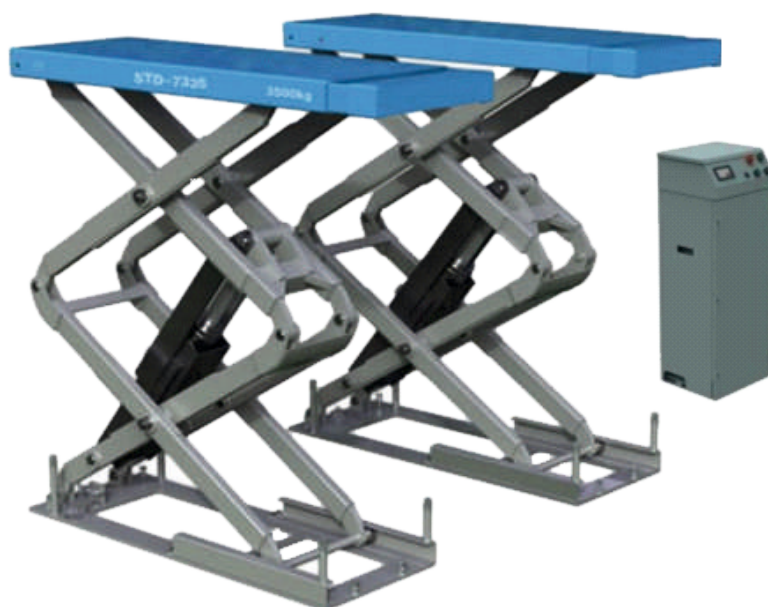

GRANGE TEAM
TERMOMECCANICA GL

ELEVADOR DE TESOURA ELECTRO HIDRÁULICO

4 PISTONS - STD 7230 B

400 V € 5.260

CAPACIDADE - 3000 KG
 TEMPO DE SUBIDA - 60 SEG
 ALTURA DE ELEVAÇÃO - 1900 MM
 PERFIL MÍNIMO 112 MM
 TRANCA MECÂNICA
 DUPLO CILINDRO
 COM ACRESCENTOS NA PLATAFORMA

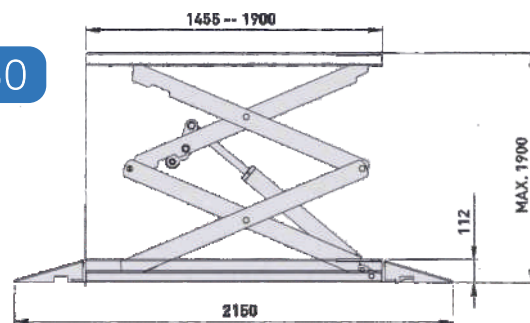

GRANGE TEAM
TERMOMECCANICA GL

ELEVADOR DE ESTEIRA ELECTRO HIDRÁULICO

TESOURA DUPLA - 3000 KG
 KIT DE DESLOCAMENTO
 NÃO NECESSITA DE FIXAÇÃO AO SOLO
 RAMPAS COM FIXAÇÃO PARA BASE

STD 7530

€ 3.990

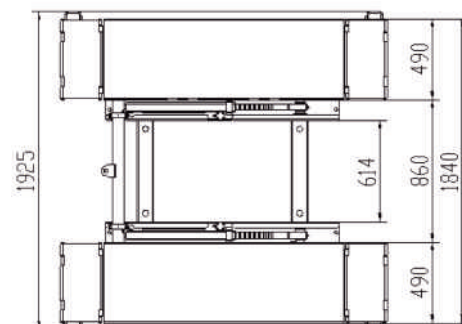
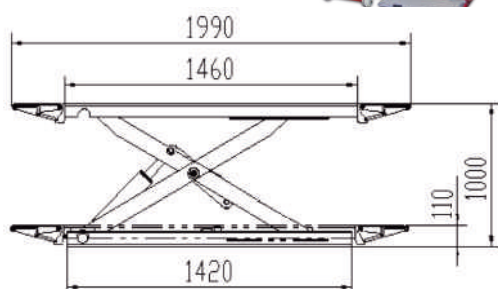



ELEVADOR DE UMA COLUNA

CAPACIDADE - 2500 KG
 ALTURA MÁX - 1825 MM
 TEMPO DE SUBIDA - 40 S
 ALTURA MÍNIMA - 100MM
 POTÊNCIA - 2.2 kW 3 Hp
 PESO - 770 KG
 BRAÇOS AMOVÍVEIS
 BORRACHAS COM REGULAÇÃO
 SEGURANÇA MECÂNICA PARA
 PROTECÇÃO DA HIDRÁULICA
 ROBUSTO PARA UMA VIDA LONGA

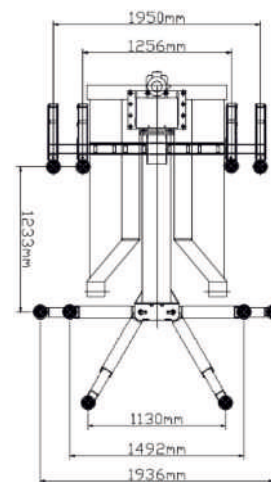

KN3125PA

€ 4.450

ELEVADOR DE 4 COLUNAS ESPECIAL ALINHAMENTO

4 TON
 JOGO DE PRATOS E RODAS TRASEIRAS LIVRES
 2.2 KW - 400V - 1.200 KG
 PLATAFORMA LONGA E LARGA PARA MAIS
 LIBERDADE DE OPERAÇÕES E PARA CARRINHAS
 DE DIMENSÕES MAIORES

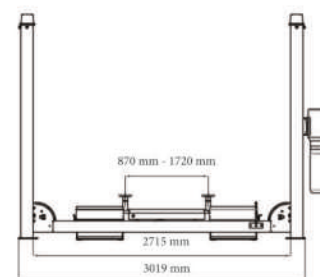
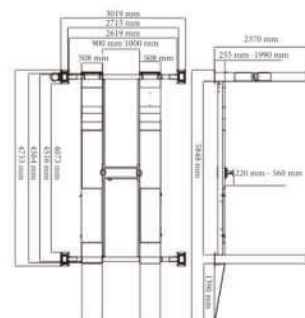
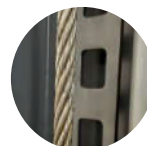

KN3440A
 4.0 TON

€ 5.690

MACACO OPCIONAL



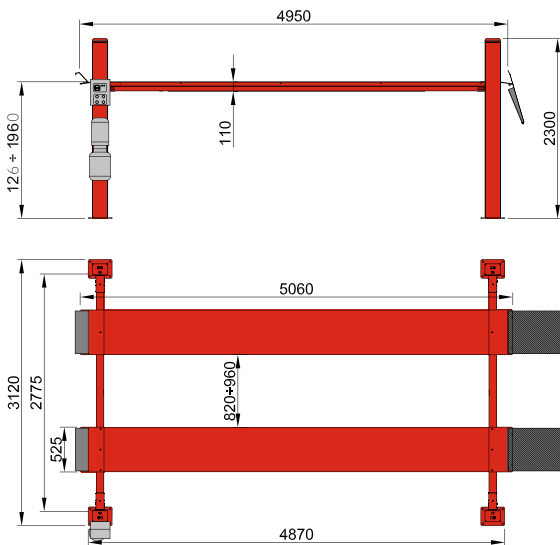

ELEVADOR 4 COLUNAS TECO 4TON

ALTURA MÍNIMA DO CHÃO - 126 MM



TECO 4004 B

€ 6.960

- CAPACIDADE - 4000 KG
- MOTOR - 2.6 KW
- 380 V - 50/60 HZ
- TEMPO DE SUBIDA - 34 S
- TEMPO DESCIDA - 33 S
- TRANCAS DE SEGURANÇA
- 4 BOBINES ELETRO MAGNÉTICAS



ELEVADOR 4 COLUNAS INDEPENDENTES

MCL 55M.4S

- CAPACIDADE - 22 TON - 4X5.5 TON
- MOTOR - 1.6 KW
- SISTEMA DE NIVELAMENTO AUTO-ELÉTRICO
- TEMPO DE SUBIDA m/S - 0.035
- TEMPO DESCIDA m/S - 0.035
- VÁLVULA DE SEGURANÇA
- VÁLVULA DE CONTROLO DE DESCIDA

MCL 75 4S

- CAPACIDADE - 30 TON - 4 x 7.5 TON

MCL 85 4S

- CAPACIDADE - 34 TON - 4 x 8.5 TON

€ 20.800

€ 23.200

€ 24.900



DISPONÍVEL KIT ADAPTADOR PARA RODAS 700-500 / 800-700 / 900-800



LINHA DE INSPECÇÃO AUTOMÓVEL



€ 20.990

PREÇO DO CONJUNTO



BANCO DE TESTE DE TRAVÕES RBT3500 XS

TESTE DE TRAVÕES PARA CARROS, QUADRICICLOS E MOTOCÍCLOS ATÉ 3.5 TON
SOFTWARE DE TESTE PARA WINDOWS
MÁXIMO PESO POR EIXO - 2500 KG
MOTOR POWER: 2 X 4 KW (5,5 KM/H TEST SPEED)
ROLOS REVESTIDOS, SISTEMA DE BALANÇA, SUSPENSÃO E TESTE DERRAPAGEM.
DIMENSÕES - 2330 X 650 X 275 MM

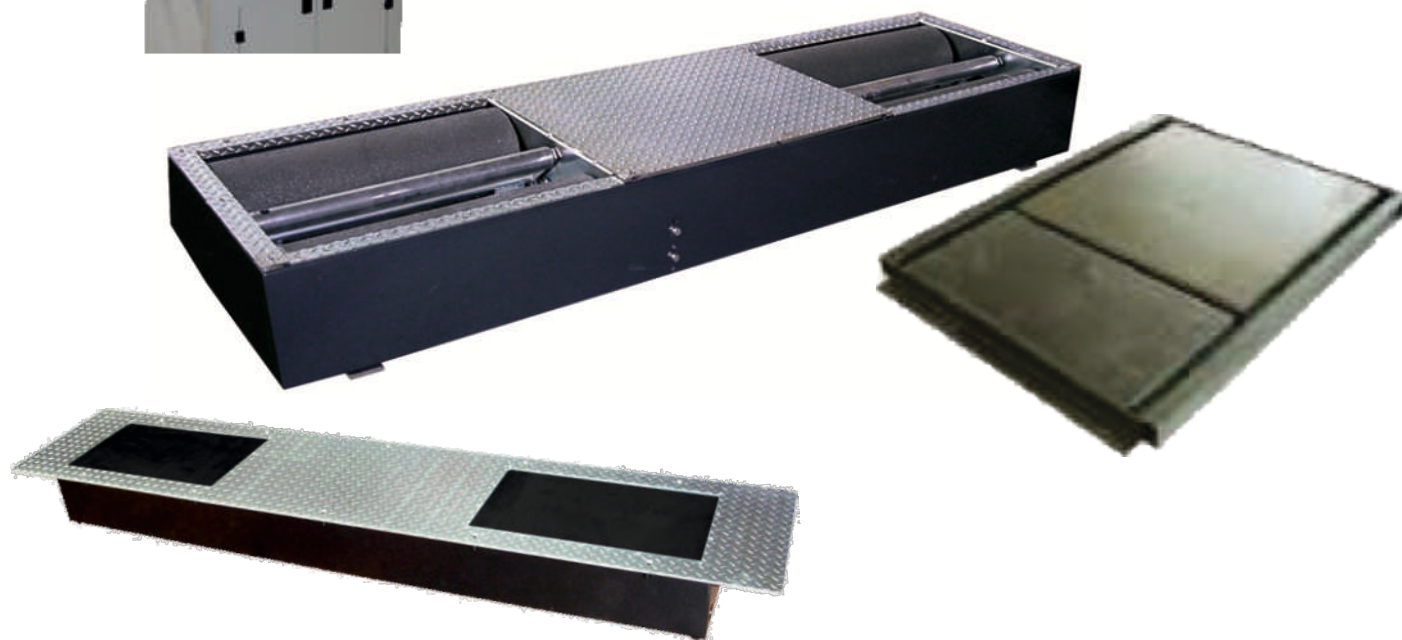

RIPÓMETRO - TRZ

KIT DIR 2/4 WD +STL - KIT ALIMENTACAO CONEXAO PC
PRATO DESLIZANTE GALVANIZADO
VM 02 - CONTROLE REMOTO INFRAVERMELHO
T100/GREY - CONSOLA C/SUORTE LCD
KIT T100 + MULTIFICHAS + PC VMG -
WINDOWS, PC, MONITOR, RATO, TECLADO E IMPRESSORA

TESTE DE SUSPENÇÃO - STL

COM SISTEMA DE CÁLCULO EUSAMA
O SOFTWARE VERIFICA OS PARÂMETROS:
MÓDULO DE TESTE DE SUSPENÇÃO DE VIBRAÇÃO
SISTEMA DE PONDERAÇÃO EMBUTIDO
MEDIÇÃO AUTOMÁTICA DE PESO
MÁXIMO PESO POR EIXO - 2000 KG
DIMENSÕES - 2335 x 650 x 275 MM



MAXI BULL

BANCADA DE ENDIREITAMENTO RÁPIDO



COM RAMPAS
INCLUÍDAS

REPARAR RAPIDAMENTE PEQUENOS E MÉDIOS DANOS.
A FIRMEZA DO CHASSI PERMITE O POSICIONAMENTO DE QUALQUER TIPO DE VEICULO DE FORMA RÁPIDA E SIMPLES SEM O USO DE RAMPAS

POTENCIA DE ELEVAÇÃO - 3000 KG
ALTURA MÍNIMA DO SOLO - 140 MM
ALTURA MÁXIMA DO SOLO - 1312 MM
TEMPO DE SUBIDA - 60 SEGUNDOS
ALIMENTAÇÃO - 230 / 400 V - 50/60 HZ - 3 PH
PESO 1300 KG - 4 TORNOS UNIVERSAIS
BRAÇO DE TRAÇÃO COM ENCAIXE 360°

OPCIONAIS

KIT BMW
KIT MERCEDES
KIT HONDA /A ROVER



€ 16.800

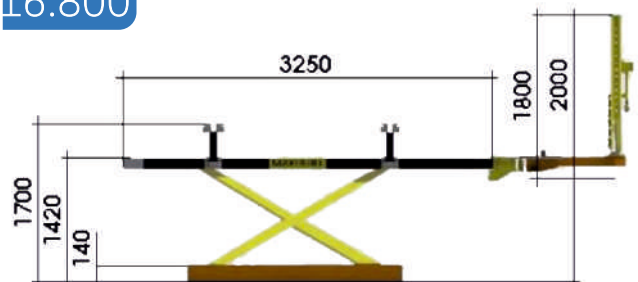

ÁREA DE PREPARAÇÃO

ESTUDADA E PROJECTADA PARA REALIZAR OPERAÇÕES DE POLIMENTO, LIXA E PREPARAÇÃO PARA PINTURA EM AMBIENTE LIMPO LIVRE DE FUMO E POEIRAS.

BASE 6000 X 4000 MM
MOTOR 7.5 HP
COM RAMPAS

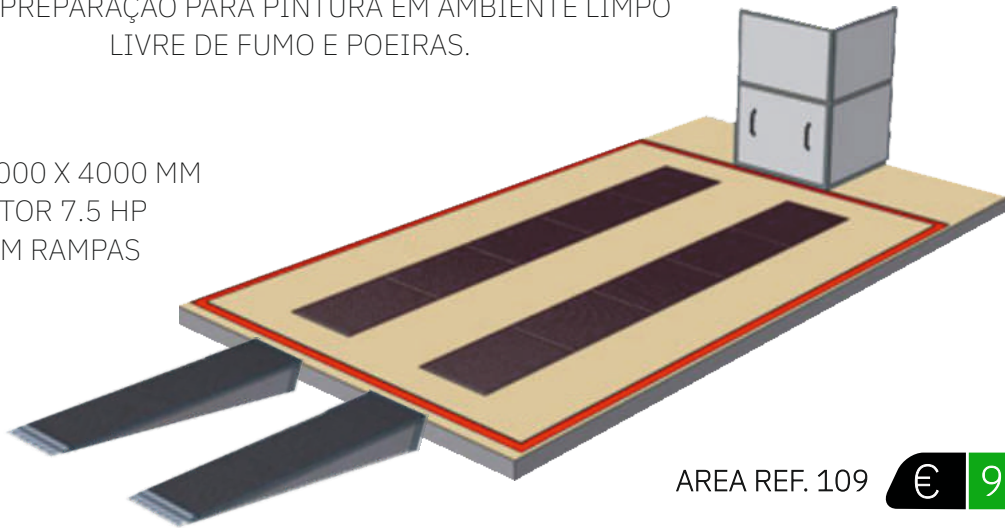

AREA REF. 109

€ 9.900

BOX DE TINTAS

ESTUDADA E PROJECTADA PARA A PREPARAÇÃO DE TINTAS E MISTURAS, MESMO COM O OPERADOR DENTRO DA CABINE. SERVE DE ARMAZÉM DE TINTAS E MISTURADORES. EQUIPADA COM LAMPADA DE TECTO 4 NEON 36 WATT VENTILADOR CENTRIFUGO MOTOR ELECTRICO DE FUNCIONAMENTO DIRETO PAINEL PARA CONTROLO DA CABINE



TINTO BOX
3X2 X 2.5/2.7

€ 4.450

TINTO BOX
4X2 X 2.5/2.7

€ 5.320



NÃO ESTÁ INCLUÍDO OBRA CIVIL, ALIMENTAÇÃO ELÉCTRICA E PNEUMÁTICA, TUBAGENS DE EXAUSTÃO DO QUEIMADOR E DA EXTRAÇÃO

CABINE DE PINTURA - GL1 - TERMOMECCANICA



BRANDE TEAM
TERMOMECCANICA GL

PRODUTO DE QUALIDADE DE TOPO PARA CLIENTES EXIGENTES
COM BASE E RAMPAS - EXTRAÇÃO DE DUAS LINHAS
COMP - 7 MT :: LARGURA - 4 MT :: ALTURA 2.80 MT
FILTRO DE TETO E ILUMINAÇÃO SUPERIOR EM NEONS
CALDEIRA EM AÇO INOX E QUEIMADOR DE GLP
CAUDAL MÁXIMO 18.000 / 20.00 MC / H - MOTOR 10 HP
POTÊNCIA QUEIMADORES - 180.000 KCAL / H

€ 30.900



NÃO ESTÁ INCLUÍDO OBRA CIVIL, ALIMENTAÇÃO ELÉCTRICA E PNEUMÁTICA, TUBAGENS DE EXAUSTÃO DO QUEIMADOR E DA EXTRAÇÃO



CORTINAS DE FILTRO SECO

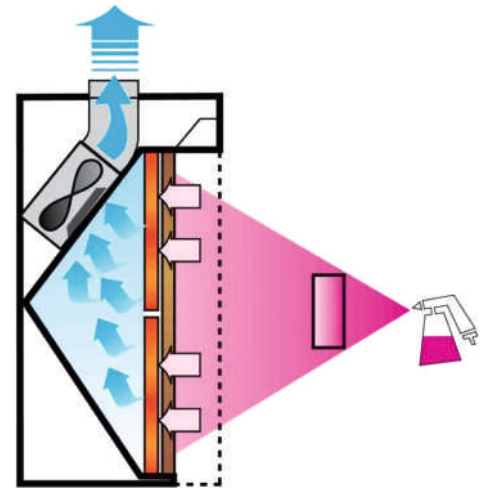
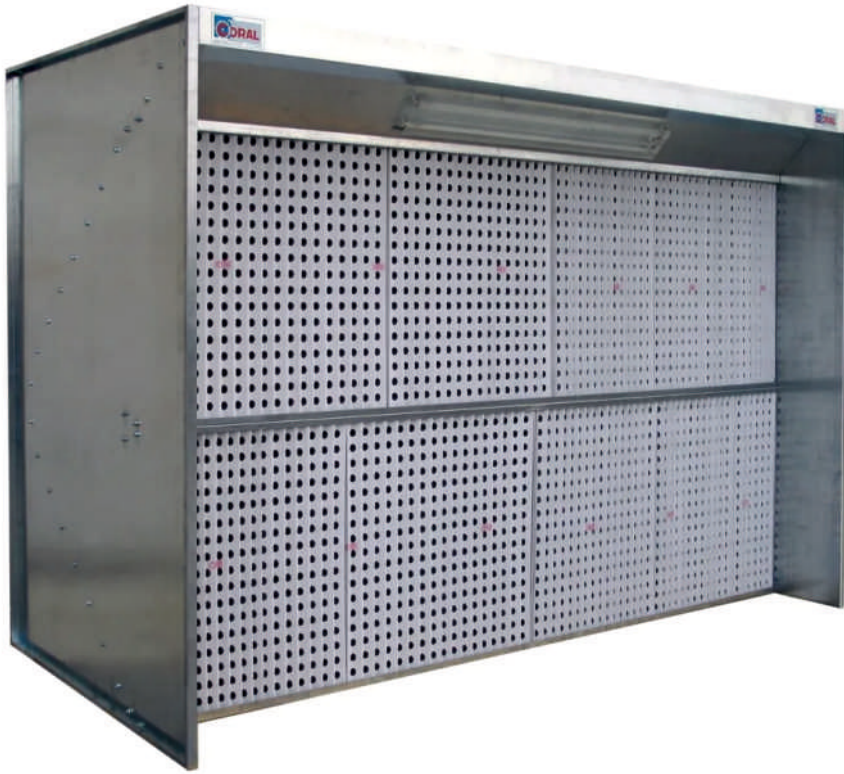

ECONOMIA DE ENERGIA
ASPIRAÇÃO FRONTAL
FILTRO DE PAPEL DE SÉRIE
SEM DISPERSÃO
ASPIRADORES ANTI-FAÍSCA
COM MOTOR 3G/D DE BAIXO RUÍDO

PROJECTADA PARA PINTURA CONTÍNUA, MESMO DE PEÇAS DE GRANDES DIMENSÕES.
EQUIPADA COM VENTILADORES DE ALTO RENDIMENTO EM VERSÃO ANTI-FAÍSCA.
POSSIBILIDADE DE INSTALAÇÃO DE PAREDES E TETOS ALARGADOS
PARA OTIMIZAR A VELOCIDADE DE ASPIRAÇÃO (VERSÃO N/B - PREÇO SOB CONSULTA),



INCLUI QUADRO ELECTRICO E ILUMINAÇÃO TETO



NÃO INCLUI TUBAGEM DE EXAUSTÃO

MODELO	Versão	Ventilador	Potência do Ventilador (HP)	Caudal Máximo (m3/h)	Caudal Máximo (cfm)	Altura (mm)	Largura (mm)
TECNODRY N/A 2 € 4.420	Sucção frontal	1	2	7000	4120	2068	2066
TECNODRY N/A 2.5 € 5.330	Sucção frontal	1	3	10000	5885	2146	2566
TECNODRY N/A 3 € 5.500	Sucção frontal	1	3	10000	5885	2146	3066
TECNODRY N/A 4 € 7.500	Sucção frontal	2	2	14000	8240	2068	4068
TECNODRY N/A 5 € 8.990	Sucção frontal	2	3	20000	11771	2146	5068
TECNODRY N/A 6 € 9.220	Sucção frontal	2	3	20000	11771	2416	6068

Todos os equipamentos têm a profundidade de 1375 mm e a altura útil de 1965mm

FILTROS PARA CABINE DE PINTURA

FILTRO PARA TETO CABINE

FILTRO TECHOM - MANTA FLUTUANTE SINTÉTICO
MICROMALHA AUTOEXTINGUÍVEL
IMPREGNADA 650 GRS - M2 - EFICÁCIA 98%
EUROVEN EU-5 DIN EN779 - M5 - IGNIFUGA

ROLO 20MTS X 2MTS

M5-IGNIFUGA.ROOF

€ 590



FILTROS PARA CHÃO CABINE

ROLO FIBRA VIDRO PAINSTOP 2
AUTO EXTINGUÍVEL
EFICÁCIA 95%
EU 4

ROLO 0,75 X 20MTS

FV 075 PAINTSTOP € 47,50

ROLO 1 X 20MTS

FV 100 PAINTSTOP € 55,50

FILTRO PARA QUEIMADOR

MANTA FILTRANTE EFICÁCIA COARSE 65%
ISO 16890
G4 - EN779 ROLO 20MTS X 2MTS
200 GR/M2 G4200B2000

€ 126



BOMBAS DE PINTURA AIRLESS

TR15000F Airless + KIT A050010*



Bomba de pintura Airless extremamente potente, ideal para grandes superfícies. Perfeito para trabalhos de pintura interior em larga escala, permitindo o uso simultâneo por dois operadores. Adequado também para pintura exterior com tintas de quartzo, aplicação de massas de enchimento e trabalhos de impermeabilização.

€ 4550

TR10000F Airless + KIT A050010*



Bomba de pintura Airless potente e versátil para superfícies médias e grandes. Indicado para trabalhos de pintura em madeira e metal, pintura interior e exterior, aplicação de resinas epóxi em pavimentos, reabilitação e encapsulamento de amianto.

€ 3600

***KIT de Pintura A050010 inclui:** Sistema de aspiração de tinta F36x2 com filtro de aço inoxidável; Conector com manómetro de pressão; Mangueira de alta pressão com malha metálica, diâmetro 1/4", pressão de trabalho de 300 Bar, comprimento de 10 metros; Pistola profissional Airless B500; Extensão de 50 cm para pistola de pintura Airless + Bico autolimpante Paintip.

TR4000P Airless + KIT A040012*



Bomba de pintura Airless prático e fácil de usar para superfícies pequenas e médias. Adequado para pintura de madeira, metal e interiores com tintas superlaváveis.

€ 2150

***KIT de Pintura A040012 inclui:** Depósito de 6 litros; Conector com manómetro de pressão; Mangueira de alta pressão com malha metálica, diâmetro 1/4", pressão de trabalho de 300 Bar, comprimento de 10 metros; Pistola profissional Airless B500; Extensão de 50 cm para pistola de pintura Airless + Bico autolimpante Paintip.

Características técnicas:

Referência	Alimentação	Potência	Pressão Máx.	Caudal	Projeção	Nível Sonoro	Mangueira	Tipo
TR4000P	220V	0,9 kW	220 bar	4 l/min	30 m	61 dB(A)	10 m	Portátil
TR10000F	220V	1,8 kW	230 bar	9 l/min	70 m	75 dB(A)	10 m	Móvel
TR15000F	220V	2,2 kW	250 bar	13 l/min	80 m	75 dB(A)	10 m	Móvel



Vantagens do sistema Airless



O sistema de pintura Airless distingue-se pela sua elevada eficiência e performance superior em relação aos métodos convencionais de pintura. Este sistema não utiliza ar comprimido para pulverizar a tinta, eliminando as turbulências causadas pelo ar. Assim, proporciona uma maior cobertura, com resultados uniformes e de alta qualidade.

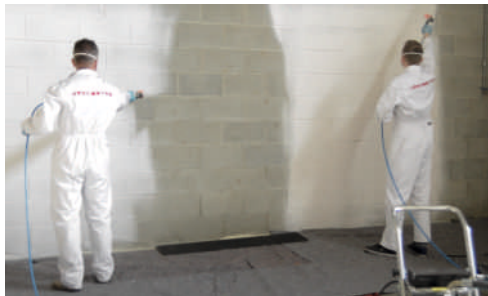

Produtos aplicáveis:	TR15000F	TR10000F	TR4000P
Impermeabilizantes betuminosos	X		
Impermeabilizantes elastoméricos	X		
Impermeabilizantes depoliuretano	X		
Encapsulantes para amianto	X	X	
Tintas acrílicas de siloxano	X		
Tintas de quartzo	X		
Tintas intumescentes para parede	X		
Tintas intumescentes para madeira	X		
Tintas intumescentes para metais	X		
Tintas laváveis	X	X	
Tintas superlaváveis	X	X	X
Tintas têmpera	X	X	
Tintas respiráveis	X	X	
Primários para parede	X	X	X
Primários para madeira	X	X	
Primários para metais	X	X	X
Resinas acrílicas	X		
Resinas epóxi	X		
Resinas de poliuretano	X		
Esmaltes de parede	X	X	X
Esmaltes para madeira	X	X	X
Esmaltes para metais	X	X	X
Estuques	X		



LIMPEZA DE PISTOLAS DE PINTURA



EQUIPAMENTO DE LIMPEZA DE PISTOLAS DE PINTURA



TANQUE DE ÁGUA - 50 LT
PESO - 114 KG
DIMENSÃO - 990 X 690 X 1490
PNEUMÁTICA - 6 A 10 BAR
EXAUSTÃO - 150 MM DIAMETRO

COMBINADA- LAVAGEM DE TINTA À BASE DE ÁGUA E À BASE DE SOLVENTES.
ZONA DE LIMPEZA COM EXAUSTÃO AUTOMÁTICA
LAVAGEM AUTOMÁTICA COM BOMBA DIAFRAGMA DE LIQUIDO RECICLADO.
BOMBA VENTURI E NEBULIZADOR PARA LAVAGEM FINAL COM ÁGUA
KIT DE SEPARAÇÃO DE ÁGUA E TINTA
BOMBA PARA DILUENTE LIMPO.
100% INOX

SL 427

€ 4.690



EQUIPAMENTO DE LIMPEZA DE PISTOLAS DE PINTURA



PARA LAVAGEM MANUAL PARA PINTURA À BASE ÁGUA
BOMBA VENTURI PARA RECICLAGEM LIQUIDO
LAVAGEM FINAL COM PULVERIZADOR UTILIZANDO ÁGUA LIMPA
PISTOLA DE SOPRO PARA A SECAGEM FINAL
KIT DE SEPARAÇÃO ÁGUA-PINTURA INCLUÍDO
100% INOX

SL 16

€ 1.490

TANQUE DE ÁGUA - 50 LT
PESO - 50 KG
DIMENSÃO - 490 X 690 X 1490
PNEUMÁTICA - 6 A 10 BAR



MÁQUINA DE RECICLAR DILUENTE



MÁQUINA LAVAR PEÇAS E LAVAR TRAVÕES
270 V - COM MESA DE APOIO
FAZ A RECICLAGEM DE SOLVENTES UTILIZADOS NA LAVAGEM DE COMPONENTES
CICLO COMPLETAMENTE AUTOMÁTICO
FUNCIONA POR PRESSÃO ATMOSFÉRICA
NO FINAL DO CICLO OS RESÍDUOS FICAM NO SACO
DESTILA ATÉ 15 LITROS
DISPLAY DIGITAL - CICLOS 3/4 HORAS
TEMPERATURA MÁXIMA 200°C - 1KW - 230 V

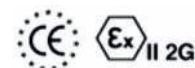

801 A

€ 4.690





DETERGENTE CONCENTRADO

EMBALAGEM
5 LITROS

RE - 5

€ 80

DETERGENTE CONCENTRADO DILUÍVEL EM ÁGUA
NOVA FORMULA COM POUCA ESPUMA

USADO A FRIO:

MELHORA A LAVAGEM MESMO EM TINTA SECA

USADO A QUENTE:

REDUZ PARA METADE O TEMPO DE LAVAGEM E PERMITE

UMA LIMPEZA COMPLETA MESMO EM TINTA SECA

MANTÉM A BOMBA, MANGUEIRA E BICOS SEMPRE LIMPOS

É REUTILIZÁVEL APÓS COAGULAÇÃO

5-15% DE DILUIÇÃO EM ÁGUA



PRENSA 20TON

PRENSA ACIONAMENTO PEDAL

20 TON

MIN - 180 | MAX - 955

LARGURA TRABALHO - 550

WP20H € 560



PRENSA 10TON

PRENSA ACIONAMENTO PEDAL

10 TON

MIN - 180 | MAX - 910

LARGURA TRABALHO - 454

WPR10F € 441



CARRO SUPORTE DE PEÇAS

PARA BATE-CHAPAS E
PINTURA AUTOMÓVEL

53125

€ 350



MACACO DE FOSSA

MACACO DE FOSSAS
500 KGS

05.084.05P

€ 220



protools



protools

100%
MADE IN
ITALY



PJS005.310.1
5.5 TON € 210
MIN: 310 MM - MAX: 480 MM

PJS005.445.1
5.5 TON € 240
MIN: 445 MM - MAX: 730 MM

PTJ010.695.1
10 TON € 462
MIN: 695 MM - MAX: 1200 MM

PJS010.310.1
10 TON € 268
MIN: 310 MM - MAX: 480 MM

PJS010.445.1
10 TON € 325
MIN: 445 MM - MAX: 730 MM

PTJ020.695.1
20 TON € 487
MIN: 695 MM - MAX: 1200 MM

PJS020.310.1
20 TON € 312
MIN: 310 MM - MAX: 480 MM

PJS020.445.1
20 TON € 362
MIN: 445 MM - MAX: 730 MM

protools



PJX020.245.1

CAPACIDADE 10-20 TON
2 PISTONS DESMULTIPLICAÇÃO
6-8 BAR - PESA 25 KG
MAX 538 MM | MIN 250 MM

€ 1.220



PJA030.150.2P

CAPACIDADE 30-15 TON
2 PISTONS DESMULTIPLICAÇÃO
9-12 BAR - PESA 33 KG
MAX 295 MM | MIN 150 MM

€ 1.770

VEICULOS PESADOS



PJA040.150.2L

CAPACIDADE 40-20 TON
2 PISTONS DESMULTIPLICAÇÃO
8-10 BAR - PESA 55 KG
MAX 295 MM | MIN 150 MM

€ 1.990

PJA040.125.3

CAPACIDADE 40-22-10 TON
3 PISTONS DESMULTIPLICAÇÃO
8-10 BAR - PESA 34 KG
MAX 275 MM | MIN 125 MM

€ 2.650

PJA050.200.2

CAPACIDADE 50-30 TON
2 PISTONS DESMULTIPLICAÇÃO
9-12 BAR - PESA 75 KG
MAX 410 MM | MIN 200 MM

€ 2.540



PJA075.180.3S

CAPACIDADE 75-50-25 TON
3 PISTONS DESMULTIPLICAÇÃO
8-10 BAR - PESA 115 KG
MAX 430 MM | MIN 180 MM

€ 3.480



05.084.26

MACACO DUPLO PISTON
5 TON
MIN - 100 MM | MAX - 533 MM
PESO - 44 KG



€ 319

5t

05.084.02L

MACACO DUPLO PISTON
BAIXO PERFIL
3 TON
MIN - 80 MM | MAX - 495 MM
PESO - 37 KG



€ 220

3t

MARCO TOOLS
BY SPIN

SUPORE FRONTAL
PARA MOTORES

900
KG

6 RODAS PARA MAIOR ESTABILIDADE
ALTURA DO SOLO: 800 MM
PRATO DE FIXAÇÃO: 250X150X12 MM
CAPACIDADE 900 KG - 36 KG



05.085.12

€ 247

GRUA
DESMONTÁVEL



05.085.08 COMBI

€ 364

CAPACIDADE: 1 TON
MEDIDAS: 1620X930X1600MM
EMBALAGEM: 800X860X1600MM
76 KG

MARCO TOOLS
BY SPIN

MACACOS DE GARRAFA



KRWBJ2
2 TON € 14

KRWBJ10
10 TON € 40

KRWBJ12
12 TON € 42



	MOD.	ALTURA MÍNIMA	SOBE	FUSO
05.084.16	20 TONS	235	145	60
05.084.15	32 TONS	255	150	--

05.084.16
20 TON € 72

05.084.15
32 TON € 123



MARCO TOOLS
BY SPIN



CILINDRO 19 LITROS
VÁLVULA DE SEGURANÇA
IDEAL PARA TUBELESS ATÉ 24.5"
MANÓMETRO Ø50 MM
DIMENSÕES EMBALAGEM: 46X40X31 - 14 KG

03.000.52 € 135



CARRO DE TRANSPORTE
PARA PNEUS DE PESADOS
AJUSTÁVEL
CAPACIDADE: 250 KG
PARA PNEUS DE 6.5' A 22.5'

05.088.130 € 250



MARCO TOOLS
BY SPIN

IDEAL PARA CARROS ELÉTRICOS



PLATAFORMA ELEVATÓRIA ATÉ 1915 MM

1.200 KG CAPACIDADE

PLATAFORMA DE ELEVAÇÃO ELECTRO-HIDRÁULICA
PROJECTADA PARA MONTAR E DESMONTAR
MOTORES, CAIXAS E BATERIAS DE LÍTIO
DE AUTOMÓVEIS HÍBRIDOS E ELÉCTRICOS.
MÁX 191,5 CM - MIN 56 CM - CAPACIDADE - 1200 KG
DIMENSÃO DA PLATAFORMA - 130 X 77 cm
PESO 418KG



05.085.27 € 4.000





PRENSAS HIDRÁULICAS COM PISTON MÓVEL

PRENSA HIDRÁULICA COM PISTON MÓVEL
VÁLVULA DE SEGURANÇA DE SOBRECARGA
RETORNO AUTOMÁTICO DO CILINDRO
MANÓMETRO DE PRESSÃO
PISTÃO DE AÇO TRATADO
VÁLVULA LIMITADORA



P25M - 25 TON - 1 VELOCIDADE

€ 1.090

P35M - 35 TON - 1 VELOCIDADE

€ 1.210

PD35M - 35 TON - 2 VELOCIDADES

COM ELEVADOR DE MESA

€ 1.499

PD50M - 50 TON - 2 VELOCIDADES

COM ELEVADOR DE MESA

€ 2.460

MARCO TOOLS
by SPIN



DECAPAGEM A AREIA INDUSTRIAL

05.075.16

ABERTURA SUPERIOR
ASPIRADOR COM CICLONE
420 LITROS
COMANDO PEDAL
CICLONE PERMITE UMA EXTRAÇÃO
DO PÓ E DA AREIA EFICAZ
ILUMINAÇÃO INTERNA
INCLUI: 4 CERÂMICAS
1 PISTOLA INDUSTRIAL
2 LAMPADAS HALOGENIO
5 PELICULAS DE PROTEÇÃO DA LUZ
2 ROLOS DE VEDAÇÃO
1 ROLO TEFLON E SEPARADOR DE ÁGUA

€ 1.800

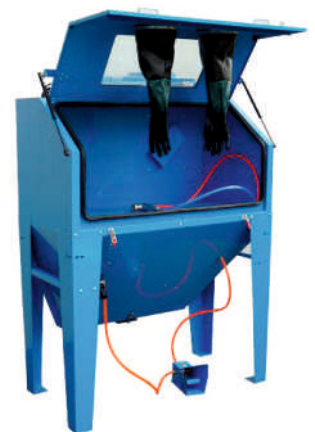

DIMENSÃO EXTERNA - 1210X610X1700 MM
DIMENSÃO BOX - 1200X600X370/600 MM
DIMENSÃO PORTA - 1000X570 MM
BICO 6.7 MM

PRESSÃO DE TRABALHO ENTRE 3.5 E 5.5 BAR
CONSUMO DE AR 630 LT/MIN



DECAPAGEM A AREIA















05.075.10



PRESSÃO DE TRABALHO ENTRE 2.8 E 5.6 BAR
 CONSUMO DE AR - 450/550 LT/MIN
 DIMENSÃO BOX - 596X838X625 MM
 PREPARADO PARA ASPIRAÇÃO (NÃO INCLUÍDA)

INLCUI:
 PAR DE LUVAS
 CONJUNTO DE BICOS
 PISTOLA DE JACTO DE AREIA

€ 510

SPARE PARTS	 Cod. 05.075.16	 Cod. 05.075.10	 Cod. 05.075.17	 Cod. 05.075.18
BOCAIS PARA PISTOLA	 Cod. 05.075.22	 Cod. 05.075.11	 Cod. 05.075.26	 Cod. 05.075.24
PISTOLA DECAPAGE	 Cod. 05.075.23	 Cod. 05.075.13	 Cod. 05.075.28	 Foto indicativa / Indicative picture Cod. 05.075.29
PAR DE LUVAS	 Cod. 05.075.12	 Cod. 05.075.12		

PREÇOS DOS ACESSÓRIOS
 SOB CONSULTA



COMANDOS DE MOTOR

165
KIT

MODELOS DISPONIVEIS



+15
NUOVI
KIT

NOVOS MODELOS INCLUIDOS

FIAT 1.0 BENZINA; EB2 DEL GRUPPO PSA; FORD BENZINA; BMW.
 VASTA GAMMA DEDICATA AI MOTORI BENZINA PORSCHE E VOLKSWAGEN.
 ATTREZZI PER RUOTA FONICA PER MOTORI LAND ROVER/JAGUAR;



STEPLINE 2300 - ESPECIAL MOTAS 220V

HELPER HSA 21 - 8-11900262

€ 450

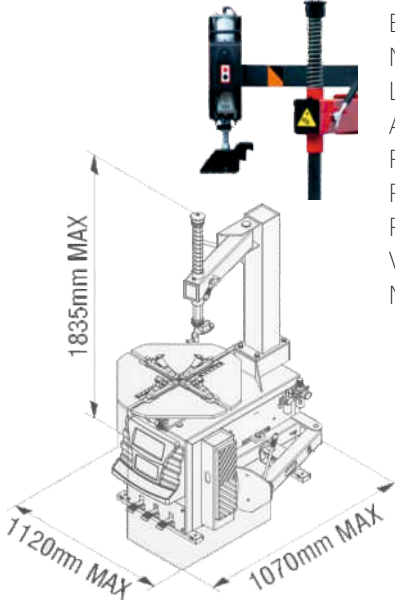

GRAMPO EXTERIOR - 10" - 21"
 BRAÇO INTERNO - 12" - 23"
 MÁX. DIÂMETRO DA RODA - 960 mm
 LARGURA DO PNEU - 3" A 12"
 ABERTURA DE DISJUNTORES - 320 mm
 PODER QUEBRA O ROLAMENTO - 2500 N
 PRESSÃO DO AR DE TRABALHO - 8 - 10 bar
 POTÊNCIA DO MOTOR (PEDAL DUAS VELOCIDADES) - 0,75 kW - 1,1 kW
 VELOCIDADE DE ROTAÇÃO DO CHUCK - 7 rpm
 NÍVEL DE RUÍDO EM EXECUÇÃO: <70 dB

SEMI AUTOMÁTICA
 0-11901512/16 € 1.290

KIT GRAMPOS MOTOBIKE
 C-M-0200000A € 139
 (6-25") 4 pcs



OPÇÃO TRIFÁSICA ACRESCE 130 EUROS



GRAMPO EXTERIOR - 10" - 21"
 BRAÇO INTERNO - 12" - 23"
 MÁX. DIÂMETRO DA RODA - 1040 mm
 LARGURA DO PNEU - 3" A 12"
 ABERTURA DE DISJUNTORES - 320 mm
 PODER QUEBRA O ROLAMENTO - 2800 N
 PRESSÃO DO AR DE TRABALHO - 8 - 10 bar
 POTÊNCIA DO MOTOR (PEDAL DUAS VELOCIDADES) - 0,75 kW - 1,1 kW
 VELOCIDADE DE ROTAÇÃO DO CHUCK - 7 RPM - 2V 6,5 - 13 RPM
 NÍVEL DE RUÍDO EM EXECUÇÃO: <70 dB

STEPLINE 3500

AUTOMÁTICA



OPCIONAL
 HELPER HTB
 21 - 8-11900261

HELPER HTB 21 - 8-11900261

€ 640

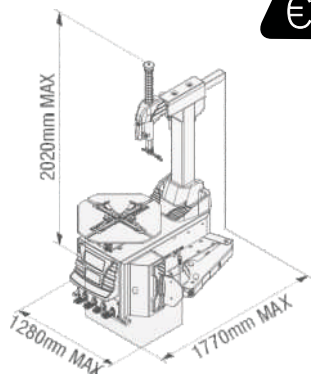

STEPLINE 3500 1V 380V 0-11901401/16 € 1.600

STEPLINE 3500 2V 380V 0-11901421/16 € 1.690

STEPLINE 3500 2VTI 380V
 COM INFLATOR
 0-11901431/16 € 1.890

OPÇÃO MONOFÁSICO ACRESCE 130 EUROS



STEPLINE 4000 TI 2V



COM INFLATOR
INCORPORADO

GRAMPO EXTERIOR - 11" - 24"
BRAÇO INTERNO - 13" - 26"
MÁX. DIÂMETRO DA RODA - 1100 mm
LARGURA DO PNEU - 3" A 14"
ABERTURA DAS MORSAS - 380 mm
PODER QUEBRA O ROLAMENTO - 2800 N
PRESSÃO DO AR DE TRABALHO - 8 - 10 bar
POTÊNCIA DO MOTOR (PEDAL DUAS VELOCIDADES) - 0,85 kW - 1,1 kW
VELOCIDADE DE ROTAÇÃO DO CHUCK - 7 RPM - 2V 6,5 - 13 RPM
NÍVEL DE RUÍDO EM EXECUÇÃO: <70 dB
BRAÇO DE APOIO OPCIONAL NÃO INCLUIDO

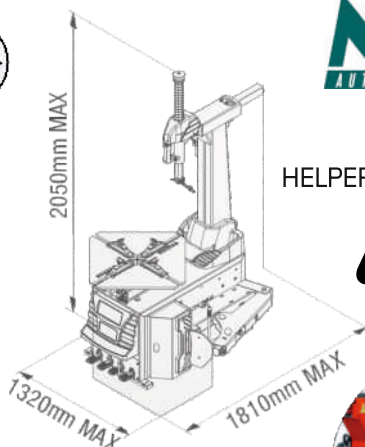

NEXION
AUTOMOTIVE SOLUTIONS

HELPER HTB 24 - 8-11900260

€ 720



001901331/16

€ 2.390

OPÇÃO MONOFÁSICO ACRESCE 130 EUROS



STEPLINE 4000 2V

RECOMENDADO PELA



GRAMPO EXTERIOR - 11" - 24"
BRAÇO INTERNO - 13" - 26"
MÁX. DIÂMETRO DA RODA - 1100 mm (42")
LARGURA DO PNEU - 3" A 14.5"
ABERTURA DAS MORSAS - 380 mm
PODER QUEBRA O ROLAMENTO - 15000 N
PRESSÃO DO AR DE TRABALHO - 8 - 10 bar
PEDAL DUAS VELOCIDADES
NÍVEL DE RUÍDO EM EXECUÇÃO: <70 dB

COM BRAÇO HELPER
HTB24
8-11900260

€ 720

INCLUI ACESSÓRIOS



STEPLINE4000 € 2.190

OPÇÃO MONOFÁSICO ACRESCE 130 EUROS
0-11901321/16





TECO 480 TOP TI LEVERLESS 380V



CAPACIDADE DE FIXAÇÃO - 10" - 27"
 FIXAÇÃO EXTERNA - 10" - 24"
 APERTO INTERNO - 13" - 27"
 DIÂMETRO MÁX. DA RODA - 1040 mm - 41"
 LARGURA MÁX. DA RODA - 14"
 FORÇA DO BALÃO - 2.900 KGf
 VELOCIDADE DE ROTAÇÃO - 8.5 RPM
 PRESSÃO DO AR DE TRABALHO - 8 - 10 bar
 MOTOR MODELO TRIFÁSICO - 0.8-1.1 KW
 MOTOR MONOFÁSICO - 0.75 KW (1.0 HP)



DIMENSÕES
 ALTURA - MÁX 1170 MM
 LARGURA - MÁX 1450 MM

AUTOMÁTICA

0-11634906/16

€ 8.998

ACESSÓRIOS INCLUÍDOS

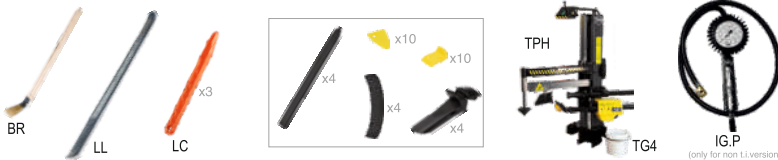

INCLUÍDO BRAÇO DE APOIO TP4
 OPÇÃO MONOFÁSICO ACRESCE 360 EUROS

OPCIONAIS
 PLS2 - ELEVADOR PNEUMÁTICO
 60 KG

€ 650



INCLUI ACESSÓRIOS

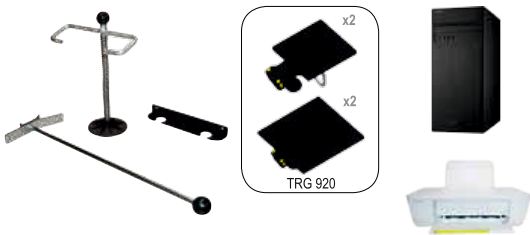

TECO 920

TECNOLOGIA DE 2 CÂMARAS DIGITAIS DE ALTA RESOLUÇÃO
 4 ALVOS VISUAIS ANTICHOQUE
 4 GARRAS DE FIXAÇÃO DE 11" A 26"
 BANCO DE DADOS COM MAIS DE 40.000 VEÍCULOS
 EQUIPADO COM PC INTEL
 SISTEMA OPERACIONAL WINDOWS 10 PRO
 PRECISÃO DE ALINHAMENTO - 0.01°
 LINGUAGEM EM PORTUGUÊS
 IMPRESSORA E MONITOR INCLUÍDOS.

FULL PACK 2

ALTURA 2918
 LARGURA 2878
 DA BASE AOS PRATOS DE 1800 A 3000
 CÂMARAS TRABALHA DE 500 A 2560 DE ALTURA

€ 11.900



MÁQUINAS PARA PNEUS



TECO 990

SIMPLES, RÁPIDA E PRECISA

TOPO DE GAMA

ALINHAMENTO
COMPATÍVEL
COM ADAS

FUNÇÃO ROC SMART INCLUÍDA

4 CÂMARAS HI-Q DE ALTA RESOLUÇÃO
COM INDICADORES LUMINOSOS
ELEVADOR INTEGRADO NA COLUNA COM SEGUIMENTO
AUTOMÁTICO DOS TARGET
PC COM WINDOWS E NOVO SOFTWARE MULTIMARCAS
TARGET LEVES DE ALTA RESOLUÇÃO E ANTI REFLEXO
PAÍNEL SINÓTICO LUMINOSO JUNTO AS CÂMARAS
ESPAÇO DE INSTALAÇÃO REDUZIDO
MAIS DE 84.000 CARROS E VANS
MONITOR LCD E IMPRESSORA INCLUIDOS



€ 15.990

TECNOLOGIA 3D



STEPLINE
6600 A



MÁQUINA DE CALIBRAR COM ENTRADA AUTOMÁTICA DE DADOS 8-21100238
TRAVÃO NO FINAL DO CICLO
RESGUARDO DE PROTECÇÃO INCLUÍDO
KIT DE CENTRALIZAÇÃO E BLOQUEIO INCLUÍDO
ATÉ 26"
MONOFÁSICA - 230 V

0-21900036/00

€ 2.060

LASER & 8-21100238
LED KIT € 319

ACESSÓRIOS INCLUIDOS



8-21100091 FRU-SA D.40
FALANGE 5 PERNOS

€ 650



STEPLINE
6800 A



COM MONITOR
GRÁFICOS ALTA RESOLUÇÃO
SOFTWARE ITALIANO
COM MONITOR
GRÁFICOS ALTA RESOLUÇÃO
SOFTWARE ITALIANO

0-21900038/00

€ 2.790

OPCIONAIS:
FRU-SA D.40
FALANGE UNIVERSAL 5 PERNOS Ø90X210MM

ACESSÓRIOS INCLUIDOS



8-21100091

€ 650

LASER & 8-21100238
LED KIT € 319

KIT MOTOS
BUK BASIC

8-21900210

€ 599

EXTENSÃO
PRA5 - Ø14 MM
PARA MOTOS

8-21900225

€ 72



TECO 680 COM KIT LASER & LIGHT

COM MONITOR INCLUÍDO
LANÇAMENTO MOTORIZADO DE BAIXO RUÍDO
MÁX. DIÂMETRO DA RODA - 28"
AJUSTÁVEL MANUALMENTE ATE 35"
LARGURA DO PNEU - 1.5" A 20"
PESO MÁXIMO DA RODA - 75 KG
DIÂMETRO DO EIXO - 40 MM
VELOCIDADE DE ROTAÇÃO - 90-130 RPM
PRECISÃO DE EQUILÍBRIO +/- 1 GR
TEMPO DE CICLO - 7 S
FONTE DE ALIMENTAÇÃO - 230 V - 50 / 60 HZ
PESO - 75 KG - PONTO A LASER INCLUÍDO

0-21611710/16+8-211100238

€ 4.280

8-21100091

FRV-SAD D.40 Ø90X210MM

FALANGE UNIVERSAL PARA RODAS 3, 4 E 5 FUROS
(MODELOS TECO 600, 670 E 680)

€ 650



KIT SONAR TS

8-21100232 € 590

MEDIÇÃO AUTOMÁTICA DA MEDIDA DA RODA



ENTRADA MANUAL DE PARÂMETROS
LANÇAMENTO MOTORIZADO DE BAIXO RUÍDO
MÁX. DIÂMETRO DA RODA - 28"
AJUSTÁVEL MANUALMENTE ATE 35"
LARGURA DO PNEU - 1.5" A 20"
PESO MÁXIMO DA RODA - 75 KG
DIÂMETRO DO EIXO - 40 MM
VELOCIDADE DE ROTAÇÃO - 90-130 RPM
PRECISÃO DE EQUILÍBRIO +/- 1 GR
TEMPO DE CICLO - 7 S
FONTE DE ALIMENTAÇÃO - 230 V - 50 / 60 HZ
PESO - 75 KG

TECO 670

0-21667010/16 € 3.090



KIT LASER LIGHT

8-21100238

€ 310



KIT TS SONAR SENSOR

8-21100232

€ 590



8-211000911 - FRU-SAD D.40 Ø90X210MM

FALANGE UNIVERSAL PARA RODAS 3, 4 E 5 FUROS
(MODELOS TECO 600, 670 E 680)

€ 650



MEDIÇÃO AUTOMÁTICA DA MEDIDA DA RODA



STEPLINE TECO 9300 TRUCK



EQUIPADO COM TODOS OS PROGRAMAS MAIS AVANÇADOS
7 PROGRAMAS DE CALIBRAGEM
DIÂMETRO MÁXIMO RODA - 1200 MM
PESO MÁXIMO DA RODA - 200 KG
DIÂMETRO MÁXIMO LEITURA DIGITAL 28" (MANUAL 35")
CALIBRAGEM RÁPIDA E FÁCIL
MULTIOPERADOR - 2 OPÇÕES DE TRABALHO
FUNÇÃO INSPECÇÃO VISUAL
MODO STAND-BY PARA POUPAR ENERGIA
8 A 12 BAR :: 1815 X 1381 MM
ACTUALIZAÇÃO DE SOFTWARE POR USB
220V

0-21900026/39

€ 4.940

ACESSÓRIOS INCLUIDOS



OPCIONAL

L&L Kit Laser Led
8 - 21900188

€ 329

IDEAL PARA CAMIÕES, AUTOCARROS E CARROS LIGEIROS

STEPLINE 5400 TRUCK



ACESSÓRIOS INCLUIDOS



COM FIXAÇÃO DE 14" A 26"
PARA RODAS COM E SEM CÂMARA DE AR
DIÂMETRO MÁXIMO DA RODA - 1500 MM
LARGURA MÁXIMA DA RODA - 780 MM
FORÇA - 16000 N - DIÂMETRO MIN - 120 MM
PESO MÁXIMO DA RODA - 700 KG
400 V

0-121021101/16

€ 6.390



STEPLINE 5500 S

ACESSÓRIOS INCLUIDOS



COM FIXAÇÃO DE 14" A 56"
 PARA RODAS COM E SEM CÂMARA DE AR
 DIÂMETRO MÁXIMO DA RODA - 2300 MM
 LARGURA MÁXIMA DA RODA - 1100 MM
 FORÇA - 28000 N - DIÂMETRO MIN - 100 MM
 PESO MÁXIMO DA RODA - 1500 KG
 400 V

0-12104301/16

€ 9.800



FAZ DE 40" A 56" COM ADAPTADOR INCLUÍDO



ACESSÓRIOS INCLUIDOS

TECO 55 A

SEMI-AUTOMÁTICA

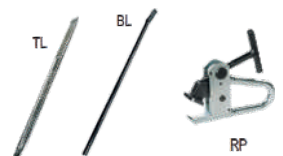

COM FIXAÇÃO DE 14" A 56"
 PARA RODAS COM E SEM CÂMARA DE AR
 DIÂMETRO MÁXIMO DA RODA - 2300 MM - 90.5"
 LARGURA MÁXIMA DA RODA - 1065 MM - 42"
 IDEAL PARA USO INTENSIVO E PROFISSIONAL
 400 V

0-12602601/16

€ 13.900

INCLUI
 OPCIONAL SE2

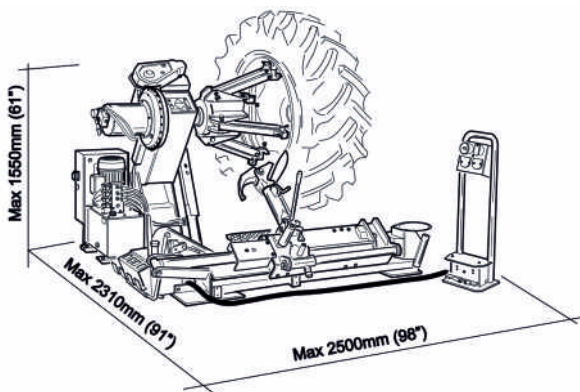

MÁQUINAS PARA PNEUS

Assetto compatibile con
Compatible with



ESPECIAL PESADOS

TECO 814 SPECIAL TRUCK



WINDOWS 10 MULTILINGUA
TRANSMISSÃO DE DADOS WIRELESS - SEM FIO
BANCO DE DADOS COM MAIS DE 40.000 VEÍCULOS
PROGRAMA ESPECIAL PARA CAMIÕES ATÉ 4 EIXOS,
REBOQUES E SEMI REBOQUES (OPCIONAL)
COMPATÍVEL COM SISTEMA UNIVERSAL PROADAS
8-11600024- 4 MEDIDORES COM 8 SENSORES CCD AS-2 12"-21"
811600025- PC AS-2 26" - 4 UNIDADES PARA EXTENSÃO AS-2 CAMIÃO
100024200- CPRA-2 PRATOS GIRATÓRIOS PARA CAMIÃO Ø365 3TON
833100111- PAR DE PADS PARA PRATOS

€ 13.900

0-33603801/16



833100111



PC AS-2



AS-2

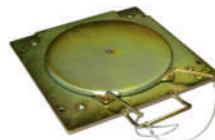

CPRA-2

ACESSÓRIOS INCLÚIDOS



BSI



BF



MNT 19

Teknox

METAL CLEANING



FAZ ATÉ 60° C - 230V
RESERVATÓRIO ÚNICO
COM PEDAL DE COMANDO
IDEAL PARA TODAS AS INDÚSTRIAS
ILUMINAÇÃO INTERIOR
PISTOLA DE AR COMPRIMIDO
TEMPERATURA E PRESSÃO AJUSTÁVEIS
TODA EM INOX AISI 304
BOMBA EM AÇO INOX
VIDRO TEMPERADO
AVISO DE NÍVEL MÍNIMO DE ÁGUA

LAVAPEN C

2C

3C

4C

DADOS TÉCNICOS	LP 3C	LP 4C
Capacidade de carga	70 kg	70 kg
Capacidade do reservatório	75 lt	90 lt
Bomba 1	5 bar 2 lt/min 2 bar 5 lt/min	5 bar 2 lt/min 2 bar 5 lt/min
Alimentação	Pneumatica	Pneumatica
	€ 4.320	€ 5.200



MÁQUINAS PARA LAVAR PEÇAS

Teknox
METAL CLEANING



OPCIONAIS

DESOLEADOR A DISCO
COM MOTORIZAÇÃO

€ 365



FILTRO PARA RECOLHA
DE SÓLIDOS E GORDURA

€ 620

FECHO ASSISTIDO - LUVAS LATEX
LANÇA ESPECIAL
PUNHO ANTIDESLIZANTE
ILUMINAÇÃO LED INTERIOR

MÁQUINA DE LAVAR
PEÇAS ALTA PRESSÃO

CAP. DE CARGA - 70 KG
RESERVATÓRIO - 75 LT
BOMBA 230 V
1.5 KW - 80 BAR 12.5 LT/MIN
1200 X 850 X 1800 ALTURA



LAVAPEN 3X

DADOS TÉCNICOS	LP 3X	LP 4X
CAPACIDADE	70 kg	70 kg
RESERVATÓRIO	75 lt	90 lt
BOMBA	1,5 kW 80 bar 12,5 lt/min	1,5 kW 80 bar 12,5 lt/min
AQUEC. DO TANQUE	3 kW	3 kW
ALIMENTAÇÃO	Monofase	Monofase

€ 5.620 € 6.120

CESTO REFORÇADO GALVANIZADO
FILTRO EM INOX 304
BOMBA ELÉTRICA EM INOX
VÁLVULA DE DESCARGA
SISTEMA DE LAVAGEM
TOTALMENTE EM INOX

MÁQUINA DE LAVAR
PEÇAS AUTOMÁTICA



P 80

€ 5.140

CAPACIDADE DE CARGA - 100 KG
RESERVATÓRIO - 130 LT
0.55 KW - 2.5 BAR - 120 LT/MIN
2.2 KW - 5 BAR - 180 LT/MIN
AQUECIMENTO DO TANQUE 4 KW
400 V - 112 X 105 X 185 CM ABERTA

gt
greentechno

LIMPEZA ULTRASONS

CAPACIDADE 160 LITROS - 100 KG
FREQUÊNCIA 40 KHZ
1500 WATTS DE ULTRASONS
4500 WATTS DE AQUECIMENTO
TRIFÁSICA 400V
PAINEL TOUCH 7' - SISTEMA SSX3
CUBA 680X440X350MM
EM INOX 304 E 316
SISTEMA UP AND DOWN
VARRIMENTO LATERAL DE SUPERFICIE
PRODUTO RECOMENDADO

ecoclean



GTS-16

€ 13.740

CAPACIDADE 160 LITROS - 75 KG
FREQUÊNCIA 40 KHZ
1500 WATTS DE ULTRASONS
3000/4500 WATTS DE AQUECIMENTO
TRIFÁSICA 400V OU MONOFÁSICA 220V
PAINEL TOUCH 4.3' - SISTEMA SSX3
CUBA 680X440X350MM
EM INOX 304 E 316
SISTEMA UP AND DOWN
VARRIMENTO LATERAL DE SUPERFICIE
PRODUTO RECOMENDADO

ecoclean



GT-MOTION

€ 12.580



MÁQUINAS DE ALINHAR FARÓIS

Reference



1540-LJN5413

€ 420



ADEQUADO PARA VERIFICAR E AJUSTAR QUALQUER TIPO DE FAROL (FAROL ALTO, BAIXO E FAROL DE NEBLINA) MIN 250 - MAX 1350 MM INCLUSIVE FARÓIS COM LÂMPADAS XENON E LED.
INDICADO PARA VEÍCULOS LIGEIOS, PESADOS E MOTOS.
TELA DE MIRA INTERNA COM ESCALA PARA VEÍCULOS COM VOLANTE À DIREITA E À ESQUERDA.
VISOR DE ALINHAMENTO DE FIO DE AÇO COM SISTEMA DE CALIBRAÇÃO.
SISTEMA DE AJUSTE DE ALTURA COM SISTEMA DE TRAVAMENTO.
LUXÍMETRO DIGITAL.
USO CONFORTÁVEL DEVIDO AO POSICIONAMENTO DAS RODAS
BASE ANTI-QUEDA ROBUSTA.
FORNECIDO COM MANUAIS DE MONTAGEM, OPERAÇÃO E CALIBRAÇÃO.

DOUBLE LASER

Reference



LH5415-LJN5416

€ 645



ADEQUADO PARA VERIFICAR E AJUSTAR QUALQUER TIPO DE FAROL (FAROL ALTO, BAIXO E FAROL DE NEBLINA), MIN 250 - MAX 1350 MM INCLUSIVE FARÓIS COM LÂMPADAS XENON E LED.
INDICADO PARA VEÍCULOS LIGEIOS, PESADOS E MOTOS.
TELA DE MEDIÇÃO REGULÁVEL INTERNA COM ESCALA PARA VEÍCULOS COM VOLANTE À DIREITA E À ESQUERDA.
VISOR DE ALINHAMENTO A LASER + APONTADOR LASER CENTRAL PARA FACILITAR O POSICIONAMENTO DA UNIDADE NA FRENTE DO VEÍCULO.
SISTEMA DE AJUSTE DE ALTURA COM SISTEMA DE TRAVAMENTO.
LUXÍMETRO DIGITAL.
USO CONFORTÁVEL DEVIDO AO POSICIONAMENTO DAS RODAS.
FORNECIDO COM MANUAIS DE MONTAGEM, OPERAÇÃO E CALIBRAÇÃO.



MÁQUINA SEMI AUTOMÁTICA PARA MUDANÇA DE OLEO DE CAIXAS AUTOMÁTICAS

DISPLAY GRÁFICO 240X64 - APENAS 4 BOTÕES
SOFTWARE INTUITIVO MULTI-LÍNGUA
MEDIÇÃO DE PRESSÃO DE RETORNO
SELECÇÃO DE PESO ESPECIFICO DO ÓLEO KG/LT
2 BALANÇAS ELECTRÓNICAS - 1 BOMBA 220V
MODO MANUAL OU AUTOMÁTICO
PROTEÇÃO CONTRA SOBRE-PRESSÃO COM RECIRCULAÇÃO AUTOMÁTICA
COMPENSAÇÃO DO COMPRIMENTO DAS MANGUEIRAS
ACTUALIZAÇÃO DE SOFTWARE POR PEN



02.023.60

€ 3.900





MÁQUINAS PARA REVISÃO E MANUTENÇÃO DE CAIXAS AUTOMÁTICAS



TABLET WI-FI DE 8" 4G
CONSULTA DIRECTA DA BASE DE DADOS EM LINHA (POR 4G OU WI-FI)
CONTROLO REMOTO DAS FUNÇÕES E MONITORIZAÇÃO DAS OPERAÇÕES EM CURSO ATRAVÉS DAS ATF'S
BASE DE DADOS INTEGRADA- RECONHECIMENTO E INVERSÃO AUTOMÁTICA DO FLUXO DE ÓLEO (ELECTRONICAMENTE)
REGULADOR DE REDUÇÃO DO FLUXO DE ENTRADA (INCORPORADO)
DIAGNÓSTICO INTEGRADO COM MENSAGENS E GUIA RELACIONADO PARA O SERVIÇO.
PROCEDIMENTO MELHORADO PARA A SUBSTITUIÇÃO DE NOVOS TANQUES DE ÓLEO (OUTROS TANQUES A PEDIDO)
FUNÇÕES GUIADAS PARA PROCEDIMENTO MANUAL
GUIA DE FUNÇÕES PARA LAVAGEM DO RADIADOR E SUBSTITUIÇÃO DO FILTRO
PROCEDIMENTO ESPECÍFICO PARA DSG
ALIMENTAÇÃO DUPLA DE 12V DC E 220V AC
COM ALARME DE BATERIA FRACA E AUTOMÁTICO RECONHECIMENTO DA FONTE DE ENERGIA
IMPRESSORA INCLUÍDA
ACESSO DIRECTO AO ÓLEO USADO PARA O ESVAZIAMENTO DE PAINÉIS
KIT DE ACESSÓRIOS E MANGUEIRAS PARA AUTOMÓVEIS EUROPEUS E ASIÁTICOS



02.023.66

€ 5.950

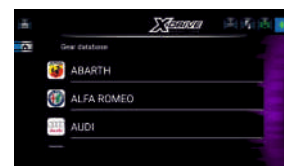

BASE DE DADOS ONLINE COM INFORMAÇÃO TÉCNICA SOBRE A CAIXA (DIAGRAMAS, FOTOS, LOCALIZAÇÃO DOS ACESSÓRIOS, ETC.)



ECRÃ TÁCTIL CA CORES DE 5"
MEDIÇÃO DA PRESSÃO DO ÓLEO
SOFTWARE MULTI-LÍNGUA - FUNÇÃO AWS
FUNÇÃO DE AQUECIMENTO AUTOMÁTICO
SISTEMA INTEGRADO DE INVERSÃO DO FLUXO DO ÓLEO
2 NOVOS FILTROS COM ÍMAN
INJECCÃO AUTOMÁTICA DE ADITIVO
BASE DE DADOS ACTUALIZÁVEL POR USB
TANQUES DE ÓLEO 2X20 LTS NOVOS E RESÍDUOS
KIT DE ENGATES E MANGUEIRAS PARA VEÍCULOS EUROPEUS E ASIÁTICOS INCLUÍDO
SMARTPACK (12 MESES DE ACESSO GRATUITO À BASE DE DADOS EM LINHA)
SOFTWARE PARA MUDANÇA DE ÓLEO DE DIRECÇÃO ASSISTIDA
BASE DE DADOS INTEGRADA COM MARCA, VERSÃO, NÚMERO DE RÁCIOS, TIPO DE CAIXA DE VELOCIDADES, QUANTIDADE DE ÓLEO E CÓDIGO DO ÓLEO
IMPRESSORA OPCIONAL

ATF S-DRIVE 4500 SW



BASE DE DADOS ONLINE COM INFORMAÇÃO TÉCNICA SOBRE A CAIXA (DIAGRAMAS, FOTOS, LOCALIZAÇÃO DOS ACESSÓRIOS, ETC.)

02.023.90 € 4.560





HANDY ADVANCE EVO



DISPLAY GRÁFICO DE 4.7" COM IMPRESSORA
 BASE DE DADOS INTEGRADA
 INJEÇÃO DE ÓLEO PADRÃO/ADITIVO E INJEÇÃO DE ÓLEO
 HÍBRIDO (MULTI-OIL SYSTEM)
 MULTI LINGUA - GESTÃO DE OPERADOR
 PORTA USB - BOMBA 70 LT/MIN
 TANQUE - 10 KG | COMPRESSOR 300 GR/MIN
 RECUPERAÇÃO AUTOMÁTICA
 DESCARGA DE ÓLEO AUTOMÁTICA
 CARGA DE GÁS AUTOMÁTICA
 LAVAGEM AUTOMÁTICA EM CASO DE MUDANÇA DE ÓLEO



GÁS R1234YF
 01.028.63 € 2.655

GÁS R134A
 01.028.61 € 2.655



MONOCLIMA BI POWER 134

COMPRESSOR DE RECUPERAÇÃO
 AUTOMÁTICA DOS OLEOS
 BOMBA DE VACUO - 3M3/H
 CAPACIDADE DO CILINDRO - 4.4 KG
 220 V 50 HS / 12 V DC
 INJECTOR DE OLEO FRESCO



PARA USO EXTERNO
 IDEAL PARA MÁQUINAS AGRICOLAS
 E MOVIMENTADORAS DE TERRA

01.009.02
 BI POWER € 2.780

MONOCLIMA BIPOWER 12V DC-220V AC
 COD. 01.009.02



BREEZE ADVANCE DUAL 01.001.43

BANCO DE DADOS INTEGRADO
 COM ACTUALIZAÇÕES DISPONÍVEIS
 DOIS TIPOS DE GÁS
 COM IMPRESSORA DE SERIE
 LIMPEZA AUTOMÁTICA DOS TUBOS
 DO ÓLEO E CIRCUITOS.
 PORTA USB
 SOFTWARE MULTI LINGUAS
 DISPLAY GRÁFICO (A)
 MÁXIMA EFICIÊNCIA (95% DO GÁS)

R 134a 4 MANGUEIRAS
 HFO1234 YF 4 ADAPTADORES

IDEAL PARA CARROS LIGEIROS, HYBRIDOS
 CAMIÕES, MÁQUINAS AGRICULAS

2 TANQUES
 2 X 10 KGS

€ 5.280



BST SYSTEM



SEM CONTAMINAÇÃO INTERNA. 2 EVAPORADORES
 2 COMPRESSORES, 2 CONDENSADORES, 2 TANQUES, 2 FILTROS
 E LAVAGEM INTERNA AUTOMÁTICA A CADA TROCA.





CARRO MULTIFUNÇÕES



3 PRATELEIRAS DE ARRUMAÇÃO
 1 PRATELEIRA PARA TECLADO DESLIZANTE
 SUPORTE PARA ROLOS
 3 PRATELEIRAS LATERAIS
 UM COMPARTIMENTO COM CHAVE
 2 RODAS FIXAS - 2 GIRATÓRIAS (1COM TRAVÃO)
 DIMENSÕES: 48 X 60 X 107 CM
 PESO 37KG

05.088.105

€ 420



DETETOR DE FUGAS ELETRÓNICO

01.000.203M

€ 230



MULTIGÁS:
 CFC, HCFC, HFO1234YF,
 R134A, N2-H2

DETETOR DE FUGAS ELETRÓNICO LED

01.000.100

€ 113

MULTIGÁS:
 R134a, R22, R404



TERMOMETRO

04.013.05

€ 42



TERMOMETRO DE INFRAVERMELHOS DIGITAL -50° / + 40°
 MEDIÇÃO DE TEMPERATURA SEM CONTACTO
 DESLIGA-SE AUTOMÁTICAMENTE
 RELAÇÃO DISTÂNCIA 12:1



MEDIDAS - 420x420x965
 LEVA 70 KG
 PESA 5 KG

CARRO

05.088.03

€ 48



MEDIDAS - 730x475x835
 LEVA 100 KG
 PESA 8.1 KG

CARRO

05.088.25

€ 55





MÁQUINA LIMPEZA RADIADORA

UNIDADE DE LIMPEZA AUTOMÁTICA DO RADIADOR E SUBSTITUIÇÃO DO LÍQUIDO DE ARREFECIMENTO

LÍQUIDO DE ARREFECIMENTO PARA AUTOMÓVEIS E VEÍCULOS COMERCIAIS ATÉ 3,5 TONELADAS

SOFTWARE MULTI-LÍNGUA
PURGA DE AR DA UNIDADE WS 4000
IMPRESSORA INCLUÍDA

WS 4000
02.021.10

€ 2.760



02.000.99
URAN

€ 10



02.000.98
ZEUS

€ 12

LUBRIFICANTE COM PROTEÇÃO ANTICORROSIVA, 500 ML, ADEQUADO PARA SISTEMAS ATÉ 8 LTS

LÍQUIDO DESCARBONIZANTE DE LAVAGEM, 500 ML, ADEQUADO PARA SISTEMAS ATÉ 8 LTS



MÁQUINA PORTÁTIL DE LIMPEZA DE CIRCUITO

PROCESSOS DE MANUTENÇÃO MAIS RÁPIDOS:
REMOVE OS RESÍDUOS DE CARBONO DAS PAREDES E CONDUTAS DE ASPIRAÇÃO SEM DESMONTAR PEÇAS

ECRÃ TÁTIL
RELATÓRIOS DE FIM DE TRATAMENTO/AVISOS SONOROS
TENSÃO DE ENTRADA: 10-16V DC
COM LIGAÇÃO À BATERIA
POTÊNCIA: 15W
DEPÓSITO: 2L
LEVE E COMPACTA

AICS
02.013.17

€ 2.290



02.013.19

HIDRÓXIDO DE POTÁSIO

KOH, 1 KG

€ 45



02.013.18

LÍQUIDO PARA DESCARBONIZAÇÃO DOS CIRUCUITOS VENTILAÇÃO

1 LT

€ 35



02.013.16

BARRA TRAVAMENTO PEDAL DE ACELERAÇÃO

€ 55



EXTRAÇÃO DE FUMO E BATE CHAPAS



VÁRIAS MEDIDAS DISPONÍVEIS CONFORME
NECESSIDADE DE APLICAÇÃO
PREÇO SOB CONSULTA



CARRIL EM ALUMÍNIO EXTRUDIDO
ACESSÓRIOS DO CARRO EM INOX
SISTEMA MÓVEL COM APLICAÇÃO
LATERAL OU SUPERIOR

EXTRAÇÃO DE FUMOS E GASES PARA OFICINA



DUPLO

SUporta até 210° C
Potência 0.55 KW
CAUDAL 1420 MT/H
400 V (230V OPCIONAL)
TUBOS COM 7 METROS

FU-2V-75/7

€ 1.990



SIMPLES

SUporta até 210° C
Potência 0.18 KW
CAUDAL 1000 MT/H
400 V (230V OPCIONAL)
TUBOS COM 7 METROS

FU-1V-75/7

€ 1.290

KIT TUBO DUPLO PARA UNIDADE MÓVEL



COMPOSTO POR:
CONNECTOR EM «Y»
2 MANGUEIRAS COM 1M
2 BICOS DE BORRACHA

FU POR - Y

€ 641

SISTEMA DE BOCAL SIMPLES



TUBO DE SAÍDA Ø 150MM
10 METROS
ASPIRADOR 1.0 HP

FU POR - I/I

€ 1.470



CONSULTAR FOLHETO PARA MEDIDAS DE BRAÇOS E OPCIONAIS

CAPACIDADE 2+2MM - 220V
 POTÊNCIA CONVÊNIONAL A 50% - 15kva
 CONTROLADA POR MICRO PROCESSADOR DIGITAL 4
 CONFIGURAÇÃO AUTOMÁTICA DE PARÂMETROS
 NA MUDANÇA DE FERRAMENTA
 PISTOLA LEVE E COMPACTA
 FORÇA DO ELETRODO 190 daN
 CABOS FLEXIVEIS DE SECÇÃO 150 MM E 2.2 MTS
 AQUECIMENTO E ENDIREITAMENTO
 SOLDA FORTE DE PINOS, ARREBITES, PARAFUSOS,
 ARRUELAS E PREGOS.
 SOLDA DE PONTO ÚNICO EM ÁREAS FECHADAS

PRIMA SPOT 85
 8500A DE POTÊNCIA



€ 3.465

60010007

INCLUÍ BRAÇOS DE 200MM

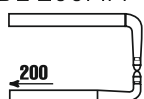

B51 cod 6001-05-02

OPCIONAIS:

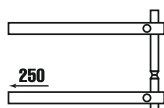

B56 cod 6001-05-08

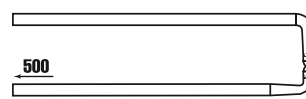

B57 cod 6001-05-09

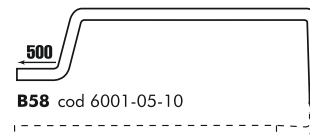

B58 cod 6001-05-10

€ 120

€ 167

€ 198

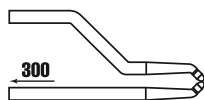

B52 cod 6001-05-03

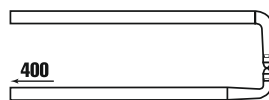

B53 cod 6001-05-04

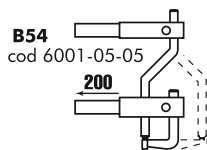

B54 cod 6001-05-05

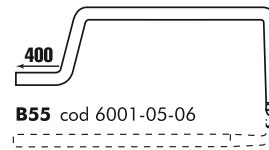

B55 cod 6001-05-06

€ 133

€ 144

€ 278

€ 167

PRIMA

SPOTTER PARA FERRO E ALUMINIO



CARRO CAR 2

€ 390

50010700

PREÇO CONJUNTO

€ 1.940



PRIMA TOPCAR 30

€ 1.550

50010028

3000 A SPOT
 MICROPROCESSADOR



QUICK PULLER

€ 724

50020111



EASY CAR 300

€ 1.166

50010027



DIAGNÓSTICO E BATERIAS



BOOSTER
BOCIA EVO

PICO DE 2000A
CONTACTOS EM BRONZE
CONTROLO DE CARGA
ALARME DE POLARIDADE
NOVA BATERIA 12V 22Ah
2000A

03.015.03

€ 255



CARREGADOR PARA
BOCIA EVO

03.015.04.R1

€ 58



BOOSTER
BOCIA EVO

PICO 4000A
VOLTÍMETRO
CONTACTOS EM BRONZE
CONTROLO DE CARGA
ALARME DE POLARIDADE
NOVAS BATERIAS 2X12V
22Ah / 4000A

03.015.04

€ 471



MARCO TOOLS
by SPIN

CABOS DE BATERIA



PURE 100% COPPER
RAME PURO 100%

1000 A - 70 MM
5 MTS - 05.060.04J

€ 150



350 A - 25 MM
3.5 MTS - 05.060.02

€ 29

480 A - 35 MM
4.5 MTS - 05.060.03

€ 43

HELVI

ANÁLISE DE BATERIAS PROFESSIONAL

12/24V



POLARIDADE INVERSA
PROTECÇÃO CONTRA CURTO CIRCUITO
ECRÃ LCD TOUCH COM GRÁFICOS A CORES
WET, AGM, AGM Spiral EFB, CA & GEL
CCA, SAE, EN, EN1, EN2, IEC, DIN, CA/MCA, JIS
ALTERNADOR E TESTE DE ARRANQUE
TESTE DE LIGAÇÃO À TERRA
IMPRESSORA INCORPORADA
TRANSFERÊNCIA DE DADOS
PARA O PC

T13 TESTE DE BATERIAS
E ANALISADOR
99090039

€ 385



BOOSTER - LITIO - COM PROTECÇÃO

POLARIDADE INVERSA
PROTECÇÃO CONTRA CURTO CIRCUITO
ECRÃ LCD TOUCH COM GRÁFICOS A CORES
WET, AGM, EFB, CA & GEL
CCA, SAE, EN, IEC, DIN, CA, JIS
TESTE DE ALTERNADOR
TESTE DE ARRANQUE
TRANSFERÊNCIA DE DADOS
PARA O PC



T5 TESTE DE BATERIAS
E ANALISADOR
99090038

€ 235



CARREGADORES DE BATERIA



9900069

GAMA SEMI PROFISSIONAL

9900068

12.5A - 12/24V - 300W
CORRENTE DE CARGA 8.5 A



PROGRESS 17

€ 113

PROGRESS 20

€ 156

11A - 12/24V - 390W
CORRENTE DE CARGA 7.5 A

25A - 12/24V - 600W
CORRENTE DE CARGA 17 A

9900072

ARTIK 33

€ 186



18A - 12/24V - 430W
CORRENTE DE CARGA 12 A

9900077

ARTIK 22

€ 167



9900074

DISCOVERY 60

€ 77

4A - 6/12V - 65W
PARA AGM, GEL, LEAD E
START STOP, LIFePO e Ca/Ca



9900083

DISCOVERY 120 PLUS

€ 95

12V 16A - 24V 8A - 135W
PARA AGM, GEL, LEAD E
START STOP, LIFePO4 e Ca/Ca

27A - 12/24V - 650W
CORRENTE DE CARGA 18 A
PARA BATERIAS DE CHUMBO
BOOSTER MAX 220Acc

9900502

SPEEDY 250

€ 205



30A - 12/24V - 720W
CORRENTE DE CARGA 20 A
AUTOMÁTICO
PARA AGM, GEL, LEAD E
START STOP
PROFISSIONAL

AUTOMATIC 30

€ 360



9900066

42A - 12/24V - 1000W
CORRENTE DE CARGA 28 A
PARA BATERIAS DE CHUMBO
BOOSTER MAX 380Acc

99005031

SPEEDY 430

€ 314



CARREGADORES DE BATERIA



DIAGNÓSTICO TOTAL MOTOS
 REPROGRAMAÇÃO DE MOTORES
 REPARAÇÃO E SERVIÇO
 TESTE DE COMPONENTES
 ACTUALIZAÇÕES PERIÓDICAS
 CHAVES DE CODIFICAÇÃO
 CORTE E AJUSTE DE IMOBILIZADOR
 PROGRAMAÇÃO AO RALENTI
 REGISTO DE DADOS

MEMOBIKE 6050 € 2.290

BOOSTER

CABOS ESPECIAIS OPCIONAIS

MULTI
 MARCAS

FICHA OBD

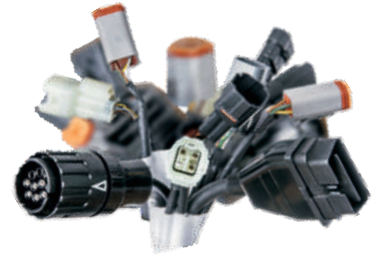

MemoBike 6050



TESTE BATERIA/
 ALTERNADOR DIGITAL

TESTE DE BATERIA/ ALTERNADOR
 DIGITAL DE 12V - POSSIBILIDADE
 DE LIGAR AO ISQUEIRO

99090040

€ 25,50



POWER UP 8.0

ENTRADA 5V-2A
 SAÍDA 5V-3A/9V-2A
 ARRANQUE DE SAÍDA - 12V



99005067

€ 102

POWER UP 13.0



ENTRADA 5V-3A
 SAÍDA 5V-3A
 ARRANQUE DE SAÍDA - 12V

99005069

€ 129



CARREGADOR ESTABILIZADOR DE TENSÃO

FUNÇÃO
 AUTO DETECÇÃO

100A - 12V - 1600W

99000084
 EXPLORER 120

€ 950

99000085
 EXPLORER 130

€ 1.120



PROTEÇÃO CONTRA CURTO-CIRCUITOS
 INVERSÃO DE POLARIDADES E SOBRECARGAS
 IDEAL PARA USAR EM DIAGNÓSTICO

120A - 12V - 2600W
 CORRENTE DE CARGA 120 A
 PARA AGM, GEL, LIQUIDO E
 LÍTIO (LiFePO4) PROFISSIONAL



CARREGADORES DE BATERIA



GAMA PROFISSIONAL

75A - 12/24V - 1800W
MAX BOOST 580 Acc
BATERIAS DE CHUMBO
COM AMPERIMETRO



2 OPERADORES
NECESSÁRIOS

SPRINTCAR 640
99010030

€ 570



60A - 12/24V - 1440W
MAX BOOST 330 Acc
BATERIAS DE CHUMBO
COM AMPERIMETRO

SPRINTCAR 540

99010041 € 478



CARREGADOR COM BOOSTER

45A - 12/24V - 1000W -
CONECTOR 25 MM
MAX BOOST 300 Acc
PARA BATERIAS DE CHUMBO
COM AMPERIMETRO

99010046
SPRINTCAR 341

€ 310

CARREGADOR COM BOOSTER



55A - 12/24V - 1320W
CONECTOR 25 MM
MAX BOOST 450 Acc
CORRENTE DE CARGA 36 A
PARA BATERIAS DE CHUMBO

99005053
RAPID 480

€ 369



99005041
RAPID 380

€ 260



CARREGADOR COM BOOSTER

38A - 12/24V - 900W
MAX BOOST 280 Acc
CORRENTE DE CARGA 25 A
PARA BATERIAS DE CHUMBO





PR412SXI000

€ 780

GERADOR A GASOLINA
WX5000

4650 W
ARRANQUE MANUAL
230V
78 KG



TRIFÁSICO

WX6250

6.1 KW MÁX
5.5 KW CONTÍNUA
GASOLINA - 400/230V
ARRANQUE ELÉTRICO + MAN
90 KG - 3000 RPM
2 TOMADAS 16A
1 TOMADA 3P+N+T 400V 16A
VOLTÍMETRO E CONTA HORAS
POT. MAX EM MONOFÁSICO 1.8 KW

€ 1.050

PR552TXBZ00

PRAMAC



6100 WATTS MÁX
5800 WATTS CONTÍNUA
GASOLINA - 230V
ARRANQUE ELÉTRICO + MAN
90 KG - 3000 RPM
2 TOMADAS 230V 16A
1 TOMADA 2P+T CEE 230V 32A
VOLTÍMETRO E CONTA HORAS

GERADOR A GASOLINA
WX7000

PR582SXBZ00

€ 1.080

PRAMAC



GERADOR A GASOLINA
WX3200

2.9 KW MÁX
2.5 KW CONTÍNUA
ARRANQUE MANUAL RECOIL
GASOLINA - 230V - 50HZ
49 KG - 3000 RPM
2 TOMADAS 16A
VOLTÍMETRO E CONTA HORAS

PR242SXIZ00

€ 510



GERADOR A GASOLINA
WX6200

5.8 KW MÁX
5.3 KW CONTÍNUA
ARRANQUE MANUAL RECOIL
GASOLINA - 230V - 50HZ
49 KG - 3000 RPM
2 TOMADAS 16A
1 TOMADA 2P+T 32A CEE
VOLTÍMETRO E CONTA HORAS

PR532SXIZ00

€ 899



SÉRIE PROFISSIONAL MONOFÁSICOS



MOTOR HONDA Gx160
 2600 WATTS MÁX
 2200 WATTS CONTÍNUA
 GASOLINA 230V 50HZ
 ARRANQUE MANUAL

E3200

€ 845

PRAMAC

SÉRIE PROFISSIONAL MONOFÁSICOS



PA432SH1000
 E5000

MOTOR HONDA GX270
 4.600 WATTS MÁX
 3.900 WATTS CONTÍNUA
 GASOLINA 230V 50HZ
 ARRANQUE MANUAL

€ 1.350



PA652SH1000
 E8000

MOTOR HONDA GX390
 6.4 KW MÁX
 5.5 KW CONTÍNUA
 GASOLINA 230V 50HZ
 ARRANQUE MANUAL

€ 1.780

PRAMAC

SÉRIE PROFISSIONAL MONO / TRIFÁSICO

MOTOR HONDA GX390
 6.6 KW MÁX 400V
 5.6 KW CONTÍNUA 400V
 3.6 KW MAX 230V
 3.3 KW CONTINUA 230V
 GASOLINA
 400/230V 50HZ
 ARRANQUE MANUAL

PA702TH1000
 E8000

€ 1.980

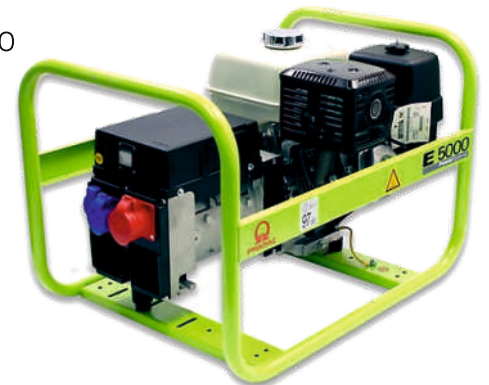
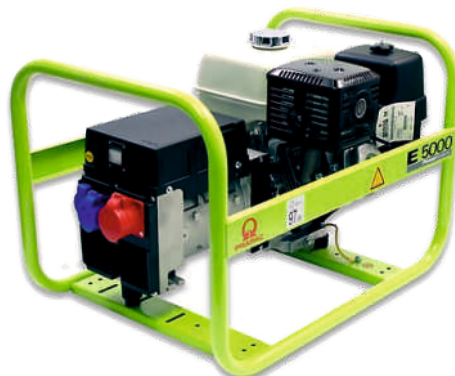

MOTOR HONDA GX270
 5.0 KW MÁX 400V
 4.3 KW CONTÍNUA 400V
 3.4 KW MAX 230V
 3.2 KW CONTINUA 230V
 GASOLINA
 400/230V 50HZ
 ARRANQUE MANUAL

PA542TH1000
 E5000

€ 1.795



PORTA PALETES 2.5 TON



Conforms to EN ISO3691-5
Based on Directive 2006/42/EC

ISO 9001
ISO 14001
ISO 45001



YPT 2552

€ 370

2 RODAS POLIURETANO 80X70MM
RODA CENTRAL EM POLIURETANO
1150X540MM



FPT 25

€ 355

4 RODAS POLIURETANO À FRENTE
1 RODA POLIURETANO DUPLA ATRÁS
1150X540

PRAMAC

PORTA PALETES EVO GALVA



RODAS EM NYLON BRANCO REFORÇADO
1150 X 525 MM

EVO GALVA S2

2 RODAS NYLON

€ 820

EVO GALVA S4

4 RODAS NYLON

€ 830

EVO GALVA INOX II

4 RODAS NYLON

BOMBA EM INOX AISI 316

€ 3.300

PRAMAC

PORTA PALETES Px25



Px25 COM BALANÇA

1185 x 555
2.5 T
500GR

€ 1.590

PORTA PALETES GS S4 FRUTERA



GS S4 FRUTERA

1000X685
RODA POLLY
4 RODAS NYLON BRANCO

€ 599





MESA ELEVATÓRIA

ELEVAÇÃO - 900 MM
300 OU 800 KG
MANUAL COM PEDAL
815X500

LT30 € 735

LT80 € 990

PRAMAC



STACKER

ELEVAÇÃO - 1600 MM
1 TON
MANUAL
GARFOS 1150 MM

MX 1016

€ 1.580

PRAMAC



STACKER ELÉTRICO

ELEVAÇÃO - 3500 MM
1.2 TON
ELÉTRICO
COM 2 BATERIAS 12 V 85Ah
CARREGADOR DE SERIE

GX12/35 GEL

2 BATERIAS DE GEL 12V/105Ah

€ 7.479

GX12/35 € 7.087





LUBRIFICAÇÃO



ACESSÓRIOS PARA LUBRIFICAÇÃO

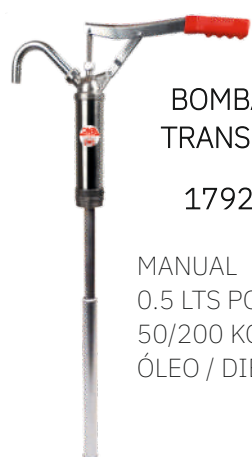

BOMBA DE TRANSFEGA

1792.PN

MANUAL
0.5 LTS POR CICLO
50/200 KG
ÓLEO / DIESEL

€ 35



BOMBA DE TRANSFEGA

1792.PR

MANUAL
30 LTS/MIN
180/200 KG
ÓLEO / DIESEL

€ 43



BOMBA DE TRANSFEGA

1792.PRP

MANUAL
ÓLEO / DIESEL / ADBLUE®
IDEAL PARA ADBLUE®
220 L
EPDM 3/4" X 930 MM

€ 68



BOMBA DE TRANSFEGA

1770.D225N

COM PISTOLA MANUAL
40 LTS/MIN
3/4 - 12 V

€ 196

1770.D226N

COM PISTOLA MANUAL
40 LTS/MIN
3/4 - 24 V

€ 205



BOMBA TRANSFEGA GASÓLEO

80 LT/MIN
230 V
1 POLEGADA
PESO: 17.2 KG



1770.D392NS € 298

CONTA LITROS GASÓLEO



20-120 LT/MIN
10 BAR
1 POLEGADA
PESO: 1.8 KG

1770.D4CM € 136

BOMBA DE ÓLEO ENGRENAGEM

10 LT/MIN
12 V
3/4 POLEGADA
PESO: 3,8 KG



1770.M12V € 183

BOMBA ADBLUE



1770.URC1
30 LT/MIN
230 V
1 POLEGADA

1770.URC6
32 LT/MIN
12 V
1 POLEGADA

€ 423

PUNHO CONTADOR ADBLUE

10-100 LT/MIN
1 POLEGADA
Peso: 0,2 kg



€ 111,50



BOMBA PNEUMÁTICA PARA ÓLEO

1775

50/60 LT
12 LT/MIN - 3:1
TUBO 730 MM

€ 268



BOMBA PNEUMÁTICA PARA ÓLEO

1776

180/220 LT
12 LT/MIN - 3:1
TUBO 940 MM

€ 261



BOMBA PNEUMÁTICA PARA ÓLEO

1779

180/220 LT
14 LT/MIN - 5:1
TUBO 940 MM

€ 266



BOMBA PNEUMÁTICA PARA MASSA

1789

180/220 LT
800 GR/MIN - 50:1
TUBO 940 MM

€ 260

BOMBA MASSA
25 KG
R=50

1787

€ 255

BOMBA MASSA
50 KG
R=50

1788

€ 255



ACESSÓRIOS PARA LUBRIFICAÇÃO



DEPÓSITOS DIESEL BONEZZI



PISTOLA DE ABASTECIMENTO INCLUÍDA



428/220-KC
220 LTS
40 LTS/MIN
BOMBA 12 V

€ 936

428/440-KC
440 LTS
40 LTS/MIN
BOMBA 12 V

€ 1.200



ENROLADOR AR / ÁGUA



1731.C4

15 MTS + 1
10X14.5 PVC
20 BAR
3/8

€ 145

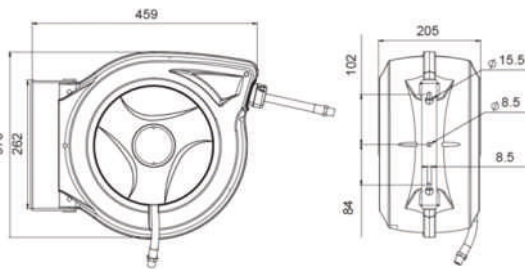

ENROLADOR AR / ÁGUA



1731.C7

20 MTS + 1
10X14.5 PVC
20 BAR
3/8

€ 150



ENROLADOR AUTOMÁTICO PARA ÓLEO



15 MTS
138 BAR
1/2' R1

1732.0

€ 388

15 MTS
155 BAR
3/8' R1

1732.0B

€ 410

ENROLADOR AUTOMÁTICO PARA MASSA



10 MTS
400 BAR
1/4' R2

1732.GA

€ 315

15 MTS
400 BAR
1/4' R2

1732.G

€ 385



BOMBA DE MASSA PNEUMÁTICA



CARRINHO INCLUIDO
MEMBRANA 285 MM
COM TAMPA
TUBO 4 MTS
PISTOLA DE MASSA COM
RECORD ROTATIVO
25-30 KG
COMPRESSÃO 50:1

1781.E

€ 415

MÁQ. SANGRAR TRAVÕES PNEUMÁTICA AUTOMÁTICA



5 LTS
6 BAR

1881

€ 310

ADAPTADOR
UNIVERSAL

1884



1885

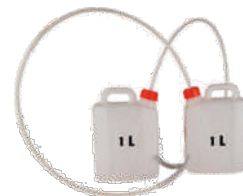

1881
COM OPCIONAIS
1884 + 1885

€ 360

easylub

ASPIRADOR / RECUPERADOR DE ÓLEO



1839.80

VISOR DE 10 LTS
APARADOR 18 LTS
80 LITROS

€ 535

ASPIRADOR RECUPERADOR OLEO - PNEUMÁTICO



1837.80

COM VISOR 10 LTS
80 LITROS

€ 430

easylub

ASPIRADOR RECUPERADOR OLEO - PNEUMÁTICO



1832.80

APARADOR 18 LTS
80 LITROS

€ 390

ASPIRADOR OLEO - PNEUMÁTICO



1830.30

30 LITROS

€ 221



MÁQUINA DE LAVAR PEÇAS



720 X 550 MM
40 KG - 25 LTS
3 DEPÓSITOS
4 NIVELADORES
MANGUEIRA COM PINCEL

TBP780

€ 516

TBP950

€ 590

MÁQUINA DE LAVAR PEÇAS

65 LITROS
220 V

1970.E

€ 227



PISTOLA PESA AR

MOSTRADOR DIGITAL

1863.DAS

€ 79

PISTOLA DIGITAL CONTA LITROS



IDEAL PARA OLEOS
1767.D BICO AUTOMÁTICO 1/2'

€ 155

ESPREMEDOR DE PANOS



MANUAL 1951

€ 152



PISTOLA FLEXÍVEL



1768.A

€ 70



MANÓMETRO DIGITAL

10-100 LT/MIN
30 BAR
3/4'

1770 DG

€ 159



CARRO TROLLEY

20/60 KG
PESO 8KG

1760.1N

€ 80



CONJUNTO COM CARRO PARA ÓLEO 180/220 LTS

COM PISTOLA DIGITAL

1762 € 630

COM PISTOLA MANUAL

1762.A € 540



ACESSÓRIOS PARA LUBRIFICAÇÃO

BOMBAS DE MASSA

1784.A

€ 45



1784.B

€ 42

PISTOLA DE MASSA
COM TUBO RÍGIDO



1786.3N

PNEUMÁTICA
400 GR
400 BAR MAX

€ 42



1786.0C

MANUAL
400 GR
400 BAR MAX

€ 29



easylub

SERINGA DE VALVOLINA

AÇO
PONTEIRA RIJA

1795.F5
500 GR

€ 24

1795.F10
1000 GR

€ 28



PISTOLA DIESEL
1770.DB1

60L/MINUTO
AUTOMÁTICO

€ 65

PISTOLA TRANSFEGA

1770.DD

120L/MINUTO
MANUAL

€ 37



easylub

BOMBA DE MASSA

12 KG
1.5 METROS

1797A

€ 91



16 KG
1.5 METROS

1797

€ 97

BOMBA DE MASSA

1798

MANUAL
COM RODAS
16 KG
2.5 METROS

€ 106



easylub

BOMBA DE OLEO

1795A

MANUAL
12 KG
1.5 METROS

€ 82



BOMBA DE OLEO

1796

MANUAL
COM RODAS
16 KG
2.5 METROS

€ 93



ACESSÓRIOS PARA LUBRIFICAÇÃO

NEBULIZADOR
PNEUMÁTICO

1920

24 LITROS
VALV. SEG. 8 BAR

€ 278



RECUPERADOR
ÓLEO - PNEUMÁTICO

1803.80

APARADOR 18 LTS
80 LITROS

€ 275



easylub

PUVERIZADOR DE
ESPUMA PNEUMÁTICO

1942

24 LITROS
VALV. SEG. 8 BAR

€ 299



PUVERIZADOR DE ESPUMA
PNEUMÁTICO

1940

23 LITROS
INOX
VALV. SEG. 8 BAR

€ 575



50 LITROS
VALV. SEG. 8 BAR

1943

€ 340

1940.50
50 LITROS
INOX
VALV. SEG. 8 BAR

€ 615

easylub



DISTRIBUIDOR DE ÓLEO

1770.0

€ 450



BOMBA ÓLEO PNEUMÁTICO

24 LITROS
1.5M

1910.N

€ 282

easylub

JARROS DOSEADORES

1L - 1770.01

€ 6,50

2L - 1770.02

€ 9,20

5L - 1770.05

€ 13,50



FUNIL ARTICULADO

G3190

€ 10,90

G3230

€ 15,50



JARROS DOSEADORES

1L - 1770.C01

€ 6,50

2L - 1770.C02

€ 7,60

3L - 1770.C03

€ 13,50





BACIAS DE RETENÇÃO

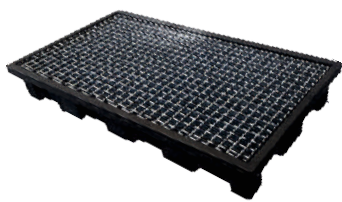

60 LITROS
1285 x 685 x 150 1BR60

€ 199



120 LITROS
1285 x 1285 x 150 1BR120

€ 469

CAIXA DE RETENÇÃO



PARA BATERIAS AUTO
780X480X600 1CBP

€ 229



PANO MULTIUSOS PARA DETAIL

410
PRODYLENE

TECIDO
NÃO TECIDO

€ 40,4

PANO BRANCO LIMPEZA
ROLO 115 METROS
50 GR - 25X38 CM
70% FIBRA 30% AGLUTINANTE



SUPOTE CHÃO

96 X 50 CM

605

€ 37



SUPOTE PAREDE

37 X 37 CM

610

€ 26



ROLO DE PAPEL
331BLU180



ROLO DE PAPEL
320180



PALETE - 120 ROLOS

PALETE - 120 ROLOS



PACK 2 UNIDADES
COR AZUL
3 FOLHAS
194 MTS LINEARES
24 X 38 CM FOLHA

€ 29,8



PACK 2 UNIDADES
COR BRANCO
3 FOLHAS
194 MTS LINEARES
24 X 38 CM FOLHA

€ 29,8



ABSORVENTE RÁPIDO

REUTILIZÁVEL ATÉ À SATURAÇÃO
 QUIMICAMENTE NEUTRO
 ABSORVE TODO O TIPO DE LÍQUIDOS
 RETARDANTE DE FOGO E PRODUTOS INERTES
 INDICADO PARA OFICINAS, INDÚSTRIA, HIDRÁULICA,
 GESTORES DE RESÍDUOS, MANUTENÇÃO DE
 ESTRADAS, AVIAÇÃO...



ABSORÇÃO DE ÁGUA - 110 %
 ABSORÇÃO DE ÓLEO - 70 %

absoal
 SEPIOLITA



S 15/30PP
 SACOS DE 20 KG

€ 14,60

CARCOOS



Rev. ✓
 12/2022

316
 MASSA DE JUNTAS
 -50° ATÉ 300°
 ALTA EFICIENCIA 90 GR

cx 30 un

€ 7,40



SHAMPOO NEUTRO

873

SHAMPOO NEUTRO
 LAVAGEM 20 LT

cx 1 un

€ 33,70



ANTICORROSÃO

869N

ANTI CORROSÃO
 RESINA E ZINCO
 400 ML

€ 6,80



HIGIENIZADOR

501

HIGIENIZADOR DE
 INTERIORES
 500 ML

€ 3,07



MASSA LAVAR MÃOS

851PL

5 KG
 CONCENTRADA
 PERFUMADA
 ALTAMENTE EFICAZ



€ 12,90



DETERGENTE LAVAGEM PAVIMENTOS

871

€ 68,90



SPRAYS DIVERSOS



GAMA DE PRODUTOS PROFISSIONAL PARA LIMPEZA E MANUTENÇÃO DE VEÍCULOS AUTOMÓVEIS

802
SPRAY REMOÇÃO
ALCATRÃO
400 ML



cx 24 un

€ 3,16

807/2
SPRAY LIMPEZA
DE TRAVÕES
500 ML



cx 12 un

€ 2,99



812NO-SIL
COCKPIT SPRAY
SEM SILICONE
500 ML



cx 24 un

€ 3,50

852
SPRAY LIMPEZA
VIDROS
400 ML



cx 24 un

€ 3,10

813
SPRAY HIGIENIZANTE
AR CONDICIONADO
200 ML



cx 24 un

€ 5,45

817
SPRAY SILICONE
400 ML



cx 24 un

€ 3,21

829F
SPRAY LUBRIFICANTE
500 ML



cx 12 un

€ 3,89

830
SPRAY RLUBRIFICADOR
DE CORRENTES
400 ML



cx 12 un

€ 4,70

804
SPRAY LIMPA
CARBURADORES
400 ML



cx 12 un

€ 4,80

300
SPRAY REMOVEDOR
ANTI-FERRUGEM
400 ML



cx 24 un

€ 2,84

301
SPRAY REMOVEDOR
SUPER ANTI-FERRUGEM
400 ML



cx 24 un

€ 3,60

400 S
SPRAY ZYNCO
96 % COR ESCURA
400 ML



cx 12 un

€ 5,03

865
TINTA PRETA PLÁSTICOS
EXTERIOR VIATURA
400 ML



cx 12 un

€ 5,03

866
TINTA CINZA PLÁSTICOS
EXTERIOR VIATURA
400 ML



cx 12 un

€ 5,03

410
SPRAY SOPRADOR
LIMPEZA DE COMPONENTES
ELETRÓNICOS - 400 ML



cx 12 un

€ 4,12

810
MASSA DE
ESCAPES
170 GR



cx 12 un

€ 3,50

817
SPRAY DESMOLDANTE
ANTI-GRAINHAS
SILICONE - 400 ML



cx 24 un

€ 3

315
MASSA DE JUNTAS
50 A 300°C
90 GR



cx 30 un

€ 3,53

400 C
SPRAY ZYNCO
96 % COR CLARA
400 ML



cx 12 un

€ 5,5

852
SPRAY LIMPA
VIDROS
400 ML



cx 24 un

€ 3,10

818
SPRAY VASELINA
400 ML



cx 24 un

€ 3,30





METALOMECÂNICA



GRANDINETTI

DISCO DE CORTE INOX BLUE LINE

112303 - 115x1,0x22
cx 100 un € 0,59

03030 - 125x1,0x22
cx 100 un € 0,68

114103 - 180x1,9x22 - 1.02
cx 50 un € 1,29

113803 - 230x1,9x22 - 1.62
cx 50 un € 1,75



DISCO DE CORTE FERRO

100702 - 115x3,2x22 BlueLine
cx 50 un € 0,69

101802 - 125x3,2x22 BlueLine
cx 50 un € 0,79

101502 - 180x3,2x22 BlueLine
cx 50 un € 1,09

102002 - 230x3,2x22 BlueLine
cx 50 un € 1,69



DISCO DE REBARBAR FERRO

100801 - 115x4.8x22 BlueLine
cx 50 un € 1,05

101801 - 180x6,4x22 BlueLine
cx 25 un € 1,79

101201 - 125x6.4x22 BlueLine
cx 50 un € 1,42

102401 - 230x6,4x22 BlueLine
cx 25 un € 3,35

DISCO DE CORTE INOX PREMIUM +30

115603 - 115x1,0x22
cx 100 un € 0,69

115803 - 125x1,0x22
cx 100 un € 0,79

DISCO DE CORTE PREMIUM +30

114802 - 115x3,2x22 - 1.02
cx 50 un € 0,79



DISCO LAMELADO INOX

GRANDINETTI

204104 - 115 - GRÃO 40 FIBRA
cx 25 un € 1,52

L125Z040TFP - 125 - GRÃO 40 CÓNICO
cx 20 un € 2,39

204204 - 115 - GRÃO 60 FIBRA
cx 25 un € 1,52

L125Z060TPF - 125 - GRÃO 60 CÓNICO
cx 20 un € 2,39

204304 - 115 - GRÃO 80 FIBRA
cx 25 un € 1,52

L125Z080TPF - 125 - GRÃO 80 CÓNICO
cx 20 un € 2,39

L115Z100TFC - 115 - GRÃO 100 FIBRA
cx 25 un € 1,52

L125Z100TFC - 125 - GRÃO 100 CÓNICO
cx 20 un € 2,39

200704 - 115 - GRÃO 120 FIBRA
cx 25 un € 1,52

L125Z100TFC - 125 - GRÃO 120 CÓNICO
cx 20 un € 2,39





**INVERTER
ECF-1400**

INVERTER
10-140 AMP
230 V - MMA E TIG
COM MALA,
ALICATE E CABO MASSA

S00173 € 298



**INVERTER
ECF-1700**

INVERTER C/ DISPLAY
10-160 AMP
230 V - MMA E TIG
COM MALA,
ALICATE E CABO MASSA

S00174 € 350



**INVERTER
ECF-2000**

INVERTER C/ DISPLAY
10-200 AMP
230 V - MMA E TIG
COM MALA,
ALICATE E CABO MASSA
60% 150 A

S00172 € 490



TOCHA TIG BINZEL 4MT
PARA ECF 1400 E ECF 1600
CONEXÃO - 25 MM

535710 € 210



TOCHA TIG SR17V
CONEXÃO - 50MM
PARA ECF-2000 E TIG 2022

535801 € 260



TIG 2022 DC HF

200 A - HOT START
SLOPE DOWN
2T / 4 T
7.3 KG - 230 V
25% - 200A
60% - 120A
100% - 100A

S00151 € 825

TOCHA BINZEL
ABITIG 26 V
PARA ECF-2000

535717 € 293





TIG 2005 AC / DC HF 200A

5 - 200A - TIG
 200 A - HOT START
 SLOPE DOWN
 2T / 4 T
 11.2 KG - 230 V
 EM AC FUNÇÃO DE LIMPEZA
 FREQUÊNCIA AJUSTÁVEL
 IDEAL PARA INOX, FERRO, AÇO
 TITÂNIO, ALUMÍNIO E MAGNÉSIO

PULSADO



TOCHA ABITIG 26
 4 MT
 PARA 2005 AC / DC HF
 TIG 30% - 200A | 60% - 140A |
 100% - 110A



S00161 € 1.810

535802 € 395



CONCEPT MIG 2000

BAIXO CONSUMO DE ENERGIA
 COM TOCHA M15 - 3 METROS

200 AMP
 30% - 200A | 60% - 155A | 100% - 140A
 MONOFÁSICA - 230 V
 AFINAÇÃO ELETRÓNICA
 CONTROLO SINÉRGICO
 4 ROLOS PUXA FIO
 FIO 0,6/0,8/0,9/1.0 FERRO E ALUMINIO
 PROGRAMAS Fe - Al - SS - CuSi
 EQUIPADO COM PROGRAMA ESPECIAL
 COM CURVAS KOP PARA CHAPA FINA
 DISPLAY LCD
 BOTÃO ÚNICO DE AFINAÇÃO

S00373 € 2.190



CONCEPT MIG 3000
 BAIXO CONSUMO DE ENERGIA
 COM TOCHA M25 - 3 METROS

200 AMP
 40% - 270A | 100% - 190A
 TRIFÁSICA - 400V
 AFINAÇÃO ELETRÓNICA
 CONTROLO SINÉRGICO
 4 ROLOS PUXA FIO
 PROGRAMAS Fe - Al - SS - CuSi
 EQUIPADO COM PROGRAMA ESPECIAL
 COM CURVAS KOP PARA CHAPA FINA
 DISPLAY LCD
 BOTÃO ÚNICO DE AFINAÇÃO



S00374 € 2.600





GRUPO
ARREFECEDOR 5 LT

560103 CU54H

€ 1.025

320 AMP
35% - 320A | 60% - 270A | 100% - 250A
TRIFÁSICA - 400V
AFINAÇÃO ELETRÓNICA
CONTROLO SINÉRGICO
4 ROLOS PUXA FIO
FIO DE 0.6 A 1.2MM FERRO, ALUMÍNIO E INOX
PROGRAMAS Fe - Al - SS - CuSi
EQUIPADO COM PROGRAMA ESPECIAL
COM CURVAS KOP PARA CHAPA FINA
DISPLAY LCD
BOTÃO ÚNICO DE AFINAÇÃO
PESO 42KG

CONCEPT MIG 3500
BAIXO CONSUMO DE ENERGIA

COM TOCHA M25 - 3 METROS M36
320 AMP

S00375 € 3.240

TOCHA M501 - 3 METROS
ARREFECIDA

535019 € 330



CONCEPT PROMIG 3600
COM CARRO

20-350 - 400 V
COM PUXA FIO 4 ROLETES
TOCHA 4 MTSM36
PROLONGADOR DE 4+1.5 MTS
E FLUXÓMETRO INCLUÍDOS
MÚLTIPLAS IMPEDÂNCIAS
PESO 58 KG
35% - 320A / 60% - 270A / 100% - 250A

320 AMP

S00304

€ 4.070



CONCEPT PROMIG 3600
COM CARRO E ARREFECEDOR DE ÁGUA

S00304
ARREFECEDOR ÁGUA

€ 5.600





COMBO HI-MIG 2010 200A

MIG - 30% 200A | 60% - 155A | 100% 140A
TIG - 30% 200A - |60% - 155A| 100% 140A
MMA - 40% 160A | 60% - 135A | 100% 120A
BOBINE DE FIO Ø200MM - 5KG
TIG PULSADO
PFC (Power Factor Correction)
NA FUNÇÃO MIG/MAG TEM O MODO
SINÉRGICO OU PULSADO
PARA FERRO, INOX, ALUMINIO,
BRASAGEM E ARAME FLUXADO
COM TOCHA M25 - 4 MTS
DISPLAY A CORES 4.3'

MIG/MAG, MMA E TIG LIFT

MIG SINÉRGICA
TIG LIFT PULSADO
MMA

CARRO OPCIONAL
DUPLO PULSADO OPCIONAL

PERFEITA PARA
ASSISTÊNCIAS
COM PASSWORD
PESO: 18 KG

540180

OPCIONAL DUPLO PULSADO

€ 390

S00218+535014 TOCHA



€ 2.450

S01705A.10

KIT SOLDADURA - MASCARA
CABO DE MASSA E ALICATE MMA 25MM

€ 126

535718

TOCHA ABITIG 26
4 MTS - EURO CONECTOR

€ 410



COMBO HI-MIG 3020 270 A

MIG/TIG - 40% 270A - 100% 200A
MMA - 40% 220A - 100% 180A
BOBINE DE FIO Ø200MM - 5KG
TIG PULSADO
PFC (Power Factor Correction)
DISPLAY A CORES 4.3"
NA FUNÇÃO MIG/MAG TEM O MODO
SINÉRGICO OU PULSADO
PARA FERRO, INOX, ALUMINIO,
BRASAGEM E ARAME FLUXADO

MIG SINÉRGICA
TIG LIFT PULSADO
MMA

PREPARADA PARA
GRUPO ARREFECEDOR

S01704A.10

KIT SOLDADURA - MASCARA
CABO DE MASSA E ALICATE MMA 35 MM

€ 180



PESO: 35 KG

535014

TOCHA M 25 4 MTS

€ 174

4 ROLETES

580007
CARRO

€ 450

560102

CU56H- GRUPO
ARREFECEDOR 5LTS

€ 1.300

535019

TOCHA ARREFECIDA
M501 - 3 MTS

€ 330

S00384

€ 3.360



540181

DUPLO PULSADO

€ 390

535718

TOCHA ABITIG 26
4 MTS - EURO CONECTOR

€ 460





MIG/TIG - 35% 320A - 100% 270A
 MMA - 50% 270A - 100% 230A
 BOBINE DE FIO Ø200MM - 5KG
 TIG PULSADO
 PFC (Power Factor Correction)
 NA FUNÇÃO MIG/MAG TEM O MODO
 SINÉRGICO OU PULSADO
 PARA FERRO, INOX, ALUMINIO,
 BRASAGEM E ARAME FLUXADO

MIG/MAG, MMA E TIG LIFT

COMBO HI-MIG 4020 320 A

PREPARADA PARA
 GRUPO ARREFECEDOR



560102

CU56A- GRUPO
 ARREFECEDOR 5LTS

€ 1.300

535020

TOCHA ARREFECIDA
 M501 - 4 MTS

€ 363

535718

TOCHA ABITIG 26
 4 MTS - EURO CONECTOR

€ 460

S00385

4 ROLETES

€ 4.100

S01704A.10

KIT SOLDADURA - MASCARA
 CABO DE MASSA E ALICATE MMA 35 MM

€ 180

535016

TOCHA M 36 4 MTS

€ 232

540181

DUPLO PULSADO

€ 390

580007
 CARRO

€ 450



PLASMA THUNDER CUT 50 COM KRT STARTING (45A)



400V
CORTE DE 15 MM A 22 MM
SEPARAÇÃO MAX 30 MM
TOCHA MANUAL ECF-121 6 MTS
5 BAR - 190 LTS/MIN
18 KG PESO



P00444



€ 2.720

PLASMA THUNDER CUT 70

380V
CORTE DE 19 MM A 25 MM
SEPARAÇÃO MAX 35 MM
TOCHA MANUAL ECF-121 6 MTS
5 BAR - 190 LTS/MIN
18 KG PESO

P00445

€ 2.950



PLASMA 30-16 PFC INVERTER

230V
CORTE ATÉ 12 MM
SEPARAÇÃO 16 MM
TOCHA MANUAL P25 - 4 MTS
4.5 BAR - 40 LTS/MIN
9.5 KG PESO

P00479

€ 1.420



PLASMA 36 COMPRESSOR INVERTER PFC

230V
CORTE ATÉ 12MM
SEPARAÇÃO 16 MM
TOCHA MANUAL P25 4 MTS
COMPRESSOR INCORPORADO
16 KG PESO

P00481

€ 1.730



PLASMA 51 PFC INVERTER

SYNERGIC
PLASMA



400V
CORTE DE 13 MM A 20 MM
SEPARAÇÃO MAX 25 MM
TOCHA MANUAL ECF-71 6 MTS
5 BAR - 170 LT/MIN
18 KG PESO

P00482

€ 2.460



PLASMA 735 LCD INVERTER

400V
CORTE DE 19 MM A 25 MM
SEPARAÇÃO MAX 35 MM
TOCHA MANUAL ECF-71 6 MTS
5 BAR - 190 LTS/MIN
22 KG PESO
APTO PARA CNC

P00455

€ 3.550



CARACTERÍSTICAS GERAIS DE PLASMAS DA ELECTRO CF

- ARCO PILOTO PARA CORTAR METAIS PINTADOS OU REVESTIDOS. - PÓS-GÁS.
- SISTEMAS DE SEGURANÇA SOBRE A TOCHA. - CONTROLO DA PRESENÇA DE PRESSÃO DE AR COMPRIMIDO.
- TECNOLOGIA DE ULTRA CORTE DE CAPACIDADE PARA MELHORAR AS CAPACIDADES DE CORTE EM ESPESURAS ELEVADAS.
- TECNOLOGIA INOVADORA DE CORTE FINO QUE PERMITE OBTER CORTES DE QUALIDADE SUPERIOR E REDUÇÃO DO CORTE (QUANTIDADE DE MATERIAL REMOVIDO). - TECNOLOGIA HYPER SPEED CUT, QUE AUMENTA A VELOCIDADE DE CORTE.
- TECNOLOGIA MULTI PIERCING: POSSIBILIDADE DE PERFURAÇÃO EM ESPESURAS ELEVADAS NUM TEMPO MAIS CURTO E COM MENOR DESGASTE DOS CONSUMÍVEIS. - TECNOLOGIA EXTRA LIFE E TECNOLOGIA LOW PILOT ARC QUE AUMENTA OS DESEMPENHOS E A DURAÇÃO DOS CONSUMÍVEIS.
- TECNOLOGIA DE PONTA LONGA QUE PERMITE CORTAR PRÓXIMO DE ÂNGULOS MUITO ESTREITOS E ESPAÇOS PEQUENOS.
- PARÂMETROS E FUNÇÕES DE CORTE CONTROLADOS POR MICROPROCESSADOR. - SISTEMAS DE SEGURANÇA NA TOCHA.

**AVISO
IMPORTANTE**
LEIA COM ATENÇÃO

SOLDADURA POR PONTOS COM BRAÇO OSCILANTE



COM PEDAL PNEUMÁTICO BSM RF
 20 kVA A 50% DE POTÊNCIA
 11.5 kA MAX CORRENTE
 9.2 kA CORRENTE MAX DE SOLDADURA
 FORÇA DO ELETRODO 6 bar
 300 MM DE PROFUNDIDADE ÚTIL
 TRIFÁSICA 400V - 50HZ - 32A
 ROBUSTA, TERMOSTATO DE SEGURANÇA
 CONTROLO SCR SINCRONO
 BRAÇOS AJUSTÁVEIS EM PROFUNDIDADE
 PREPARADA PARA ARREFECIMENTO A ÁGUA
 DIAMETRO DO BRAÇO Ø45 - ABERTURA ELETRODOS 6-50

ZC1131
 BSP221RFS2

€ 3.150

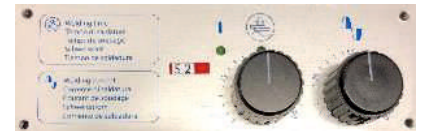

CONTROLADOR S2

OPCIONAIS:

GRUPO ARREFECEDOR

PAR DE BRAÇOS STANDARD ARREFECEDOR ÁGUA Ø45 MM

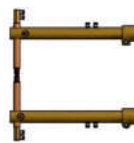

XBCC180 - CB80 PAR DE BRAÇOS Ø45X500MM
 COM ELETRODO Ø20X185

€ 519



XBCC190 - CB90 PAR DE BRAÇOS Ø45X700MM
 COM ELETRODO Ø20X185

€ 613

XAE037 - GRUPO ARREFECEDOR
 2 LP 380V

€ 1.000

PAR DE BRAÇOS REFRIGERADO A ÁGUA Ø45MM COM
 BRAÇO INFERIOR DE TAMANHO REDUZIDO 410-700 MM

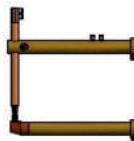

XBCC210 - CB90TTD - BSP - PAR DE BRAÇOS
 AJUSTÁVEIS Ø45X700MM

€ 797

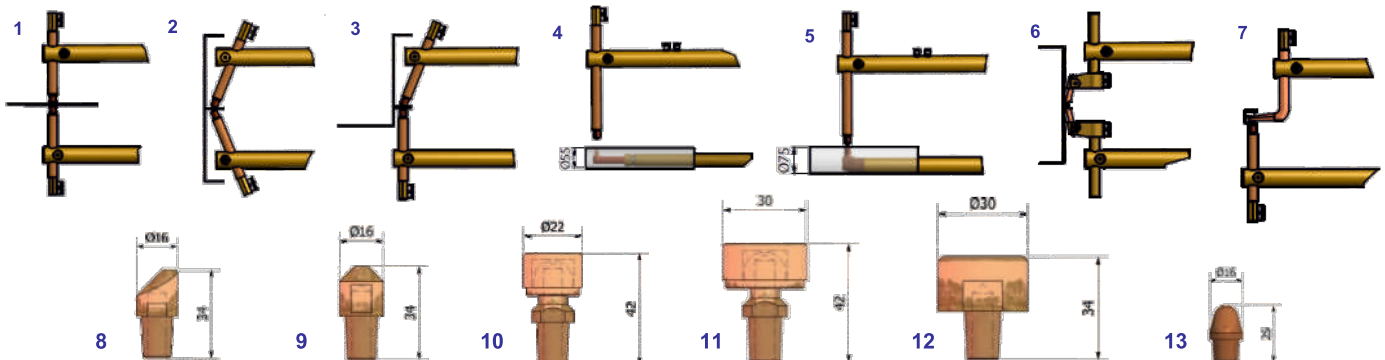

MANÓMETROS E MAÇARICOS



DEBITÓMETRO + FLUXOMETRO

25450 € 80



DEBITÓMETRO CO2

25500 € 68



MANOREDUTOR OXIGÉNIO

25000 € 68



DEBITÓMETRO CO2

25550 € 45



DEBITÓMETRO AZOTO

25400 € 68

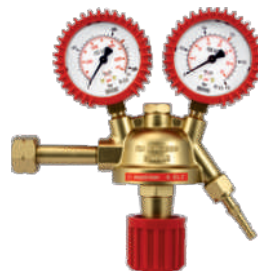

MANOREDUTOR ACETILENO

25100 € 68



DEBITÓMETRO
HIDROGÉNIO

25250 € 115



MAÇARICO CORTE

19520 € 135



ESTRELA DE 6 BICOS

10500/A € 15

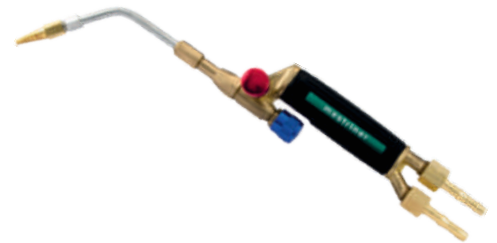

MAÇARICO SOLDAR
ESTRELA DE BICOS INCLUIDA

10400/A € 64



CUNHO PARA ESTANHAR
VULCANO

43221304 € 15,33



PUNHO + LANÇA
VULCANO

43221104 +
43221144 € 13,20



CAMPANULAS
VULCANO

43221224 - 45MM € 7,14

43221234 - 60 MM € 8,58



CONSUMÍVEIS DE SOLDADURA



2 METROS
16MM2
180 AMP
DA 25MM2
43210138K



€ 25

2 METROS
25MM2
300 AMP
DA 50MM2
43210170K



€ 39

3 METROS
35MM2
400 AMP
DA 50MM2
43210142K



€ 68



TOCHA SUNWELD XL15AK 12mm²

XL15AK3
3 MTS

€ 37

XL15AK4
4 MTS

€ 45



TOCHA SUNWELD XL36KD 35mm²

XL36KD3
3 MTS

€ 86

XL36KD4
4 MTS

€ 98

XL36KD5
5 MTS

€ 116

TOCHA SUNWELD XL25AK 18mm²

XL25AK3
3 MTS

€ 60

XL25AK4
4 MTS

€ 67

XL25AK5
5 MTS

€ 76



TOCHA ARREFECIDA 4MTS SUNWELD
XL501D

€ 149



BICO COBRE M6

340P081073
0.8 MM L-25MM ECU

€ 0,35

340P101073
1 MM L-25MM ECU

€ 0,36

340P121073
1.2 MM L-25MM ECU

€ 0,36

BICO COBRE M6

340P081069
0.8 MM L-28 MM

€ 0,48

340P101069
1 MM L-28 MM

€ 0,48

BICO COBRE M8

340P081262
0.8 MM L-30 MM

€ 0,65

340P101262
1 MM L-30 MM

€ 0,65



DIFUSOR DE GÁS

114P102004
BRANCO TOCHA 360

€ 0,95



SUPORTE CONTACTO

342P006003
M6 L35 TOCHA 250

€ 1,25

342P006014
M6 L 28 TOCHA 360

€ 1,25



BOCAL CILINDRICO

345P312003
DIAM. 15 BASIC 250

€ 3,4

345P312010
DIAM. 16 BASIC 360

€ 4,5



EQUIPAMENTOS DE PROTEÇÃO INDIVIDUAL



MÁSCARA DE SOLDAR 420

REACÇÃO 0.1 MS
RETORNO 0.4 MS
DETETORES LUZ 2 CIN19C

€ 43,50

BANDA ANTI-TRANSPIRAÇÃO MÁSCARA 420
2151002100000

€ 0,13



WISEIRA DE PROTEÇÃO 424RN

GRAU 5 PARA OXICORTE
CLASSE ÓTICA 2
320 X 190 MM
EN 169 | EN 175

€ 12,40



STORM VISION 4.1 LINHA PROFISSIONAL 99900269

CLASSE 1/1/1/1
DIMENSÃO DO FILTRO 133X114X9MM
GRAUS DE ESCURECIMENTO 5-8 / 9-13
VARIÁVEL
PROTEÇÃO UV DIN16
RAPIDEZ DE DISPARO 1/25000 SEG.
TEMPO DE OFF 0.05-1.0 SEG.
SENSIBILIDADE 10 NÍVEIS
BATERIA 9 HORAS
EFICIÊNCIA DO FILTRO 99.97%
2 NÍVEIS DE FLUXO DE AR

€ 1.150



ÓCULOS PROTECÇÃO OXICORTE 620

CLASSE ÓTICA 1
VIDRO 3 MM ESPESSURA
TONS DISPONÍVEIS - 4/6

€ 4,40



AURICULARES DE PROTEÇÃO CLIMAX 13

ESPUMA DE PU
DESCARTÁVEIS
SNR = 38 dB

€ 0,25



LUVAS PROTEÇÃO 301

NIVEL 4 - ESP. 1.7 MM
TAMANHO ÚNICO
EN 388 - EN 420

€ 5,10



LUVAS TIG 21905133

EM PELE
TAMANHOS 9 E 10
EN 388:2016
EN 407:2004
EN 420:2003 + A1:2009
EN 12477:2001+2005

€ 10,20



MANGUITOS PROTEÇÃO MANGUITOS 8

CLASSE PROTECÇÃO 2 A1+A2
COURO DE VACA
AJUSTE EM VELCRO

€ 11,06



PROTEÇÃO BOTAS OXICORTE POLAINAS 9

CLASSE PROTECÇÃO 2 A1+A2
COURO DE VACA
AJUSTE EM VELCRO

€ 10,80



CONSUMÍVEIS DE SOLDADURA



MÁSCARA DE PROTEÇÃO
1710

FFP1
IDEAL PARA CONSTRUÇÃO, POEIRAS
ÓXIDOS, NÉVOA E FUMOS
BANDAS DE AJUSTE SINTÉTICAS
8-10 HORAS USO
CAIXA COM 20 UNIDADES

€ 0,60



MÁSCARA DE PROTEÇÃO
1720 CARVÃO ACTIVO

FFP2 - CARVÃO ATIVO COM VÁLVULA
IDEAL PARA SOLDADURA, FUMOS E
ODORES GRAÇAS AO CARVÃO ATIVADO
RESISTÊNCIA RESPIRATÓRIA BAIXA
8-10 HORAS USO CLIP NASAL AJUSTÁVEL
CAIXA COM 12 UNIDADES

€ 1,89 235372020000



MÁSCARA PARA PINTURA
BORRACHA TERMOPLÁSTICA
A1BIE1K1P3

€ 19,90



MÁSCARA 760/761 A1

MÁSCARA P/ GASES, VAPORES OU PARTÍCULAS
PVC SEM FORRO
FATOR PROTEÇÃO 50

€ 6,03

VIDRO DE MÁSCARA 110X60MM DN 10 - 0,19 €
VIDRO DE MÁSCARA 110X50 T.11 - 0,18 €
VIDRO DE MÁSCARA 105X50 T.11 - 0,18 €

CAPACETE DE PROTEÇÃO
5 RS



€ 1,39



SEMI MÁSCARA FLÉXIVEL

MÁSCARA EM BORRACHA NATURAL
COMPATIVEL COM FILTROS 755/756
FATOR PROTEÇÃO 50
AMBIENTES POLUÍDOS E C/ CONTEÚDO
OXIGÉRNIO SUPERIOR A 195%
PURIFICA O AR EXISTENTE

756 P3 € 16,50

756 BIE1 € 15,90

ÓCULOS DE PROTEÇÃO
569-I



POLICARBONATO
EN 166:2001 EN 170:2002
TAMANHO ÚNICO

€ 2,30

ÓCULOS DE PROTEÇÃO
590-I



POLICARBONATO
EN 166:2001 EN 170:2002
TAMANHO ÚNICO

€ 2,06

MASCARA DE PROTEÇÃO
761 A1



NPF 50 - PESO 150GR
AJUSTÁVEL
FILTROS 760

€ 13,15

ABAFADORES
CLIMAX 10



HIPOALERGÉNICO
TAMANHO S, L, M
EN 352-1 CE

€ 6,40



SERROTES DE DISCO



FITAS DE SERRA WALZER M42 SIMPLEX

- 1440X13X0.65 Z10/14 - LAM144013WZ1014 - 38 €
- 1440X13X0.65 Z8/12 - LAM144013WZ812 - 38 €
- 1735X13X0.65 Z10/14 - LAM173513WZ1014 - 42 €
- 1735X13X0.65 Z8/12 - LAM173513WZ812 - 42 €
- 2085X20X0.9 Z10/14 - LAM208520WZ1014 - 47.5 €
- 2085X20X0.9 Z6/10 - LAM208520WZ610 - 47.5 €
- 2450X25X0.9 Z10/14 - LAM245025WZ1014 - 55.0 €
- 2450X25X0.9 Z6/10 - LAM245025WZ610 - 55.0 €
- 2750X27X0.9 Z5/8 - LAM275027WZ58 - 60 €
- 2750X27X0.9 Z6/10 - LAM275027WZ610 - 60 €
- 3240X27X0.9 Z4/6 - LAM3240027WZ46 - 40.90€



TPI Selection Round Solid Metals

Teeth Per Inch (TPI)

24	14	10/14	8/12	6/10	5/8	4/6	3/4	2/3	1.1/1.5
----	----	-------	------	------	-----	-----	-----	-----	---------

Material Thickness

mm	2	7	10	15	20	25	50	127	254
inch	0.08	0.3	0.4	0.6	0.8	1.0	2.0	5.0	10.0

TPI Selection Tube/Pipe/Profile Metal Section

Teeth Per Inch (TPI)

14	10/14	8/12	6/10	5/8	4/6	3/4	2/3	1.1/1.5
----	-------	------	------	-----	-----	-----	-----	---------

Material Thickness

mm	2	2.5	4	5	7	15	27	50
inch	0.08	0.1	0.15	0.2	0.3	0.6	1.06	2.0

FOLHAS PARA SERROTES DE FITA
VÁRIOS TAMANHOS E VÁRIOS TIPOS DE DENTE



SERROTE DE DISCO

SERRA CIRCULAR MANUAL DE ESQUADRIA DUPLA
DISCO DE LÂMINA 250 MM.
CORTE DE ESQUADRIA BIDIRECIONAL (DE 0 ° A 45 ° À ESQUERDA E À DIREITA).
TORNO DE BLOQUEIO RÁPIDO COM FIXAÇÃO ANTI-REBARBAS.

AAS60000-3

€ 1.990

250 TECHNICS 380 V
2 VELOCIDADES DE CORTE

AAS60000-1

€ 2.020

250 TECHNICS 220 V
1 VELOCIDADE DE CORTE

TABELA DE CORTE

	○	□	▭	●
0 °	75	65	90 x 50	40
<45 °	60	60	60 x 50	35
45 °>	60	60	60 x 50	35



SERROTE DE DISCO

SERRA CIRCULAR MANUAL DE ESQUADRIA DUPLA
DISCO DE LÂMINA 315 MM.
CORTE DE ESQUADRIA BIDIRECIONAL (DE 0 ° A 45 ° À ESQUERDA E À DIREITA).
TORNO DE BLOQUEIO RÁPIDO COM FIXAÇÃO ANTI-REBARBAS.

AAL30000-3

€ 3.370

SUPERCUTS315
380 V

TABELA DE CORTE

	○	□	▭	●
0 °	95	80	100 x 70	80
<45 °	90	75	80 x 70	70
45 °>	90	75	80 x 70	70





DESCIDA ASSISTIDA POR CILINDRO HIDRÁULICO
 380 V - DUAS VELOCIDADES
 INTERRUPTOR NO PUNHO
 FITA DE SERRA BIMETÁLICA 2085X20X0,9
 ESCALA MILIMÉTRICA
 0 A 60° À DIREITA
 BOMBA DE CIRCULAÇÃO DE LIQUIDO REFRIGERANTE

SERROTE DE FITA



TABELA DE CORTE

	0°	45°	60°
	180	120	50
	180	110	50
	200x150	120x110	50x70

ZIP 22 HB 380V
 AAT40000-3

€ 2.960



DESCIDA ASSISTIDA POR CILINDRO HIDRÁULICO
 380 V - DUAS VELOCIDADES
 INTERRUPTOR NO PUNHO
 FITA DE SERRA BIMETÁLICA 2450x27x0,9
 ESCALA MILIMÉTRICA
 0 A 60° À DIREITA
 BOMBA DE CIRCULAÇÃO DE LIQUIDO REFRIGERANTE

SERROTE DE FITA



TABELA DE CORTE

	45°	0°	45°	60°
	120	225	140	60
	120	200	140	60
	110x140	240x140	135x150	60x85

ZIP 31 DA 380v

€ 4.790

AAV90000-3



	0°	45°	60°
	225	140	60
	200	140	60
	240x140	135x150	60x85

ZIP 30 DA 380v

€ 3.670

AAZ10000-3

DESCIDA ASSISTIDA POR CILINDRO HIDRÁULICO
 380 V - DUAS VELOCIDADES
 INTERRUPTOR NO PUNHO
 FITA DE SERRA BIMETÁLICA 2750x27x0,9
 ESCALA MILIMÉTRICA
 0 A 60° À DIREITA
 BOMBA DE CIRCULAÇÃO DE LIQUIDO REFRIGERANTE

SERROTE DE FITA



TABELA DE CORTE

	45°	0°	45°	60°
	160	255	200	110
	160	250	190	110
	190x100	300x220	190x170	110x130

ZIP 32 DA 380V

€ 6.350

Código: AAV70000-3





ESPERA DE SAÍDA

AAR 5100G € 1.390

AAR 5100GH € 1.980

COM ESPERA DE ENTRADA,
MEDIDORELÉTRONICO E BAR STOP



ATÉ 250 KG
COMPRIMENTO 2 MT
PARA SUPERTRAD 301
PARA LINHA 380

SERROTE DE FITA AUTOMÁTICO

DESCIDA ASSISTIDA POR CILINDRO HIDRÁULICO
380 V - DUAS VELOCIDADES
INTERRUPTOR NO PUNHO
FITA DE SERRA BIMETÁLICA M42 3310x27x0,9 MM
ESCALA MILIMÉTRICA



340 mm

SUPERTRAD 380
MULTIMODE AAS80000-3

€ 14.800

TABELA DE CORTE

45°	0°	45°	60°
220	300	260	180
180	260	250	170
200x160	330x260	270x200	170x170



SERROTE DE FITA AUTOMÁTICO



DESCIDA ASSISTIDA POR CILINDRO HIDRÁULICO
VELOCIDADE DA LÂMINA INFINITAMENTE VARIÁVEL
ATRAVÉS DE INVERTER DE 20 A 105 M/MIN
CICLO COMPLETO DE CORTE SEM OPERADOR
380 V - DUAS VELOCIDADES
INTERRUPTOR NO PUNHO
SERRA BIMETÁLICA M42
3310x27x0,9 MM
ESCALA MILIMÉTRICA
TOUCH SCREEN
AUTO-DIAGNÓSTICO



340 mm

SUPERTRAD 380
SO EASY AAV30000-3

€ 16.760



ESPERA DE SAÍDA

AAR 5100G € 1.390

AAR 5100GH € 1.980

COM ESPERA DE ENTRADA,
MEDIDORELÉTRONICO E BAR STOP

45°	0°	45°	60°
220	300	260	180
180	260	250	170
200x160	330x260	270x200	170x170



SERROTE DE FITA AUTOMÁTICO



THOMAS SUPER TRAD 370 AO CN EVOLUTION AAT10000-3

MÁQUINA DE SERRA DE FITA HORIZONTAL POTENTE IDEAL PARA USO INTENSIVO REGULAR EM METAIS MAIS DUROS, COMO FERRO E AÇO. AUTOMÁTICA.
CORTE DE ESQUADRIA SIMPLES 60° À DIREITA.
VELOCIDADE INFINITAMENTE VARIÁVEL DA LÂMINA ATRAVÉS DO INVERSOR DE 20 A 105 M / MIN
CONTROLADOR TOUCH SCREEN COM CONTADOR DE PEÇAS E HORAS DE TRABALHO.
EXIBIÇÃO DA VELOCIDADE DE ROTAÇÃO DA LÂMINA (COM OPÇÃO INVERTER)
INTERFACE APP PARA TELEMÓVEL
FOLHA BIMETÁLICA M42 3240x27x0.91

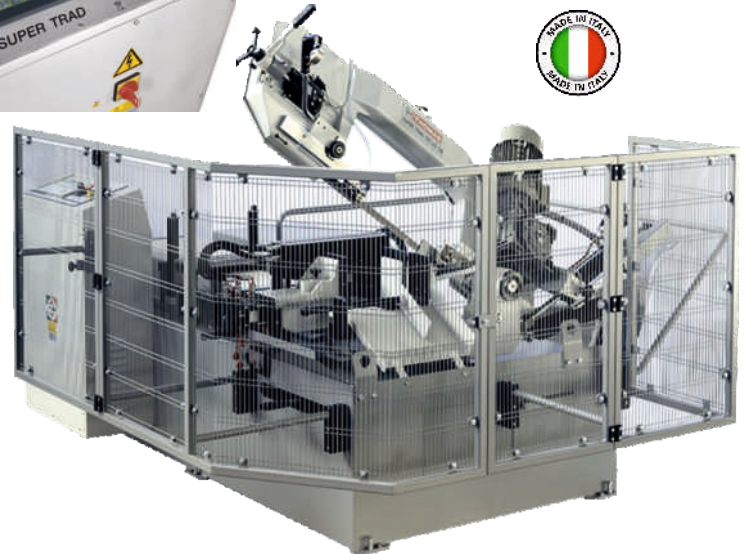

€ 34.400

TABELA DE CORTE

	0°	45°	60°	
	300	270	170	355 mm
	260	260	150	
	350x260	270x200	170x150	



THOMAS SAR 480 SA GDS

MÁQUINA DE CORTE DE ALTA PERFORMANCE HIDRÁULICO DE SUBIDA E DESCIDA
VELOCIDADE DE CORTE VARIÁVEL DE 20 A 105 M/MIN
LÂMINA BI METÁLICA M42 3810X28X0.9.
CORTE DE ESQUADRIA SIMPLES DE 0 60° À ESQUERDA E 0 A 45° À DIREITA.
TENSÃO MECÂNICA DA LÂMINA
BOMBA ELÉCTRICA DE REFRIGERAÇÃO
BATENTE DE MEDIÇÃO
PARAGEM AUTOMÁTICA DO MOTOR NO FINAL DO CORTE
ABERTURA E FECHO AUTOMÁTICOS (OPCIONAL)



€ 18.230

AAM60000-3

	60°	45°	0°	45°	
	200	300	330	310	485 mm
	200	280	330	280	
	200x200	290x250	480x130	280x250	



SERROTE DE FITA AUTOMÁTICO

SAR 610 SA DIGIT
AAM70000-3

€ 33.200

ESTRUTURA REFORÇADA EM AÇO, TOUCH SCREEN
HIDRÁULICO DE SUBIDA E DESCIDA
REGULADOR HIDRÁULICO PARA VELOCIDADE DE DESCIDA
VELOCIDADE DE CORTE VARIÁVEL DE 20 A 105 M/MIN
TECNOLOGIA INVERTER, CONTADOR DE PEÇAS
AJUSTE DA ALTURA DE CORTE, AUTO DIAGNÓSTICO
LAMINA BI METÁLICA M42
TENSÃO DA FOLHA COM MANÓMETRO
BOMBA ELÉCTRICA DE REFRIGERAÇÃO



5650x34x1,1



TABELA DE CORTE

	60°	45°	0°	45°	60°
	340	500	500	500	340
	320	450	500	450	320
	340x275	500x300	610x500	500x300	340x275



STH 1	0°	45°	60°
	122	95	63
	122	95	63
	122x122	95x95	63x63
	1440x13x0,65	1,3	30/80
			21 Kg

OPTIONAL
AAU60000-1

€ 785



STH 2	0°	45°	60°
	150	90	65
	140	90	65
	150x140	100x90	65x70
	1735x13x0,65	1,8-2,0	30/63
			27 Kg

OPTIONAL
AAU70000-1



€ 1150





COLUNA ALTA

MOTOR 0.5 HP
ALIMENTAÇÃO 380V
BUCHA 16 MM
COLUNA D. 73 MM
VELOCIDADE – 180-2740 RPM
ENCAVADOR MT2
ALTURA 1620 MM
PESO 57 KG

DP34016F € 380

MEIA COLUNA

MOTOR 0.5 HP
ALIMENTAÇÃO 220V
BUCHA 16 MM
COLUNA D. 73 MM
VELOCIDADE – 180-2740 RPM
ENCAVADOR MT2
ALTURA 1080 MM
PESO 52 KG

DP34016B € 299



COLUNA ALTA

MOTOR 1.5 HP
ALIMENTAÇÃO 380V
BUCHA 25 MM
COLUNA D. 92 MM
VELOCIDADE – 120-3480 RPM
ENCAVADOR MT2
ALTURA 1640 MM
PESO 144 KG

DP51025F € 830



MODELO ZS40PS ENGENHO SEM MESA DE FRESAGEM E SEM DESCIDA AUTOMÁTICA

ZS40PS € 3.100



MESA DE FRESAR

ZX7025A € 455

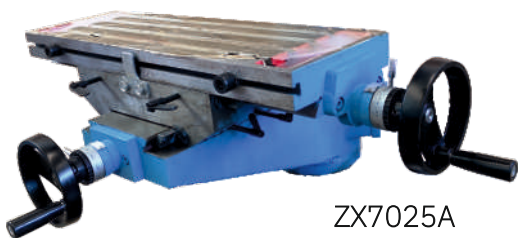

MESA MARCA BEERGMAN
MEDIDA DA MESA - 640X205
DESLOCAMENTO. LONGITUDINAL 370 MM
DESLOCAMENTO TRANSVERSAL 150 MM
DIMENSÕES BASE (MM) 238X320
PESO (KGS) 60

ENGENHO COM MESA E REGRIGERAÇÃO

MEDIDA MESA FRESAR 585X190
MOTOR (HP) 1
Nº VELOCIDADES FURAÇÃO 6-95~1600
CAPACIDADE FURO 40 MM
Ø COLUNA 115 MM
DISTÂNCIA PONTO BASE 1245 MM
ALTURA (MM) 1810
PESO (KGS) 375
COM DESCIDA E RECUO AUTOMÁTICO

ZX40BPC € 3.490





TORNOS DE BANCADA



FZA MONDIAL

M/90 - 100 MM € 118

M/91 - 125 MM € 133

M/92 - 150 MM € 190

M/93 - 175 MM € 285



Cod.	Larghezza ganasce Largeur des mâchoires Jaws width Backenbreite Anchura de boca	Apertura Ouverture Opening Spannweite Apertura	⚖ Kg
M/90	100	125	7,0
M/91	125	150	11,0
M/92	150	200	17,0
M/93	175	220	26,0



S-125* € 210

S-200 M € 360

S-150* € 248

S-200 T € 399

SEM VIBRAÇÃO - PROTEÇÃO TÉRMICA
ATÉ DEZ ANOS DE GARANTIA



Art.	HP	W	RPM	MOLA	PESO NETTO	PESO LORDO Bancale	DIMENSIONI cm	
S-125*	0,35	1~	260	2800	125X16X20	7,1	8,1	32X22X26
S-150*	0,50	1~	375	2800	150X20X20	9,3	10,3	35x23x29
S-200M	0,90	1~	675	2800	200x25x16/20	17,6	18,6	45x30x34
S-200T	1,00	3~	750	2800	200x25x16/20	17,6	18,6	45x30x34



Art.	Posizione spazzola	HP	W	RPM	Spazzola mm	Mole mm	PESO NETTO	PESO LORDO Bancale	dimens. cm	
CE-2	DX SX	1,00	3~	750	2800	200x25x20	200X25X20	18,9	19,9	65X29X36

CE-2 - 380V € 490



ACESSÓRIOS PARA METALOMECÂNICA

VESPA
SABBIATRICI



VESPA

VSA/C24 - 5MT TUBO ABRASIVO Ø 25
PORTA BICO - PORTA BORRACHA
BICO DE CARBONETO EM TUNGSTÊNIO Ø 4 x 40

206.024 - 24 LITROS € 1.890

VSA/C80 (10 MTS TUBO) OU VSA/C200 (20 MTS TUBO)
ABRASIVO Ø 40 - PORTA BICO - PORTA BORRACHA
BICO DE CARBONETO EM TUNGSTÊNIO Ø 7 x 75 OU Ø 8 x 75

206.080 - 80 LITROS € 3.380

206.200 - 200 LITROS € 4.116

VESPA
SABBIATRICI

PANDA



DECAPAGEM DE BAIXA PRESSÃO - 24 LITROS
IDEAL PARA RESTAUROS

MANGUEIRA DE ABRASIVO Ø 25, 5 METROS COM PORTA-MANGUEIRA
PORTA-BICO COM PORCA DE ANEL E BICO DE TUNGSTÊNIO Ø 4 X 40.
1,5 A 12 BAR - FUNCIONA COM DIVERSOS TIPOS DE ABRASIVO:
MICROESFERAS DE VIDRO, BICARBONATO DE SÓDIO PARA REMOÇÃO
DE TINTAS E LIMPEZA, ABRASIVOS VEGETAIS (CASCA DE NOZ
MOÍDA, SABUGO), AREIA DE SÍLICA (NÃO PERMITIDA EM EDIFÍCIOS
PÚBLICOS) E GRÃOS DE METAL

205-102 PANDA/C 24 € 3.350

CAPACETE PROTEÇÃO VRC 4



300010 € 199

VESPA
SABBIATRICI

PROTECÇÃO DO OPERADOR



300040

€ 590

CAPACETE C/FATO
VESPA VACS 952

CAPACETE C/FATO
VESPA VACS 951

300030

€ 568





PUNÇONADORA UNIVERSAL



MAIS PRODUTIVIDADE COM DISTÂNCIA AJUSTÁVEL DO CURSO DO PISTÃO
SISTEMA DE LUBRIFICAÇÃO CENTRAL
CINCO ESTAÇÕES DE TRABALHO INDIVIDUAIS NA MÁQUINA
PUNÇÃO E MATRIZ DE Ø22 MM E FERRAMENTAS PERFURADORAS PADRÃO
CONJUNTO DE LÂMINAS DE CORTE DE BARRAS REDONDAS E QUADRADAS
CONJUNTO DE LÂMINAS DE CORTE ANGULAR
TESOURA DE CORTE DE CHAPA
CONJUNTO DE LÂMINAS U-NOTCHING
60 TON

HKM 60

€ 11.900

INCLUI 6 PUNÇÃO + MATRIZES REDONDAS
EM MEDIDAS A ESCOLHER ATÉ 22 MM



PUNÇONADORA UNIVERSAL DUPLO PISTON
2 POSTOS DE TRABALHO

MAIS PRODUTIVIDADE COM DISTÂNCIA AJUSTÁVEL DO CURSO DO PISTÃO
SISTEMA DE LUBRIFICAÇÃO CENTRAL
CINCO ESTAÇÕES DE TRABALHO INDIVIDUAIS NA MÁQUINA
PUNÇÃO E MATRIZ DE Ø22 MM E FERRAMENTAS PERFURADORAS PADRÃO
CONJUNTO DE LÂMINAS DE CORTE DE BARRAS REDONDAS E QUADRADAS
CONJUNTO DE LÂMINAS DE CORTE ANGULAR
TESOURA DE CORTE DE CHAPA
CONJUNTO DE LÂMINAS U-NOTCHING
85 TON

HKM 85

€ 24.990

INCLUI 6 PUNÇÃO + MATRIZES REDONDAS
EM MEDIDAS A ESCOLHER ATÉ 22 MM

CU 500

MOTOR COM 7.5 KW
 BUCHA COM Ø 656
 BUCHA COM 3 GRAMPOS 250 MM
 LUNETETA FIXA COM ROLETES 15-160 MM
 LUNETETA MÓVEL 15-200 MM
 PONTO ROTATIVO
 TORRETA RÁPIDA TIPO C
 PEDAL DE EMERGÊNCIA
 FURO ÁRVORE 62 MM
 21 VELOCIDADES

OPCIONAIS:

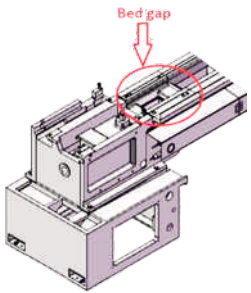
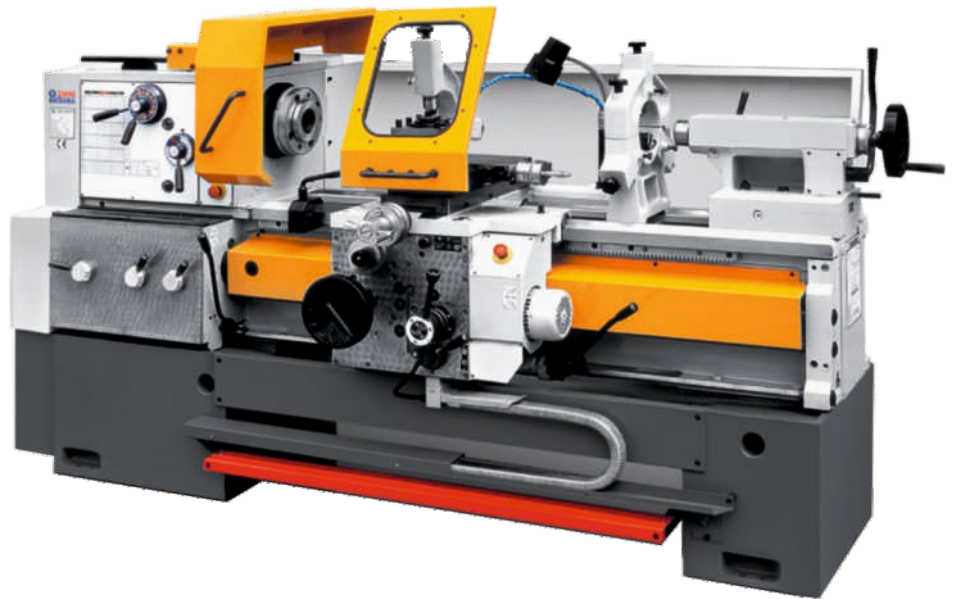

BARRAMENTO
 DESTACÁVEL

€ 1.200

ACESSÓRIO PARA
 PEÇAS CÔNICAS +10°

€ 1.196



CU 500 - 1.5 MTS € 38.890

CU 500 - 2 MTS € 39.710

MOTOR COM 7.5 KW
 BUCHA 3 GRAMPOS 250 MM, LUNETETA FIXA
 LUNETETA MÓVEL 15-200 MM
 LUNETETA FIXA COM
 ROLETES 15-160 MM
 PONTO ROTATIVO
 TORRETA RÁPIDA TIPO B
 PEDAL DE EMERGÊNCIA
 FURO ÁRVORE 80 MM
 21 VELOCIDADES

CU 580



OPCIONAIS:

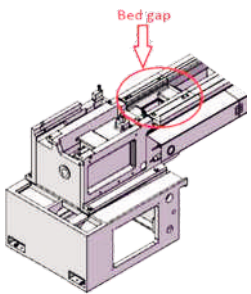

BARRAMENTO
 DESTACÁVEL

€ 1.466

ACESSÓRIO PARA
 PEÇAS CÔNICAS +10°

€ 1.196



CU 580 M - 1.5 MTS € 41.460

CU 580 M - 2 MTS € 42.260

CU 580 M - 3 MTS € 44.290



CU 630



MOTOR 11KW
3 GRAMPOS 315 MM, LUNETTA FIXA
LUNETTA MÓVEL, PONTO ROTATIVO
TORRETA RÁPIDA TIPO C
PEDAL DE EMERGÊNCIA
FURO ÁRVORE 103 MM

OPCIONAIS:

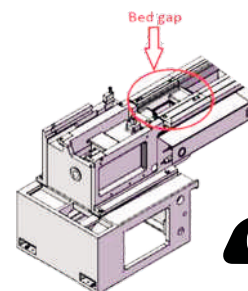

BARRAMENTO
DESTACÁVEL

€ 1.466



ACESSÓRIO PARA
PEÇAS CÔNICAS +10°

€ 1.196

CU 630 - 3 MTS

€ 53.150



ARRANQUE ELETRICO
CAIXA NORTON AUTOMÁTICA
FREIO ELÉTRICO
PRATO 3 GARRAS UNIVERSAL Ø 250MM
PRATO 4 GARRAS INDEPENDENTE Ø 320MM
PRATO LISO Ø 410MM
VISUALIZADOR FAGOR XY
PONTO GIRATÓRIO/ PONTO FIXO
FREIO DE EMERGÊNCIA
LUNETTA FIXA/ MÓVEL
BANCADA MONOBLOK DE FUNDIÇÃO
TORRETA C/ RÁPIDO 4 PORTADORES
EQUIPAMENTO DE REFRIGERAÇÃO
LÂMPADA DE TRABALHO
CERTIFICADO CE

CE500/2000
2 METROS

€ 35.780





MANDRILADORA PORTÁTIL MULTIFUNÇÕES SUPERCOMBINATA EASY



TRABALHO EM Ø 32 A Ø 250
EQUIPADA COM MOTOR DE 1800 W
2 VELOCIDADES - 120 E 400 RPM
TODA A LINHA DOS EQUIPAMENTOS ELSA
SÃO COMPATÍVEIS COM QUALQUER MÁQUINA
DE SOLDAR MIG/MAG DE LIGAÇÃO EURO

SC140/1-E € 15.600

€ 1.196

MANDRILADORA PORTÁTIL MULTIFUNÇÕES SUPERCOMBINATA



TRABALHO DE 42MM A 400MM (1,65" - 15,75")
EQUIPADA COM MOTOR DE 1800W
4 VELOCIDADES - 400 Nm COM 95RPM
TODA A LINHA DOS EQUIPAMENTOS ELSA
SÃO COMPATÍVEIS COM QUALQUER MÁQUINA
DE SOLDAR MIG/MAG DE LIGAÇÃO EURO

SC 140/1-P-V4

€ 19.850

Otimizamos a sua produção ao máximo

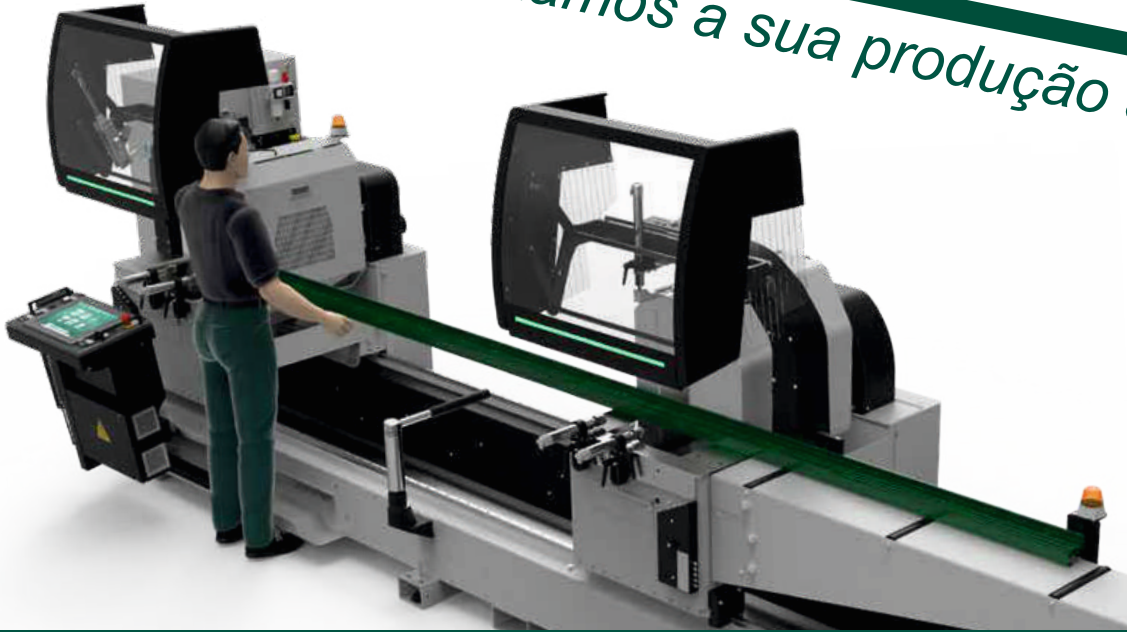

FomGroup

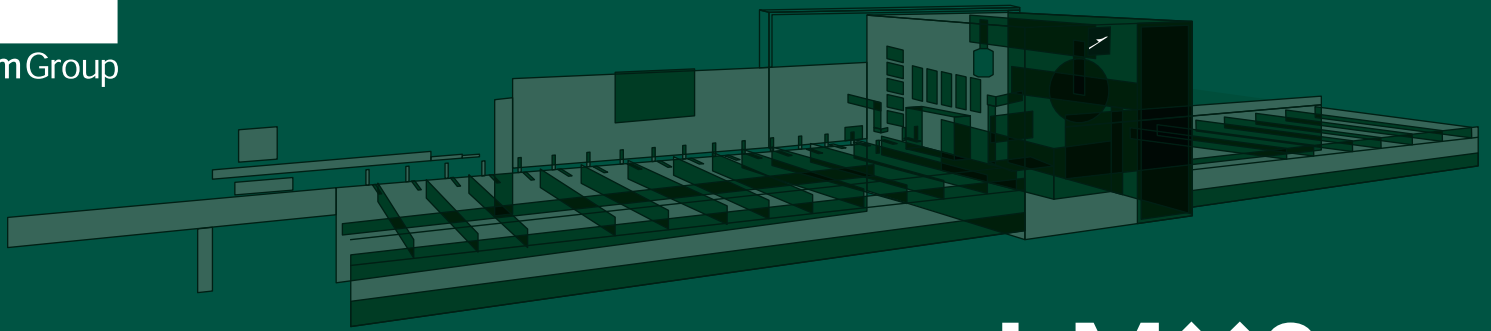

LMx2
650

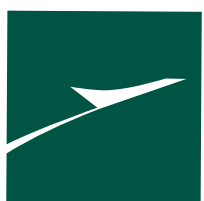

FomIndustrie
Aluminium Working Machinery



MÁQUINAS PARA ALUMÍNIO

FomIndustrie
Aluminium Working Machinery

ALVA 50

INCLUI SOFTWARE DE CORTE DE MEDIDAS ESPECIAIS, MEDIDOR DE ALTURA DE PERFIL E SISTEMA DE CORTE PASSO A PASSO



SERROTE DE DUAS CABEÇAS COM LÂMINAS DE CARBONETO DE TUNGSTÊNIO Ø 500 MM COM MOVIMENTO MOTORIZADO DO CABEÇOTE MÓVEL E CONTROLO ELECTRO-PNEUMÁTICO DA INCLINAÇÃO DO CABEÇOTE.
DISPONÍVEL VERSÕES DE 5 E 6.6 METROS SOB CONSULTA

XZ-10784 - 4 METROS

€ 33.330

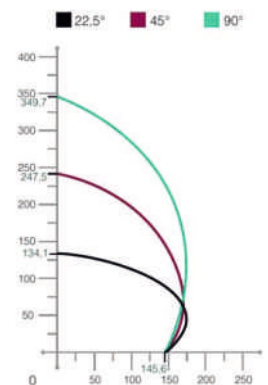

ALVA 55



SERROTE DE DUAS CABEÇAS COM LÂMINAS DE CARBONETO DE TUNGSTÊNIO Ø 500 MM COM MOVIMENTO MOTORIZADO DO CABEÇOTE MÓVEL E CONTROLO ELECTRO-PNEUMÁTICO DA INCLINAÇÃO DO CABEÇOTE.

SOFTWARE DE CORTE PASSO A PASSO INCLUÍDO
SOFTWARE DE CORTE PARA MEDIDAS ESPECIAIS
MEDIDOR ELETRÓNICO DE ALTURA DE PERFIL
DISPONÍVEL VERSÕES DE 5 E 6.6 METROS SOB CONS.
SOFTWARE VISUALIZAÇÃO E DESTAQUE SECÇÕES PERFIL EM DXF

XZ-10726- 4 METROS € 47.500

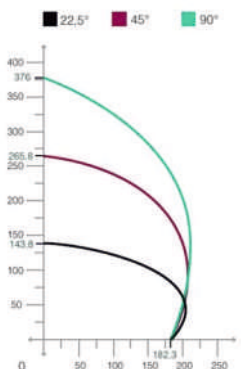



PANTÓGRAFO ELECTROPNEUMÁTICO
P/ ALUMÍNIO E PVC

CALCO

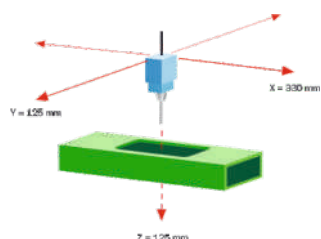

XX11145

€ 3.300

- ACOPLAMENTO DE FERRAMENTA ER 16
- 2 MORSAS HORIZONTAIS COM VÁLVULAS DE SEGURANÇA
- SISTEMA DE LUBRIFICAÇÃO DE LÂMINA POR PULVERIZAÇÃO
- MARCADOR PNEUMÁTICO COM SELETOR DE DIÂMETRO DUPLO DE Ø 5 E Ø 8 MM
- MOTOR TRIFÁSICO DE 0,75 KW 230/400 V - 50 HZ
- FILTRO DE AR, BROCA DE FRESA: Ø 8 MM - 8 MM TANG
- PINÇA ER 16 PARA BROCA DE FRESAGEM: Ø 8 MM
- 2 PLACAS GABARITOS

MÁQUINA DE CORTE
E DESBASTE



DUMBO

XZ10085

€ 2.700

- SERRA DE TUNGSTÊNIO DE Ø300
- ALTURA MÁXIMA 104 MM
- PROTEÇÃO DE SEGURANÇA DA LÂMINA DE SERRA
- TRANSMISSÃO DE MOTOR DE CORREIA
- TRIFÁSICO - 2 HP - 2800RPM
- MANDRIL DE RETENÇÃO DE LÂMINA DE SERRA Ø32MM
- 7 BAR



EMALHETADEIRA PNEUMÁTICA JET

XX11068

€ 3.500

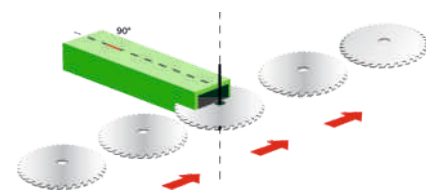

- ÂNGULO DE FRESAGEM DE TOPO DE 90°
- VELOCIDADE DA UNIDADE DA FERRAMENTA DE FRESAGEM 2800 RPM
- TAMANHO MÁX. DA FERRAMENTA DE FRESAGEM Ø 130 MM
- SISTEMA DE BALANCEAMENTO DA UNIDADE DE FERRAMENTA DE FRESAGEM
- ARMAZÉM DE CORTADORES COM 3 CAIXAS
- SISTEMA DE LUBRIFICAÇÃO DE LÂMINA POR PULVERIZAÇÃO
- PERCURSO CARRO: X MAX = 244 MM
- PROFUNDIDADE DE FRESAGEM: Y MAX = 44 MM
- ALTURA MÁXIMA DA UNIDADE DE FRESAGEM: Z = 125 MM
- ALTURA DO TAMPO 852 MM
- PREPARADO PARA EXTRACÇÃO DE LIMALHAS E GASES
- TRAVA DE ABERTURA DE SEGURANÇA
- PRESSÃO DE TRABALHO DUPLA SERVOCONTROLADA EM BAIXA PRESSÃO
- INCLUI: LUVA DE CORTE PARA UNIDADES DE FRESAGEM
- MORSAS HORIZONTAIS E VERTICAIS



MÁQUINAS PARA ALUMÍNIO

FomIndustrie
Aluminium & PVC Working Machinery

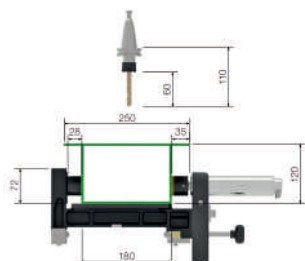
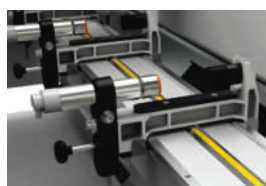

CENTRO DE MAQUINAÇÃO FMC 120



INCLUI:

- 4 MORSAS PNEUMÁTICAS
- POSICIONAMENTO AUTOMÁTICO DAS 4 MORSAS - PR207680
- CARROSSEL DE 5 POSIÇÕES COM MUDANÇA DE FERRAMENTA AUTOMÁTICA - PR204851
- MESA COM POSICIONADOR MANUAL DE ANGULOS INTERMÉDIOS - PR28965
- MÓDULO 2D PARA FSTCAM4 - ZP714617
- CONE ISO 30 COM DISCO DE CORTE Ø75 - 6 MM - QN28849
- KIT FERRAMENTAS DE ALUMÍNIO TIPO 1 - PR27602
- BATENTE EXTERNO COM TÚNEL - Pr204833

XX100329 € 63.790

FomIndustrie Aluminium & PVC Working Machinery

CENTRO DE MAQUINAÇÃO FMC - 470

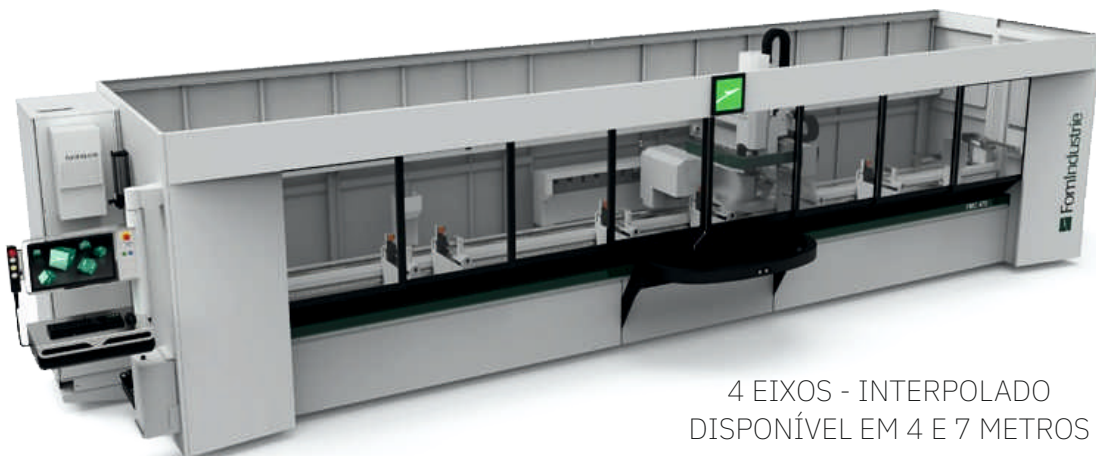
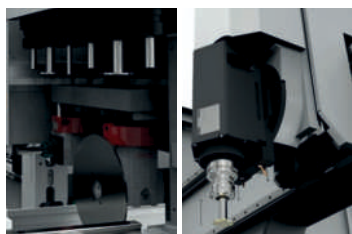

4 EIXOS - INTERPOLADO
DISPONÍVEL EM 4 E 7 METROS

- SPINDLE DE 7 KW REFRIGERADO A ÁGUA
20000 RPM MAX
- 4 EIXOS DE MAQUINAÇÃO
- DIREÇÃO DO LUBRIFICANTE AUTOMÁTICA - XFLOW
- 2 ZONAS DE TRABALHO
- CARROSSEL DE 9 POSIÇÕES + 8 OPCIONAIS

- 2 BATENTES PNEUMÁTICOS AUTOMÁTICOS
- MEDIDOR DE COMPRIMENTO DE PERFIL AUTOMÁTICO
- ATÉ 8 MORSAS - 4 POR ÁREA DE TRABALHO
- CHASSIS ROBUSTO PATENTEADO
- CONSOLA DE CONTROLO AJUSTÁVEL
- COMANDO DE CONTROLO PORTÁTIL
- LEDS INDICADORES DE TRABALHO

PREÇO SOB CONSULTA





SPRING 45 E

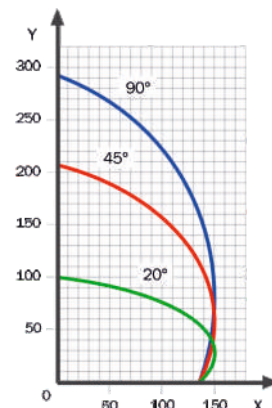
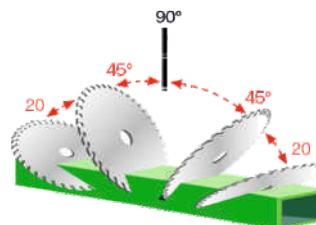

MÁQUINA DE CORTE DE CABEÇOTE SIMPLES DE Ø 450 MM COM AVANÇO DO DISCO DE TRÁS PARA FRENTE MOVIMENTO FRONTAL COM INCLINAÇÃO PNEUMÁTICA DE 20° A 90° ESQUERDA E DIREITA COM PROTECÇÃO FRONTAL

Xz10677

€ 9.000

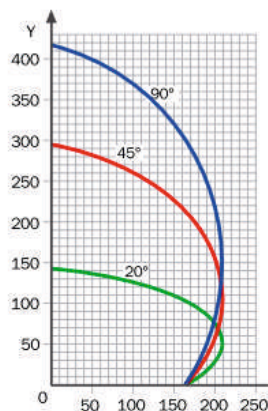

SPRING 55

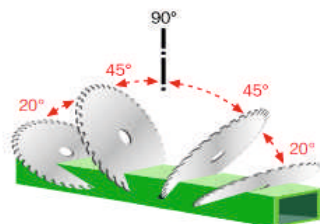

MÁQUINA DE CORTE DE DE LÂMINA FRONTAL DE Ø 550 MM CONTROLE ELETROPNEUMÁTICO DA INCLINAÇÃO DA CABEÇA DE 20° A 90° ESQUERDA E DIREITA SISTEMA DE LUBRIFICAÇÃO DE LÂMINA



XZ10304

€ 17.000



MANDRILADORA E FRESADORA



LÂMINA DE CORTE DE TUNGSTÊNIO Ø 400 MM
KIT DE PROTEÇÃO DE ÁREA DE CORTE INTEGRAL
2 TORNOS PNEUMÁTICOS HORIZONTAIS
LUBRIFICAÇÃO DE FERRAMENTA

SIKA PLUS MANUAL

DISPONÍVEL NAS VERSÕES PNEUMÁTICA E MANUAL

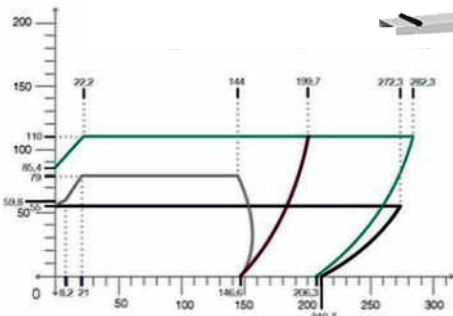

PREPARADO PARA EXTRACÇÃO DE LIMALHAS E FUMOS
ÂNGULOS INTERMÉDIOS COM BATENTE MECÂNICO
ÂNGULO DE CORTE LD A 45° E LE A 45° NO EIXO VERTICAL

400 V - 2.2 KW

XZ100228 € 5.200

ESPERAS DE CARGA (ENTRADA)

SPEEDY WORK



ESPERAS DE CARGA (ENTRADA)

ASSOMAK



- MESA DE ROLOS COM POSICIONAMENTO MANUAL
- CORTE MÍNIMO 0 MM
- LARGURA DA SUPERFÍCIE DE APOIO DA BARRA: 200 MM
- CAPACIDADE DE CARGA POR METRO LINEAR: 3 KG
- KIT DO BATENTE DE ACERTO MANUAL
- BATENTE DE COMPRIMENTO PATENTEADO COM SUPERFÍCIE DE DESLIZAMENTO SOB A MESA DE TRABALHO, PARA FORNECER UMA REFERÊNCIA CONSTANTE EM TODAS AS CONDIÇÕES DE TRABALHO

- MESA DE ROLOS COM POSICIONAMENTO MANUAL
- CORTE MÍNIMO 0 MM
- LARGURA DA SUPERFÍCIE DE APOIO DA BARRA: 200 MM
- CAPACIDADE DE CARGA POR METRO LINEAR: 10 KG
- BATENTE DE ACERTO PNEUMÁTICO
- POSICIONE A LEITURA NA FITA MILIMÉTRICA USANDO UMA LUPA ESPECIAL
- BATENTE DE COMPRIMENTO PATENTEADO COM SUPERFÍCIE DE DESLIZAMENTO SOB A MESA DE TRABALHO, PARA FORNECER UMA REFERÊNCIA CONSTANTE EM TODAS AS CONDIÇÕES DE TRABALHO

XK201566 € 945 3 MTS

XK201567 € 1.070 4 MTS

XK100166 € 1.895 3 MTS

XK100168 € 2.130 4.2 MTS

XK100170 € 2.675 6 MTS

ESPERAS DE CARGA (SAÍDA)

PORTER

- CAPACIDADE DE CARGA POR METRO LINEAR: 3KG
- ROLETES DE PLÁSTICO

XK201568 € 670 3 MTS

XK201569 € 770 4.2 MTS

XK202576 € 1.320 6 MTS



OPCIONAL:
KIT DE CONEXÃO PARA MESA DE ROLETES DE CARGA DA SPRING 55/45

XK201577 € 1.320 6 MTS



MÁQUINAS PARA ALUMÍNIO E PVC

profteQ
made in Italy evolution on pvc windows

PINÇA DE 8MM
4 APERTOS PNEUMÁTICOS
3 COPIADORES DE 3 DIAMETROS: 5/8/10MM
5 BATENTES DE REGULAÇÃO
3 CHAPAS COPIADORAS STANDARD
LUBRIFICAÇÃO PNEUMÁTICA
FILTRO DE AR
PISTOLA DE AR

Mepal
Italia

EGO3000
COPY ROUTER

€ 14.990

PANTÓGRAFO AUTOMÁTICO
COM MESA ROTATIVA

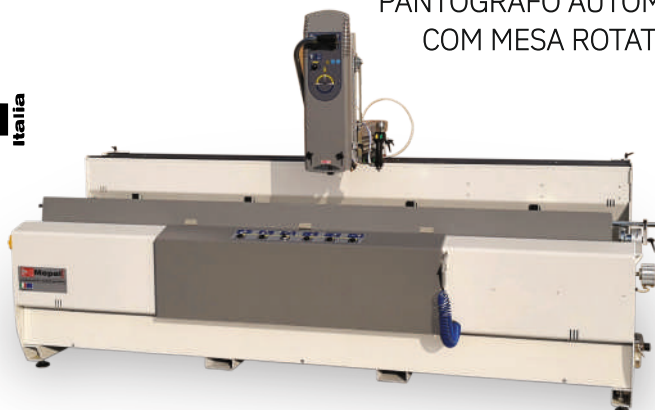

CENTRO DE FRESAGEM MANUAL A 3 EIXOS C/ LUBRIFICAÇÃO PNEUMÁTICA E 3 COPIADORES PNEUMÁTICOS. DOTADO DE MESA PNEUMÁTICA GIRATÓRIA -90°/0°/+90° COM ESCALA PARA A REGULAÇÃO DOS GRAUS INTERMÉDIOS. SISTEMA FÁCIL E RÁPIDO NO POSICIONAMENTO DOS COPIADORES. EQUIPADO COM UM SPINDLE C/VELOCIDADE VARIÁVEL QUE PODE IR DE 2800 A 12000 RPM, COM MOTOR TRIFÁSICO 1,1 KW. CAPACIDADE DE TRABALHO A 0° É DE 3000X250X200MM. MOVIMENTO EIXO X EM GUIAS LINEARES. MÁQUINA INDICADA PARA TRABALHAR ALUMÍNIO, PVC, AÇO INOX E FERRO.

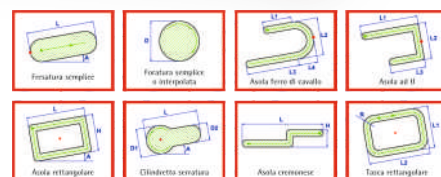

profteQ
made in Italy evolution on pvc windows

SOLDADOR AUTOMÁTICO 1 CABEÇA



PRENSAS PARA ALUMÍNIO

PRENSA PH 8 FIXA

€ 3.400

PRENSA GIRATÓRIA

€ 4.800



SOLDAGEM DE 90° E CANTOS VARIÁVEIS COM CICLO CONTROLADO POR PLC. AQUECIMENTO UNIFORME DA PLACA POR SERPENTINA.

BRAÇOS DE SUPORTE PARA SOLDAGEM DE DOIS CANTOS. LIMITADORES EM INOX AQUECIDOS E PRÉ-REGULADOS (0,6 MM). PLACA DE BATENTE FORNECIDA PARA CONTRAÇÃO DE 5 MM.

€ 11.250

profteQ
made in Italy evolution on pvc windows

profteQ
made in Italy evolution on pvc windows

SOLDADOR AUTOMÁTICO 2 CABEÇAS



SOLDADURA A 90° E ÂNGULOS VARIÁVEIS (DE 45° A 180° NA CABEÇA MÓVEL DIREITA)
CICLO DE TRABALHO COM PLC
AJUSTE DE TEMPO DE FUSÃO DE ACORDO COM PERFIS EXISTENTES NO MERCADO
AQUECIMENTO DA PLACA UNIFORME POR SERPENTINA
DESLOCAÇÃO DA CABEÇA EM GUIAS TEMPERADAS E CROMADAS
ROLAMENTOS CILÍNDRICO DE ESFERAS
POSICIONAMENTO DE PRECISÃO
COMANDOS NOS DOIS PAINÉIS - SISTEMA DE TROCA RÁPIDA DO TEFLON

LINK 45

€ 24.800





LINHA PROMOVER

profteQ
made in Italy evolution on pvc windows

FRT5/CORNERLAB20

LINHA AUTOMÁTICA COM SOLDADURA DE 2 CABEÇAS E GRUPO DE LIMPEZA PARA UMA PRODUÇÃO ESTIMADA DE 120 QUADROS POR CADA 8 HORAS DE TRABALHO COM APENAS UM OPERADOR.

€ SOB CONSULTA

profteQ



MAQUINA LIMPEZA CANTOS
INCLUI SUPORTE PERFIS KIT03BR
MANGA CORTE AH06A001 E AH00A003

2 CABEÇAS DE LIMPEZA DE TROCA RÁPIDA
CICLO DE TRABALHO SEMI-AUTOMÁTICO
PONTO 0 NO EXTERIOR DO PERFIL
PREPARADO PARA PERFIL COM FOLHA ACRÍLICA

UN4FA

€ 9.250

profteQ

APARAFUSADORA COM ALIMENTAÇÃO AUTOMÁTICA

AF1

€ 9.450

BLOQUEIO DE PERFIL E APARAFUSAMENTO COM PEDAL
CARREGAMENTO AUTOMÁTICO DE PARAFUSOS
POSSIBILIDADE DE UTILIZAR VÁRIAS MEDIDAS DE PARAFUSOS
REFORÇOS DE 0.5 A 2.5 MM DE ESPESSURA
AJUSTE DE FORÇA DE APERTO
PREGUIÇAS DE CARREGAMENTO INCLUIDAS
BASE INCLUIDA

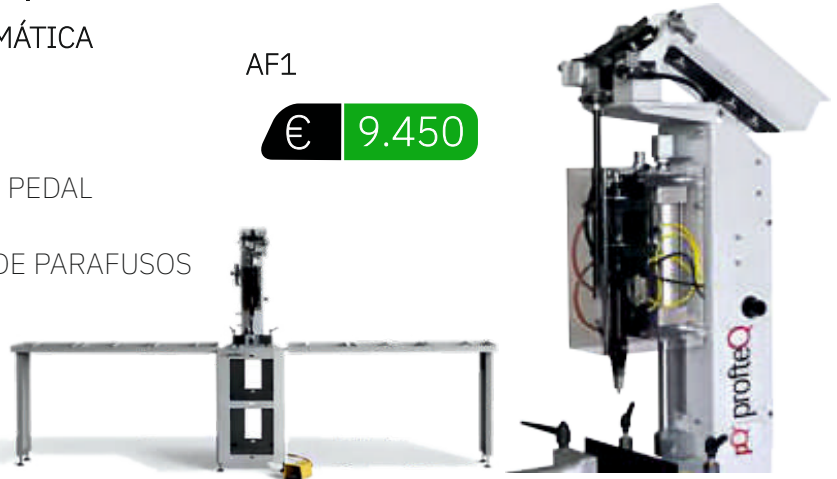

profteQ

SERRA SEMI AUTOMÁTICA -
COM ESPERAS DIREITA
E ESQUERDA INCLUIDAS (KIT16SX E KIT16DX)
SERRA PARA CORTAR BITES PVC
COM ESPERAS DE 1650 MM E 3000 MM



STD16

€ 10.200

FRESADORA CONDENSAÇÃO
4 MOTORES

CICLO DE TRABALHO TOTALMENTE AUTOMÁTICO
AJUSTE DA INCLINAÇÃO LONGITUDINAL / TRANSVERSAL
AJUSTE DA PROFUNDIDADE DA FRESAGEM
REFERÊNCIAS INDEXADAS PARA AJUSTE ANGULAR
DO MOTOR DO CABEÇOTE DIANTEIRO
REFERÊNCIA DO PERFIL INTERNO DE PONTO ZERO



DR 4

€ 9.650



MOVIMENTAÇÃO E ELEVAÇÃO DE VIDROS

CARRO DE MANUSEAMENTO DE VIDROS PS 900800

PETER[®]
PROFESSIONAL EQUIPMENT

O carro de manuseamento de vidros PS900 da marca PETER foi desenvolvido para responder às exigências crescentes da indústria de caixilharias e janelas. Este equipamento foi concebido para oferecer fiabilidade, eficiência e precisão para a montagem de janelas de grande dimensão e elevado peso.



Carga Máxima:
800kg



Nº de ventosas / Tamanho:
8 / Ø300mm



Altura de trabalho:
5000mm



**Faixa de rotação 360°
Alcance Giratório 90°**



Ajuste de velocidade:
Contínuo



Bateria:
2x12V / 120ah



Motor de tração:
24V / 2500W



Tipo de travão:
Electromagnético



Corrente de carga:
24V / 18A



Peso da máquina:
2080kg



Tração:
Dianteira



Tamanho:
3180x1100x1780mm



Nº Rodas / Tamanho:
Dianteiras: 2 (Opção: 2+2) / Ø466x195mm
Traseiras: 2 / Ø400x100mm

€ 38.800

CARRO DE MANUSEAMENTO DE VIDROS PS 900600



Carga Máxima:
600kg



Nº de ventosas / Tamanho:
6 / Ø300mm



Altura de trabalho:
3800mm



**Faixa de rotação 360°
Alcance Giratório 90°**



Ajuste de velocidade:
Contínuo



Motor de tração:
24V / 2200W



Corrente de carga:
24V / 18A



Tipo de travão:
Electromagnético



Peso da máquina:
1850kg



Tamanho:
2780x990x1750mm



Nº Rodas / Tamanho:
Dianteiras: 2 (Opção: 2+2) / Ø466x195mm
Traseiras: 2 / Ø400x100mm



€ 31.500



ELEVADOR A VÁCUO COM 8 VENTOSAS PS 500800

O PS500 é uma solução avançada e eficiente concebida para o manuseio, carga e descarga de vidros, vidraças e chapas. Este equipamento versátil é ideal para trabalhar com todo o tipo de superfícies lisas, garantindo segurança, precisão e praticidade em cada operação. desenvolvido para responder às exigências crescentes da indústria de caixilharias e janelas.

 Carga Máxima: 800kg	 Tipo: DC 12 elétrico
 Nº de ventosas / Tamanho: 8 / Ø300mm	 Peso da máquina: 100kg
 Rotação: Manual de 360°	 Tamanho: 1900x1580x200mm
 Inclinação: Manual de 90°	 Barra de extensão: 500mm
 Corrente de carga: AC 220V/110V	 Sistema de controlo: Painel de controlo integrado Controlo remoto com fios



€ 4.550





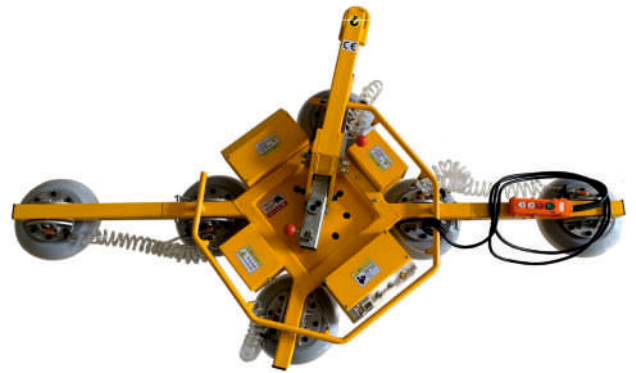





ELEVADOR A VÁCUO COM 6 VENTOSAS PS 500600

 Carga Máxima: 600kg	 Tipo: DC 12 elétrico
 Nº de ventosas / Tamanho: 6 / Ø300mm	 Peso da máquina: 90kg
 Rotação: Manual de 360°	 Tamanho: 2370x1030x200mm
 Inclinação: Manual de 90°	 Barra de extensão: 500mm
 Corrente de carga: AC 220V/110V	 Sistema de controlo: Painel de controlo integrado Controlo remoto com fios



€ 4.100

ELEVADOR A VÁCUO COM 4 VENTOSAS PS 500400

 Carga Máxima: 400kg	 Tipo: DC 12 elétrico	 Corrente de carga: AC 220V/110V
 Nº de ventosas / Tamanho: 4 / Ø300mm	 Peso da máquina: 70kg	 Barra de extensão: 500mm
 Rotação: Manual de 360°	 Inclinação: Manual de 90°	 Tamanho: 870x770x200mm
 Sistema de controlo: Painel de controlo integrado Controlo remoto com fios		

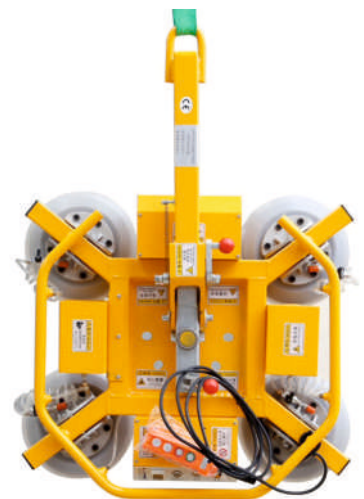

€ 3.700





ORLADORA

PRÉ-FRESAGEM INCLUÍDA
COLAGEM COM COLA POLIURETANO (OPCIONAL)
3 ESPAÇOS LIVRES PARA UNIDADES DE ACABAMENTO

VELOCIDADE DE ALIMENTAÇÃO DE 7MT/MIN
10 A 45 MM DE ALTURA DO PAINEL
0.4 A 2 MM DE ESPESSURA DE ORLA EM BOBINE
DIÂMETRO MÁXIMO DA BOBINE 800
110 MM DE COMPRIMENTO MÍNIMO DO PAINEL
2300 METROS ÚTIL
LARGURA MÍNIMA 95 MM
CAPACIDADE RECIPIENTE DA COLA - 1 KG



E 350 PM

€ 14.384

OPCIONAIS DISPONÍVEIS:

LORASB - GRUPO RASPADOR DE BORDO

€ 1.852

LORSCL - GRUPO RASPADOR DE COLA

€ 777

LOSPA3 - GRUPO LIMPEZA COM ESCOVA

€ 777

HF 12000 RPM

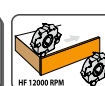
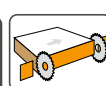
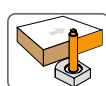
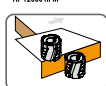

PAINEL TOUCH



ORLADORA CASADEI



ORLADORA COM TUPIAS DE ENTRADA

E 550 F

€ 21.045

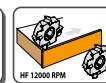
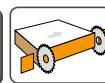
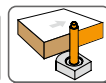
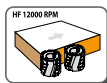

ORLADORA COM TUPIAS DE ENTRADA E GRUPO ARREDONDADOR

E 550 CRF

€ 28.473

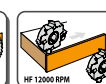
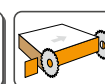
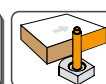
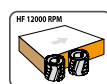

COMPRIMENTO - PM - 3.2 MT
- PMCR 3.7 MT

VELOCIDADE DE ALIMENTAÇÃO - 9 M / MIN
ESPESSURA DO PAINEL MÍN. 8 - MÁX. 50 MM

COMPRIMENTO MÍNIMO PAINEL - 110 MM
LARGURA MÍNIMA - 70MM
DIÂMETRO MÁXIMO DO ROLO - 800 MM
1315W DE AQUECIMENTO - 6 CARTUXOS
POTENCIA TOTAL 5KW APROX.

OPCIONAIS DISPONÍVEIS:

LORASB - GRUPO RASPADOR DE BORDO

€ 1.852

LORSCL - GRUPO RASPADOR DE COLA

€ 777

LOSPA3 - GRUPO LIMPEZA COM ESCOVA

€ 777





ESQUADREJADORA PROFISSIONAL



ESQUADREJADORA PROFISSIONAL C/
SUBIDA, DESCIDA E INCLINAÇÃO ELÉTRICA DO DISCO
AJUSTE MANUAL DO CORTE PARALELO
CARRO DESLIZANTE 3200X896 MM
DIMENSÃO DA MESA DE FERRO FUNDIDO 548X896 MM
CORTE PARALELO DA MESA LATERAL 952X830 MM
BARRA DE CORTE PARALELA 50 MM
DISCO Ø400 MM
CORTE MAX 90° 125 MM
CORTE MAX 45° 90 MM
POTÊNCIA DO MOTOR 7.5HP
POTÊNCIA DO MOTOR DO INCISOR 1.0 HP
VELOCIDADE DO DISCO 3000/4000/5000
AJUSTE DE CORTE PARALELO MANUAL
AJUSTE DE INCLINAÇÃO DO DISCO MOTORIZADO
AJUSTE DE SUBIDA E DESCIDA DO DISCO MOTORIZADO
INCISOR Ø120MM

D-400 A2

€ 12.800



O MODELO MAIS AVANÇADO DA SERIE D PROFISSIONAL.
REUNE AS MAIORES NOVIDADES DE TECNOLOGIA DE ALTA GAMA, TENDO UM
RESULTADO EXCELENTE NA SUA PRODUÇÃO.
COM A SUBIDA, DESCIDA E INCLINAÇÕES AUTOMÁTICAS, ESTE MODELO
TEM TAMBÉM O POSICIONAMENTO DA PARALELA AUTOMÁTICO QUE
TRADUZ O CORTE COM ALTA PRECISÃO, CÓMODO E RÁPIDO.

ESQUADREJADORA PROFISSIONAL

ESQUADREJADORA PROFISSIONAL
ELETRÓNICA C/ SUBIDA, DESCIDA
E INCLINAÇÃO ELÉTRICA DO DISCO

AJUSTE ELÉTRICO DO CORTE PARALELO

CARRO DESLIZANTE 3200X395 MM
DIMENSÃO DA MESA DE FERRO FUNDIDO 548X896 MM
CORTE PARALELO DA MESA LATERAL 952X830 MM
BARRA DE CORTE PARALELA 50 MM
DISCO Ø400 MM
CORTE MAX 90° 125 MM
CORTE MAX 45° 90 MM
POTÊNCIA DO MOTOR 7.5HP
POTÊNCIA DO MOTOR DO INCISOR 1.0 HP
VELOCIDADE DO DISCO 3000/4000/5000
AJUSTE DE CORTE PARALELO MOTORIZADO
AJUSTE DE INCLINAÇÃO DO DISCO MOTORIZADO
AJUSTE DE SUBIDA E DESCIDA DO DISCO MOTORIZADO
INCISOR Ø120MM



OPCIONAL:

MEDIDOR DIGITAL DE
ÂNGULOS DE ESQUADRIA
E INCLINAÇÃO

D-400 A3N

€ 24.900



ASPIRAÇÃO PARA APARAS

ASPIRADOR DE ACOPLAMENTO A ESQUADREJADORAS

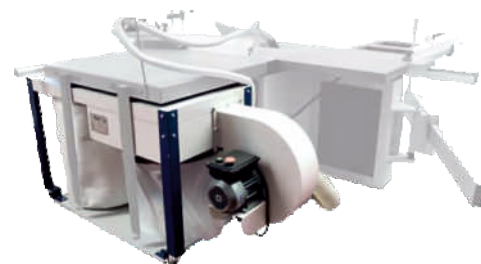

POTÊNCIA MOTOR 1.5 HP
ASPIRAÇÃO 1.300 M3/H
Ø VENTILADOR 330 MM (METAL)
Ø SACOS 1 - 500X500 MM
Ø FILTROS 1 - 500X600
Ø TOMA DE ASPIRAÇÃO - 120 MM
NÍVEL SONORO - 85db
1.600x563x750 MM
PESO 60 KG

DE-1300

€ 765



POTÊNCIA MOTOR 3 HP
ASPIRAÇÃO 2.500 M3/H
Ø VENTILADOR 300 MM (METAL)
Ø SACOS 1 - 500X850 MM
Ø FILTROS 1 - 500X850 MM
Ø TOMA DE ASPIRAÇÃO - 2X100 MM
NÍVEL SONORO - 85db
850X560X1.860 MM
PESO 50 KG

DE-203/1

€ 490

1107026 - MONOFÁSICO

DE-203/3

€ 490

1107028 - TRIFÁSICO



POTÊNCIA MOTOR 3 HP
ASPIRAÇÃO 3.600 M3/H
Ø VENTILADOR 300 MM (METAL)
Ø SACOS 1 - 500X850 MM
Ø FILTROS 1 - 500X850 MM
Ø TOMA DE ASPIRAÇÃO - 3X100 MM
NÍVEL SONORO - 85db
1.460x720x2.160 MM
PESO 60 KG

DE-300/1

€ 680

1107022 - MONOFÁSICO

DE-300/3

€ 680

1107014 - TRIFÁSICO





POTÊNCIA MOTOR 5.5 HP
ASPIRAÇÃO 4.600 M3/H
Ø VENTILADOR 355 MM (METAL)
Ø SACOS 3 - 510X1.200 MM
Ø FILTROS 3 - 510X1.200 MM
Ø TOMA DE ASPIRAÇÃO - 4X100 MM
NÍVEL SONORO - 80db
2.150X600X2.300 MM
PESO 140 KG

DE-550/3

€ 1.440
TRIFÁSICO



POTÊNCIA MOTOR 7.5 HP 400V
ASPIRAÇÃO 5.800 M3/H
Ø VENTILADOR 360 MM (METAL)
Ø SACOS 4 - 500X850 MM
Ø FILTROS 4 - 500X1200 MM
Ø TOMADA DE ASPIRAÇÃO - 4X100 MM
Ø BOCA DE ASPIRAÇÃO 250 MM
NÍVEL SONORO - 80db
2.700X600X2.300 MM
PESO 160 KG

DE-750/3

€ 1.790



POTÊNCIA MOTOR 10 HP 400V
ASPIRAÇÃO 6.350 M3/H
Ø VENTILADOR 360 MM (METAL)
Ø SACOS 4 - 500X850 MM
Ø FILTROS 4 - 500X1200 MM
Ø TOMADA DE ASPIRAÇÃO - 4X100 MM
Ø BOCA DE ASPIRAÇÃO 250 MM
NÍVEL SONORO - 80db
2.700X600X2.300 MM
PESO 170 KG

DE-1000/3

€ 2.130



ASPIRAÇÃO MANGAS FILTRANTES



ASPIRAÇÃO DE 18 MANGAS FILTRANTES
COM MOTOR DE 4HP 380V

POTÊNCIA MOTOR 4 HP
ASPIRAÇÃO 3.500 M3/H
Ø VENTILADOR 400 MM (METAL)
Ø SACOS 1 - 600X950 MM
Ø FILTROS 18- 160X935MM
Ø TOMA DE ASPIRAÇÃO - 3X120 MM
Ø BOCA DE ASPIRAÇÃO - 200MM
NÍVEL SONORO - 80db
800x1.500x2.180 MM
PESO 140KG

DE - 3500/3

€ 3.580



ASPIRAÇÃO DE 37 MANGAS FILTRANTES
COM MOTOR DE 7.5HP 380V

POTÊNCIA MOTOR 7.5 HP
ASPIRAÇÃO 5.000 M3/H
Ø VENTILADOR 500 MM (METAL)
Ø SACOS 2 - 500X900 MM
Ø FILTROS 37- 160X935MM
Ø BOCA DE ASPIRAÇÃO - 280MM
NÍVEL SONORO - 80db
970x2.100x2.150 MM
PESO 300KG

DE - 5000/3

€ 4.590



ASPIRAÇÃO DE 45 MANGAS FILTRANTES
COM MOTOR DE 10HP 380V E SISTEMA
DE AUTO LIMPEZA

POTÊNCIA MOTOR 10HP
ASPIRAÇÃO 6.500 M3/H
Ø VENTILADOR 500 MM (METAL)
Ø SACOS 2 - 600X660X660 MM
Ø FILTROS 45- 160X935MM
Ø BOCA DE ASPIRAÇÃO - 300MM
NÍVEL SONORO - 80db
2.270x940x2.300 MM
PESO 425KG

DE - 6500/2C

€ 9.250

WD - SAC 6500P - PACK SACOS PLÁSTICO
D-600 X 1200M

€ 39.00

WD - FIL 6500 - FILTRO TELA
D-160 X 935MM PARA PÓ FINO
E MADEIRA

€ 39.00